



# ACADEMY

## **Rubinerie:**

analisi tecnica approfondita

## **Taps:**

technical in-depth analysis

**Le collezioni / the collections**

**a disposizione del progettista / available to the designer**



**Fez 2**



**Limón**



**Memory**



**Memory Mix**



**Sen**



**Square**

# Fez 2

## Rubinetteria / taps

Fez 2



design Benedini Associati, 1999-2018



## Fez 2: migliorie estetiche / Fez 2: aesthetic improvements

### **Maniglia ridimensionata con ergonomia migliorata /**

Resized handle with improved ergonomics

### **Corpo maniglia cilindrico invece che troncoconico /**

Cylindrical handle body instead of truncated cone

### **Monoblocco cromato o verniciato /**

Chromed or painted monobloc

### **Unificazione ghiera a parete con stesso diametro e più sottili /**

Unification of wall ring nuts with the same diameter and thinner

### **Nuova curva per la bocca /**

New curve for the spout



## Fez 2: migliorie tecniche / Fez 2: technical improvements

### Nuovi incassi / New built-in

**Fusione unica in ottone / One piece brass casting**

**Controcassa in polistirolo per migliorare le prestazioni in termini di riduzione della rumorosità e delle vibrazioni /**

Polystyrene outer casing to improve performance in terms of reducing noise and vibrations

**Involucro in plastica a tenuta stagna.**

**Protegge il corpo durante l'installazione e in caso di perdita /**

Watertight plastic housing.

It protects the body during installation and in case of loss.

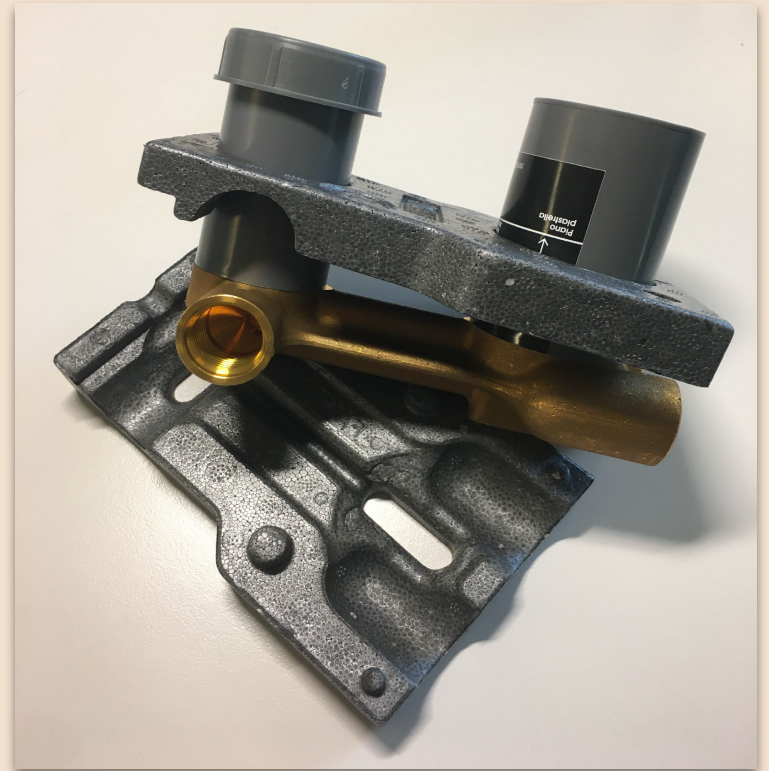

## Fez 2: migliorie tecniche / Fez 2: technical improvements

### Nuovi incassi / New built-in

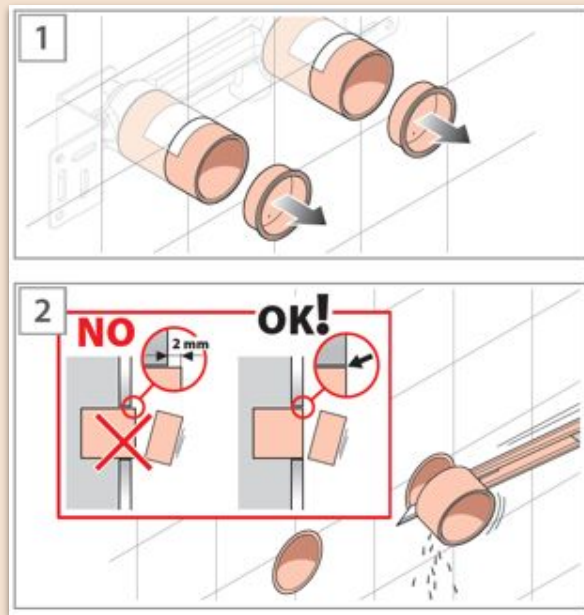
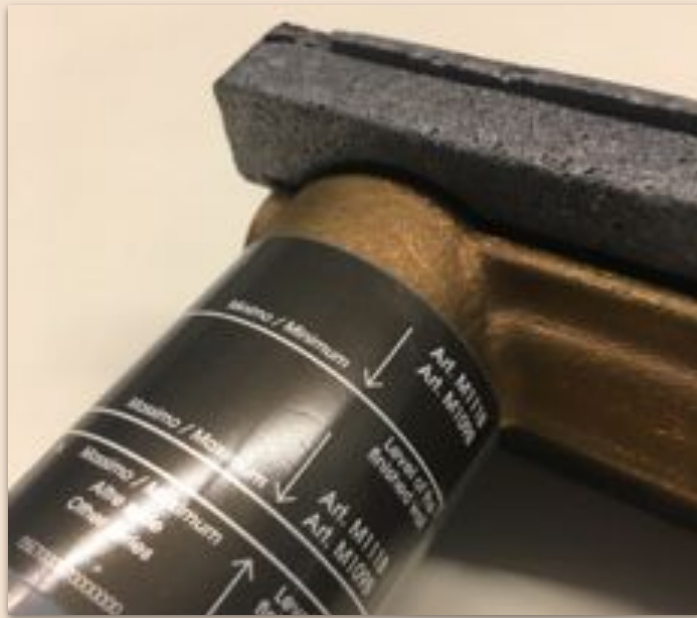

**Tappi di protezione a tenuta che sono integrati nel blocco in ottone e vengono tagliati dall'installatore a misura a parete finita mentre in precedenza venivano sfilati (con rischio di infiltrazioni) /**

Sealing protection caps that are integrated into the brass block and are cut to size by the installer when the wall is finished while previously removed (with risk of infiltration) /

## Fez 2: migliorie tecniche / Fez 2: technical improvements

### Nuovi incassi / New built-in

**Staffe di montaggio indispensabili per fissare correttamente ed in tempi rapidi il monoblocco alla muratura e/o cartongesso / Assembly brackets indispensable for fast and correct fixing of the monobloc to masonry and/or plasterboard**

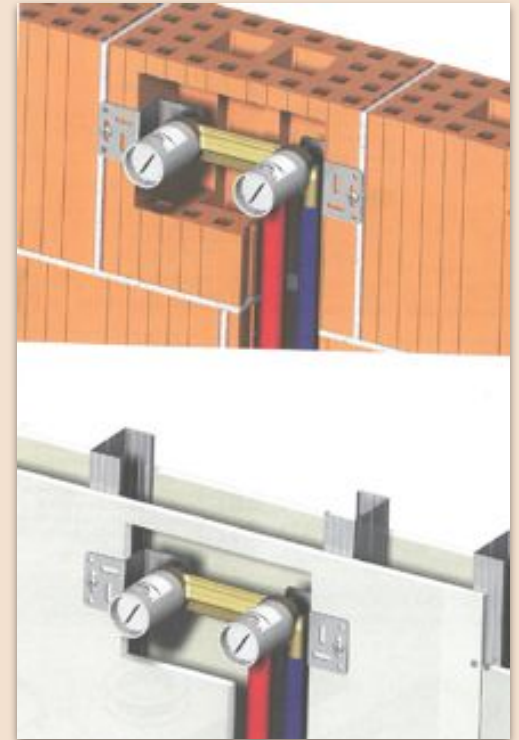
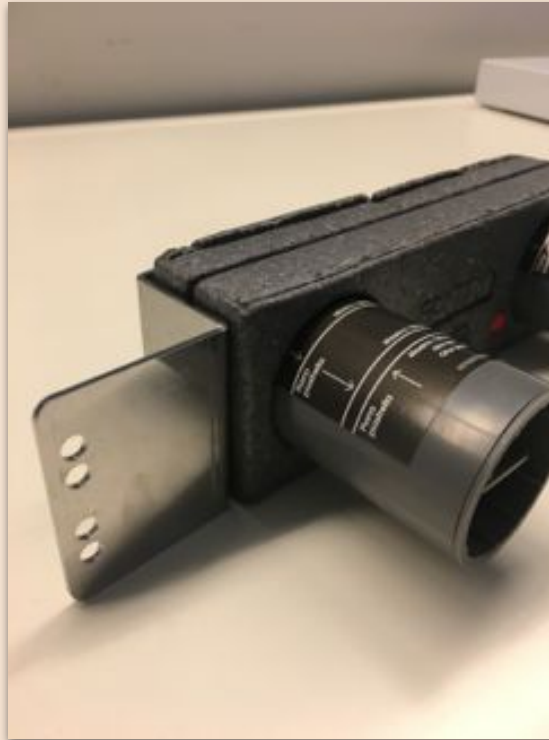

## Fez 2: finiture / Fez 2: finishes



**bianco** / white



**cromo** / chrome



**nero** / black



## Fez 2: istruzioni di montaggio / Fez 2: assembly instructions

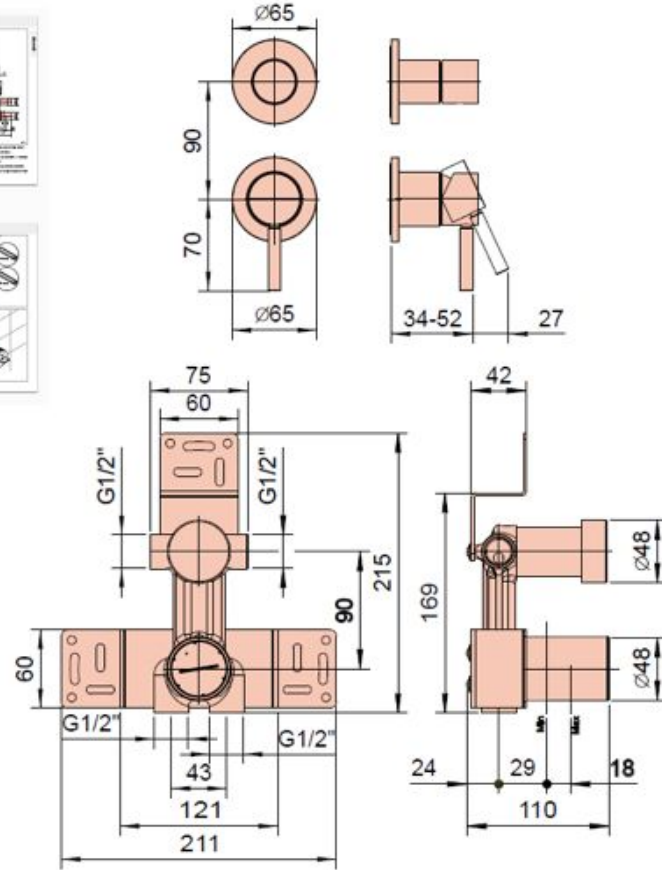
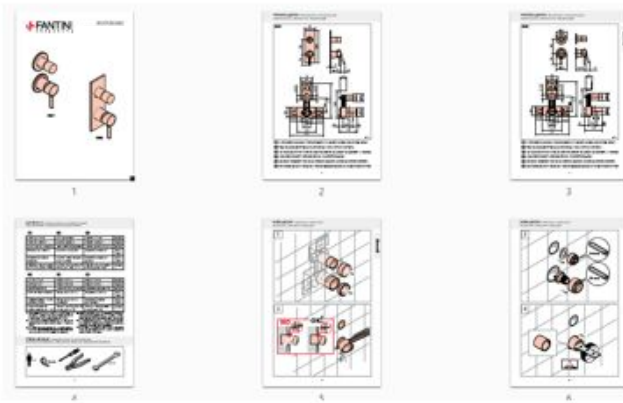

## Fez 2: garanzia / Fez 2: warranty

**TAGLIANDO DI GARANZIA  
WARRANTY CERTIFICATE  
CERTIFICAT DE GARANTIE  
GARANTIE BESCHEINIGUNG  
CERTIFICADO DE GARANTIA**

ARTICOLO \_\_\_\_\_  
ARTICLE - ARTICLE - ARTIKEL - ARTIKEL

NOME COGNOME \_\_\_\_\_  
NOMEN - NOMEN - NOMEN - NOMEN

INDIRIZZO \_\_\_\_\_  
ADRESSE - ADRESSE - ADRESSE - ADRESSE

TEL. FAX \_\_\_\_\_  
TEL - TEL - TEL - TEL - FAX - FAX

DATA D'ACQUISTO \_\_\_\_\_  
DATE - DATE - DATE - DATE - DATE - DATE

REVENDITORE \_\_\_\_\_  
HÄNDLER - HÄNDLER - HÄNDLER - HÄNDLER

DEBITO RICOSTRUTTO \_\_\_\_\_  
REPARATUR - REPARATUR - REPARATUR - REPARATUR

**COLLAUDATO  
CONTROLLATO  
OPERATORE 010C**

FANTINI S.p.A.  
Via S. Felice 1  
00144 Roma - Tel. 06/4781111 - Telex 320000  
www.fantini.it

**ISTRUZIONI DI MANUTENZIONE  
E TAGLIANDO DI GARANZIA**

**INSTRUCTIONS FOR CARE  
AND GUARANTEE**

**INSTRUCTIONS POUR L'ENTRETIEN  
ET CERTIFICAT DE GARANTIE**

**PFLEGE-UND GARANTIE  
BESTIMMUNGEN**

**INSTRUCCIONES DE MANTENIMIENTO  
Y CERTIFICADO DE GARANTIA**

**agape**

**FANTINI**

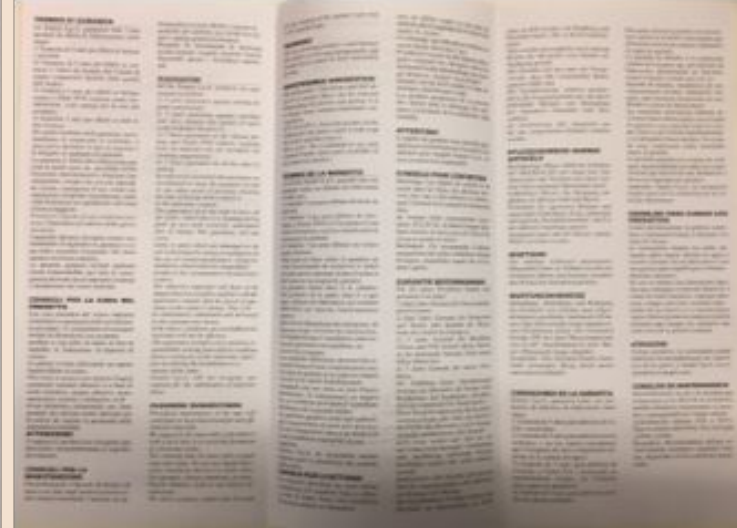



















## Fez 2: nuovo packaging / Fez 2: new packaging

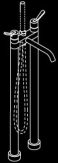

# Fez 2: abaco / Fez 2: abacus

## FEZ 2

Rubinetti gruppi lavabo	Taps washbasins taps	Armaturen Washbeckenarmaturen	Robinetterie robinetterie pour lavabos	Griferia griferia lavabo
 AFEZ001	 AFEZ002	 AFEZ003	 .EFEZ004+ .IFEZ004	 ARUB1460000
 .EFEZ011+ .IFEZ010	 .EFEZ012+ .IFEZ010			 .MET884
gruppi bidet	bidet taps	Bidetarmaturen	robinetterie pour bidets	griferia bidè
 AFEZ008				
gruppi lavabo, vasca, doccia	wash basin, bathtub, shower taps	Komponenten für Waschbecken-, Duschen-, Badewannenarmaturen	robinetterie pour lavabos, baignoires, douches	griferia lavabos, bañeras, duchas
 .EFEZ007+ .IFEZ007	 .EFEZ031+ .IFEZ031 .EFEZ021+ .IFEZ021	 .EFEZ032+ .IFEZ032 .EFEZ022+ .IFEZ022	 .EFEZ033+ .IFEZ033 .EFEZ023+ .IFEZ023	 .EFEZ034+ .IFEZ034 .EFEZ024+ .IFEZ024
 .EFEZ035+ .IFEZ035 .EFEZ025+ .IFEZ025				
gruppi vasca	bathtub tap sets	Badewannenarmaturen	robinetterie pour baignoires	griferia bañeras
 .EFEZ028+ .IFEZ028	 .EFEZ026+ .IFEZ026	 .MET885	 .EFEZ027+ .IFEZ027	

## Fez 2: gruppi lavabo / Fez 2: washbasin units



AFEZ001



AFEZ002



AFEZ003



.EFEZ004+.IFEZ004

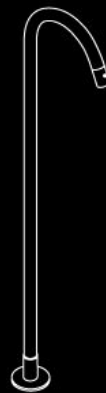

ARUB1460000

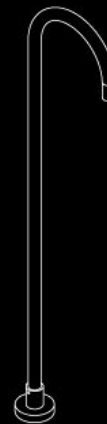

.MET884



.EFEZ011+.IFEZ010



.EFEZ012+.IFEZ010

**Fez 2: gruppi lavabo / Fez 2: washbasin units**



**finitura bianco opaco / matte white finish**

## Fez 2: gruppi lavabo, vasca e doccia / Fez 2: washbasin, bathtub and shower units



.EFEZ007+.IFEZ007



.EFEZ031+.IFEZ031  
.EFEZ021+.IFEZ021



.EFEZ035+.IFEZ035  
.EFEZ025+.IFEZ025

**miscelatore monocomando** / single lever mixer

---

**termostatico con deviatore a 2 o 3 vie e solo comando termostatico** /  
thermostatic with diverter in 2 and 3 ways version and only thermostatic control



.EFEZ032+.IFEZ032  
.EFEZ022+.IFEZ022



.EFEZ033+.IFEZ033  
.EFEZ023+.IFEZ023



.EFEZ034+.IFEZ034  
.EFEZ024+.IFEZ024

## Fez 2: termostatico con deviatore a 2 e 3 vie /

Fez 2: thermostatic built-in mixer tap with two and three-way diverter

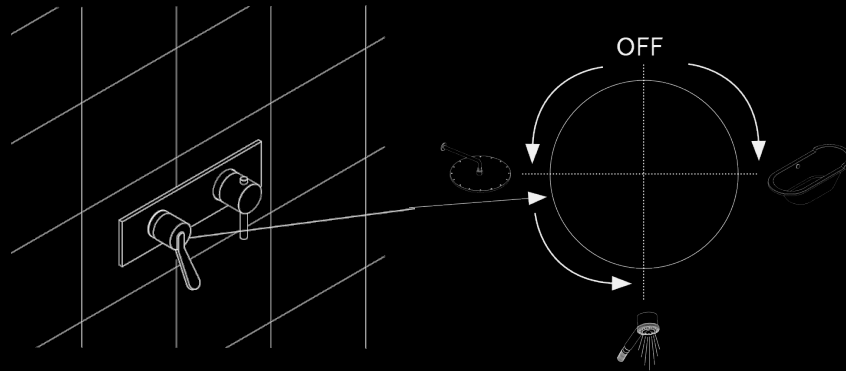
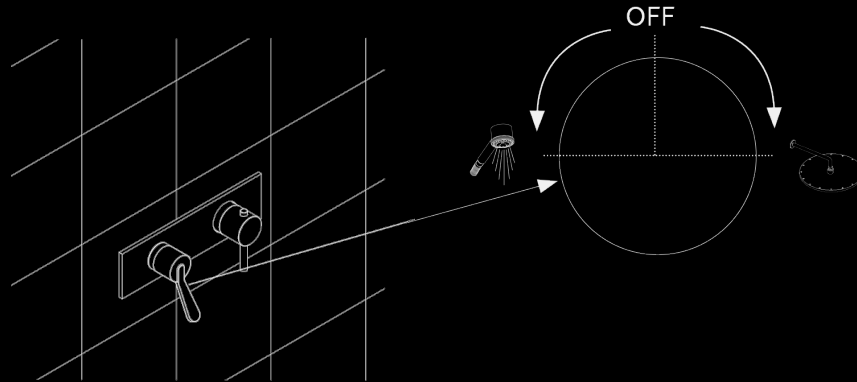



## Fez 2: gruppi vasca / Fez 2: bathtub units



.EFEZ028+.IFEZ028

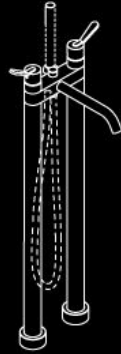

.EFEZ026+.IFEZ026



.MET885

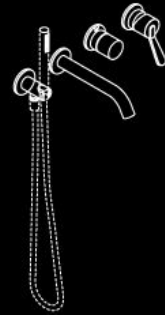

.EFEZ027+.IFEZ027

## Fez 2: composizione / Fez 2: composition

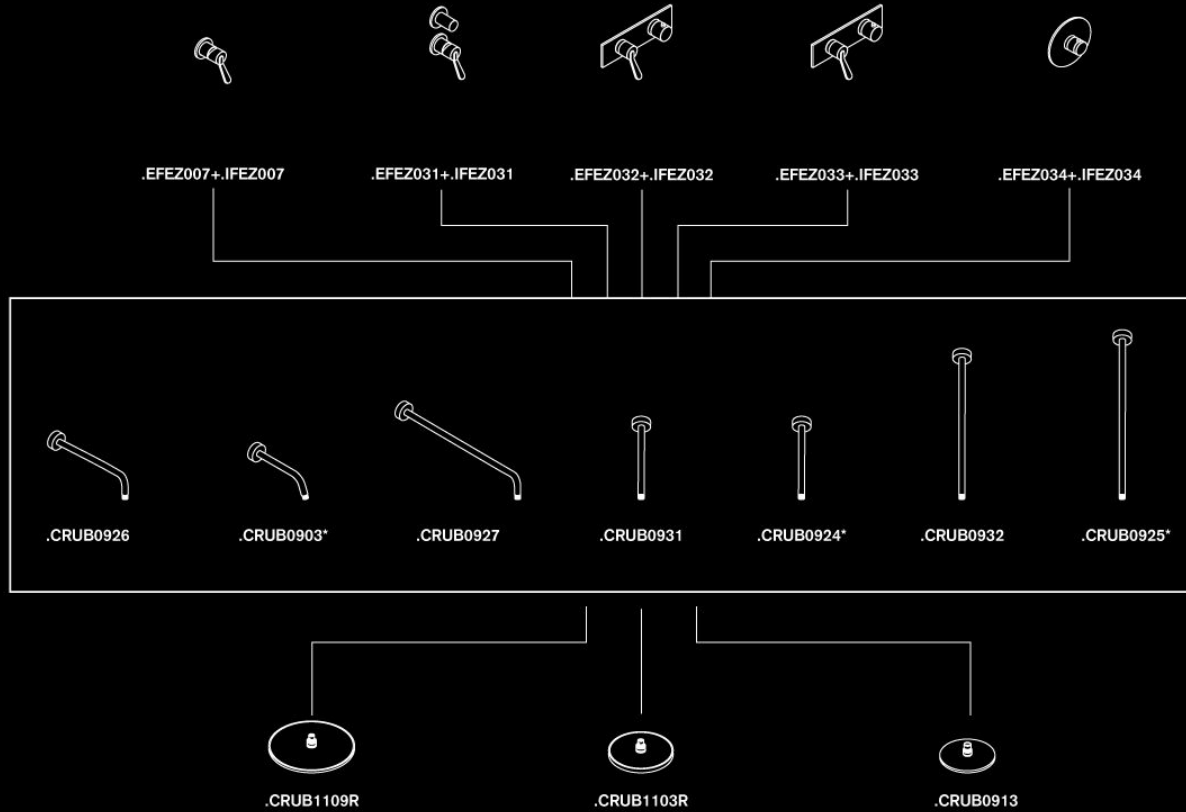

## Fez 2: composizioni / Fez 2: compositions

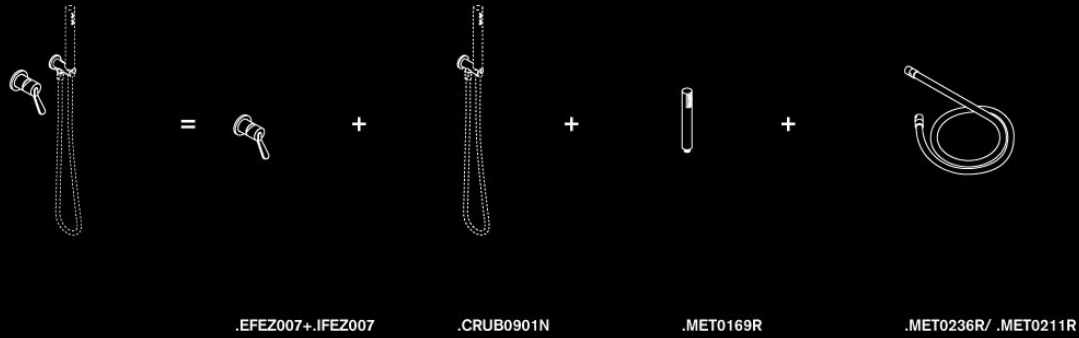

## Fez 2: composizioni / Fez 2: compositions

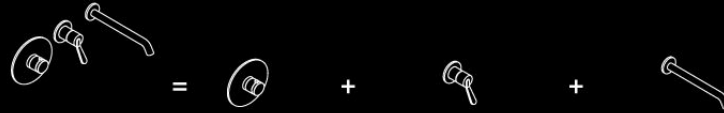

.EFEZ034+.IFEZ034

.EFEZ035+.IFEZ035

.MET887



.EFEZ031+.IFEZ031

.MET887

.CRUB0901N

.MET0169R

.MET0236R/ .MET0211R

## Fez 2: composizioni / Fez 2: compositions

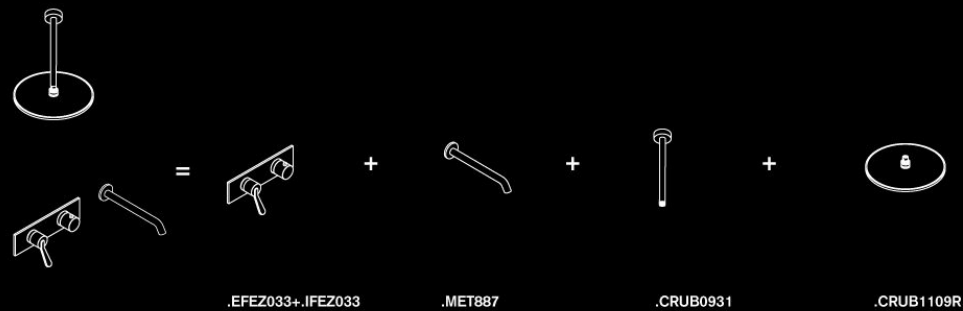
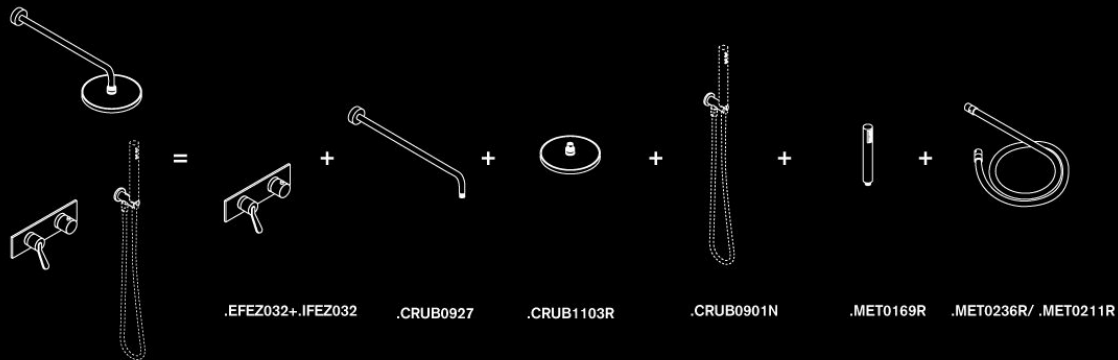

## Fez 2: completare la gamma / Fez 2: complete the range

10

Soffioni e  
integrazioni per  
rubinetteria

Shower heads  
and tapware  
accessories

Kopfbrausen  
und Armaturen-  
Accessoires

Douches de tête et  
intégrations pour  
robinetterie

Alcachofas y  
accesorios para  
grifería

**AL DENTE** - p. 10.3  
design M. Vittori, D. Borin,  
N. Giubertini



**HYDRO** - p. 10.4  
design G. Gianturco, RD Agape



**OPEN AIR** - p. 10.6  
design Benedini Associati

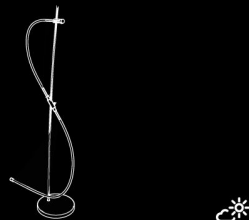

**SOFFIONI  
SHOWER HEADS  
KOPFBRAUSE  
DOUCHES DE TÊTE  
ALCACHOFAS DE DUCHA**  
p. 10.8



Soffioni e  
integrazioni per  
rubinetteria

Shower heads  
and tapware  
accessories

Kopfbrausen  
und Armaturen-  
Accessoires

Douches de tête et  
intégrations pour  
robinetterie

Alcachofas y  
accesorios para  
grifería

**SUPPORTI FLAT D E DX  
FLAT D AND DX SUPPORTS  
FLAT D UND DX WANDHALTERUNGEN  
SUPPORTS FLAT D ET DX  
SOPORTES FLAT D Y DX**  
p. 10.11



**SUPPORTI  
SUPPORTS  
WANDHALTERUNGEN  
SUPPORTS  
SOPORTES**  
p. 10.14



**DOCCETTE E TUBI  
HANDHELD SHOWERS AND HOSES  
HANDBRAUSEN UND SCHLÄUCHE  
DOUCHETTES ET TUBES  
DUCHADORES Y TUBOS**  
p. 10.19



**completare i rubinetti vasca e doccia quando necessario con flessibili, doccette e soffioni contenuti nel capitolo 10 del listino / complete bathtub and shower taps when necessary with hoses, shower hands and shower heads contained in chapter 10 of the price list**

# Limón

## Rubinetteria / taps

agape Limón

design Patricia Urquiola, 2021



## Limón: fresche geometrie / Limón: grafting geometries

L'incontro e l'unione con **la propria sezione circolare**, come nella tradizione dell'innesto agricolo, trasforma le geometrie apparentemente elementari di Limón in qualcosa di completamente diverso. Una nuova e fresca tipologia di rubinetti che comunica la propria struttura e la destinazione d'uso con inusuale **onestà e chiarezza**.

Limón è un altro episodio del percorso di ricerca di Patricia Urquiola nello **smontare e poi ricomporre geometrie** dalle qualità scultoree, iniziato con il lavabo a colonna Lariana seguito dal sistema Rigo.

Meeting and mating with **its own circular section**, just like in the age-old concept of agricultural grafting, has transformed the seemingly elemental geometries of Limón in something completely different. A new and fresh breed of taps that communicate its structure and intended use with unusual **honesty and clarity**.

Limón is an other episode in Patricia Urquiola's research path in **disassembling and then re-composing geometries** with sculptural qualities that started with the Lariana column washbasin followed by the Rigo system.





## Limón: nuove geometrie / Limón: new geometries

### Movimenti convenzionali / Conventional movements

Il miscelatore monoforo per piano Limón funziona nello stesso modo del nuovo Memory Mix: verso l'alto e basso per il controllo del flusso e sinistra/ destra per la regolazione della temperatura.

Le diverse posizioni che segnano le temperature possono **dare vita a configurazioni interessanti** e quasi scultoree dell'intero oggetto.

.....  
The Limón single-hole countertop mixer works in the same way as the new Memory Mix: up and down for flow control and left/right for temperature control.

The different positions that mark the temperatures **can result in interesting**, almost sculptural configurations of the entire object.

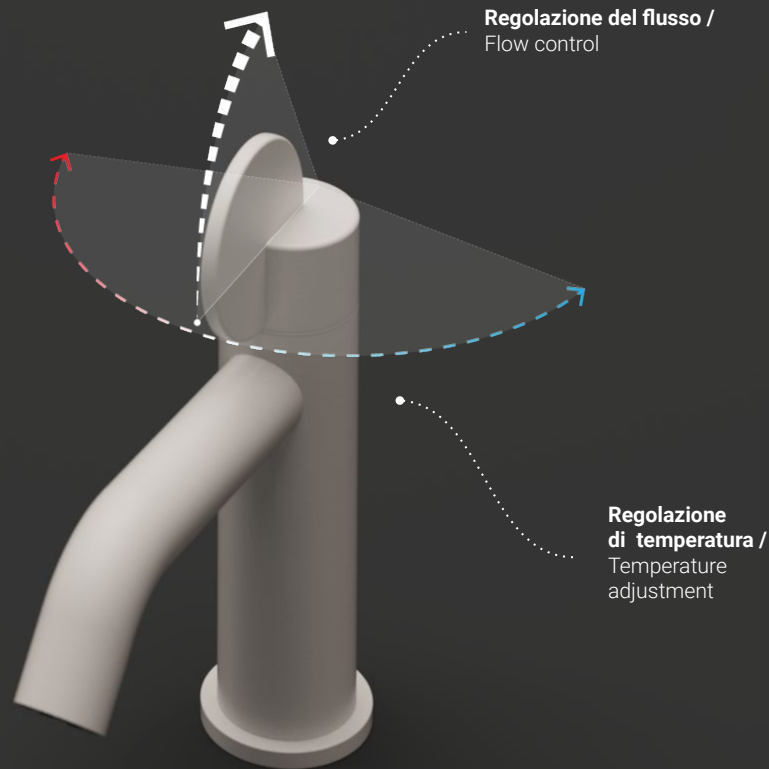

**Tradizionale a doppio comando e controllo termostatico /**

**Traditional, double lever and thermostatic controls**

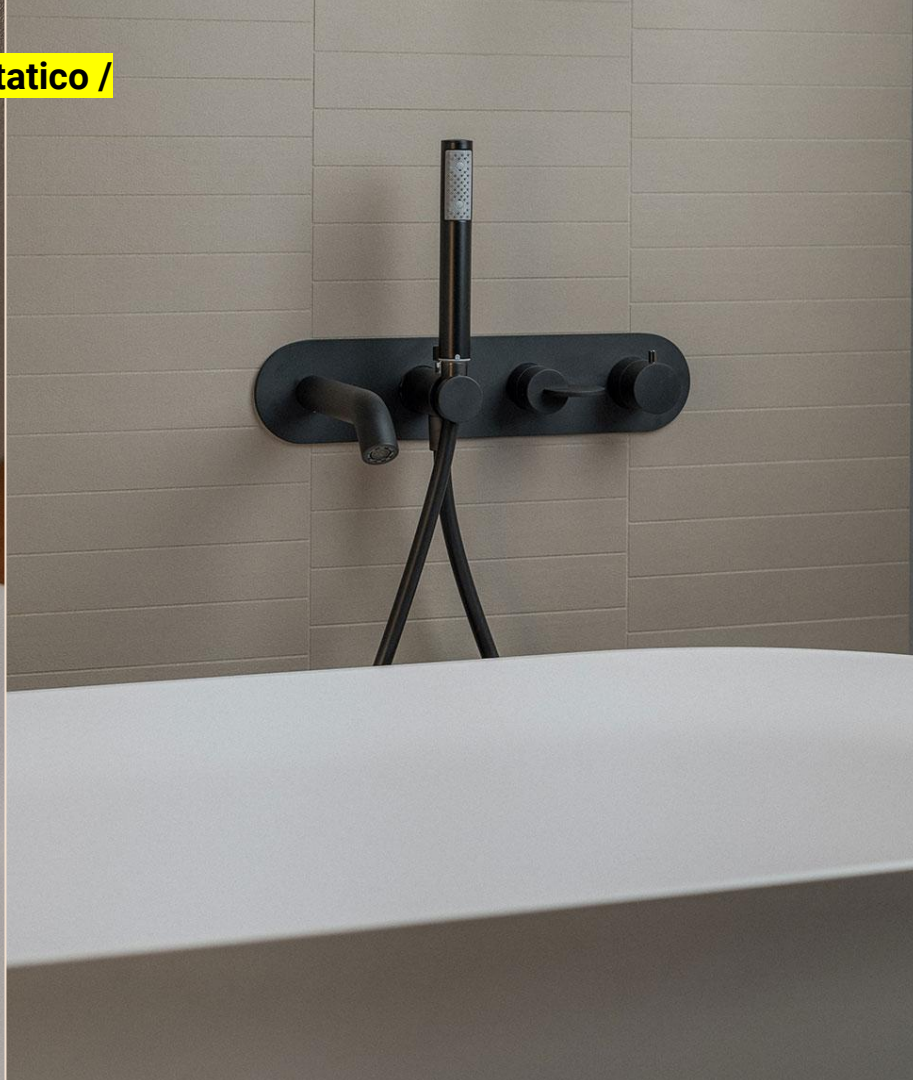
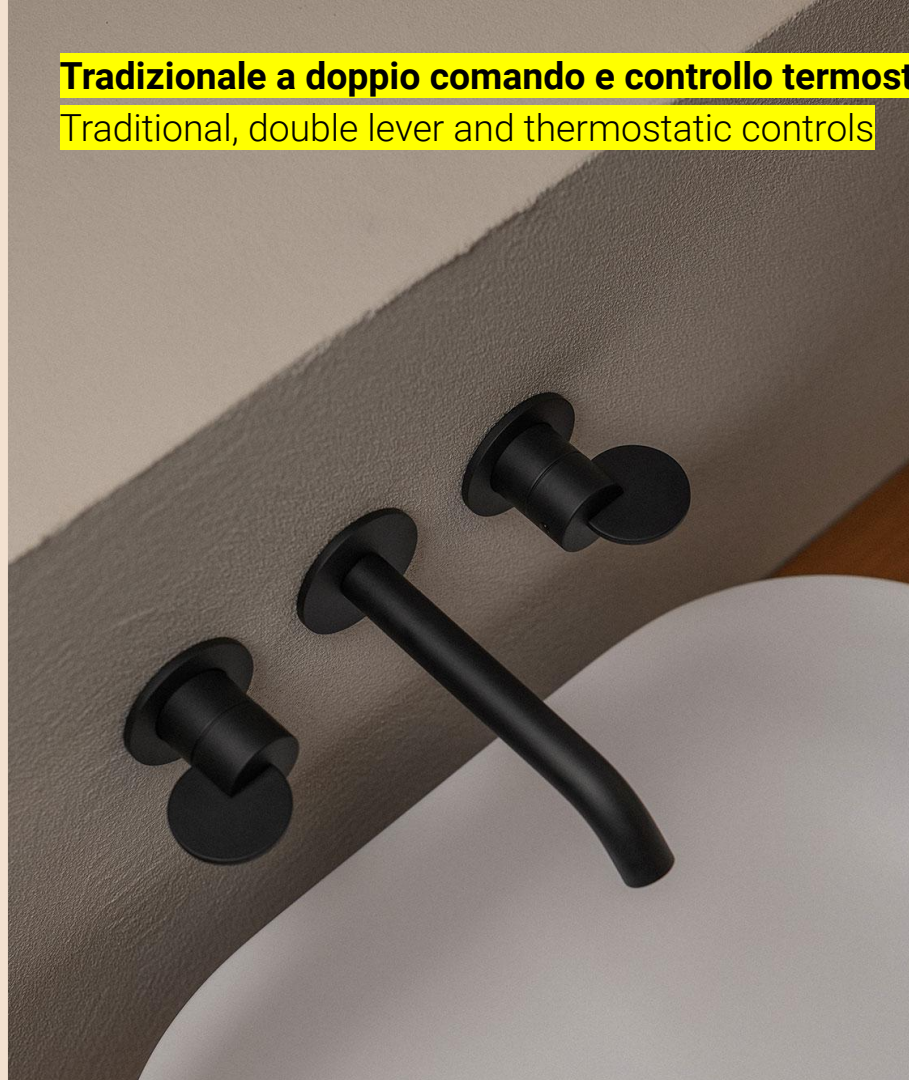

# Limón: una gran varietà di finiture / Limón: a great variety of finish

## STANDARD

## SU RICHIESTA / UPON REQUEST [MIN 10 UNITÀ']

## SU RICHIESTA / UPON REQUEST [MIN 5 UNITÀ']



**Cromo /**  
chrome  
[S]



**Ottone spazzolato /**  
**naturale /**  
Natural Brushed  
Brass  
[NR]



**Ottone brunito /**  
**spazzolato /**  
Burnished  
Brass  
[BR]



**Verniciato nero /**  
**RAL 9005 /**  
Black coated  
RAL 9005  
[E]



**Verniciato bianco /**  
**RAL 9003 /**  
White coated  
RAL 9003



**Ottone naturale /**  
**lucido /**  
Natural polished  
brass



**PVD**  
Copper



**PVD**  
Gun Metal



**Nichel Spazzolato /**  
Brushed Nickel

# Limón per lavabo e bidet / Limón for washbasin and bidet

**Gli elementi permettono di soddisfare ogni esigenza funzionale nel bagno: lavabo e bidet.**

The elements allow to cover every functional need in the bathroom: Washbasins and Bidet.

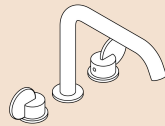

**Gruppo per lavabo a tre fori con doppio comando /**  
Washbasin tap designed to fit three holes with double control

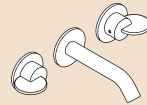

**Gruppo a incasso per lavabo a doppio comando /**  
Built-in washbasin tap with double control

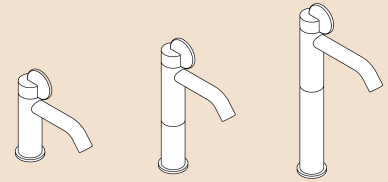

**Miscelatore per lavabo monoforo /**  
single hole mixer tap for washbasin



**Miscelatore per lavabo monoforo da terra /**  
Floor mounted washbasin single hole lever



**Bocca di erogazione per lavabo da terra /**  
Floor mounted washbasin spout



**Miscelatore ad incasso per lavabo /**  
Built-in mixer tap for washbasin

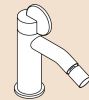

**Miscelatore per bidet monoforo /**  
Single hole mixer tap for bidet

## Limón per vasca / Limón for bathtub



**Miscelatore ad incasso per vasca /**  
Built-in bathtub mixer

---

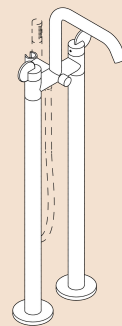

**Gruppo per vasca a pavimento con  
doppio comando e deviatore /**  
Floor mounted bathtub taps set with  
double control and diverter

---



**Bocca per vasca a pavimento /**  
Floor mounted bathtub spout

---

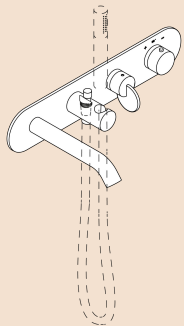

**Gruppo termostatico ad incasso per vasca con deviatore e supporto per doccia /**  
Recessed thermostatic bathtub taps set with diverter and hand-held shower support

---

## Limón per doccia / Limón for shower

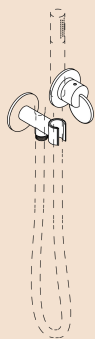

**Monocomando a parete con supporto per doccia /**  
Built-in mixer tap with hand-held shower support

---

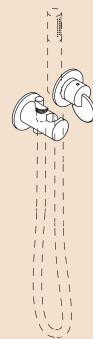

**Monocomando a parete con deviatore e supporto per doccia /**  
Built-in mixer tap with diverter and hand-held shower support

---



**Miscelatore monocomando /**  
Built-in mixer tap

---

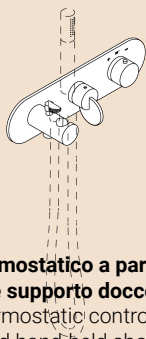

**Gruppo termostatico a parete con deviatore e supporto doccia /**  
Built-in thermostatic control with diverter and hand-held shower support

---



**Comando termostatico a due uscite /**  
Built-in thermostatic control with two outputs

---

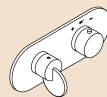

**Comando termostatico a tre uscite /**  
Built-in thermostatic control with three outputs

---



**Rubinetto d'arresto /**  
Built-in thermostatic control

---

# Memory

## Rubinetteria / taps



**Memory: migliorie estetiche / Memory: aesthetic improvements**



**La nuova versione non presenta cambiamenti estetici al classico design della maniglia a croce /**

**The new version has no aesthetic changes to the classic cross handle design**



## Memory: migliorie tecniche / Memory: technical improvements

### Nuovi incassi / New built-in

#### Completamente riprogettate nella funzionalità /

Completely redesigned in functionality

#### Rivestite da un involucro in materiale plastico che protegge il rubinetto garantendone una tenuta ermetica /

Covered by a plastic casing that protects  
the tap ensuring an airtight seal

#### Protezioni indispensabili anche per la certificabilità del prodotto /

Protections indispensable also for the  
certification of the product

#### Piastra a parete solidale al corpo rubinetto con elementi per la regolazione fine /

Wall plate integral with the tap body  
with elements for fine adjustment



## Memory: comando termostatico / Memory: thermostatic control



.EMEM350+.IMEM350



.EMEM351+.IMEM351



.EMEM352+.IMEM352



.EMEM353+.IMEM353

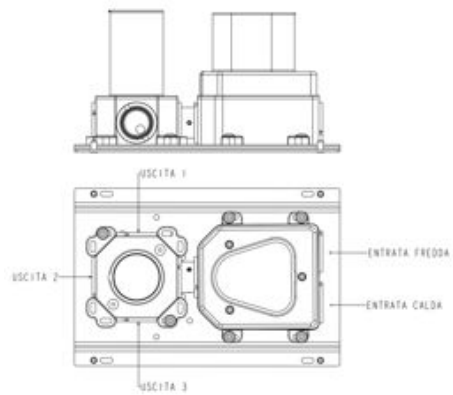

## Memory: miglieorie tecniche / Memory: technical improvements

Nuovi incassi / New built-in

**Corpi ad incasso per piantane vasca e lavabo inizialmente ricavati da lavorazione meccanica da barra di ottone, ora realizzati in monoblocchi a tenuta idraulica protetti da un involucro di materiale plastico che salvaguarda il pavimento da eventuali perdite e che ne permette la certificabilità in molti paesi.**

Built-in bodies for tub and sink pedestals initially obtained from mechanical processing from a brass bar, now made of watertight monoblocs protected by a plastic casing that protects the floor from possible leaks and which allows it to be certified in many countries.



# Memory: piantane / Memory: floor mounted

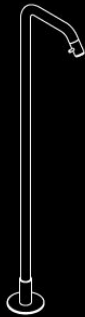

.EMEM323+.IMEM327



.EMEM327+.IMEM327

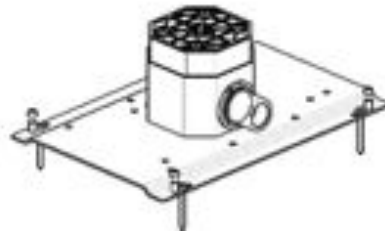

## Memory: miglieorie tecniche / Memory: technical improvements

### Nuovi incassi / New built-in

**Anche in questo caso, i corpi ad incasso sono stati riprogettati. Inizialmente realizzati da fusioni di ottone unite meccanicamente tra loro con rischio di perdite e disallineamento, ora realizzate da monoblocchi a tenuta idraulica, protetti da involucri di materiale plastico che salvaguardano le pareti da eventuali perdite.**

Built-in bodies for tub and sink pedestals initially obtained from mechanical processing from a brass bar, now made of watertight monoblocs protected by a plastic casing that protects the floor from possible leaks and which allows it to be certified in many countries.

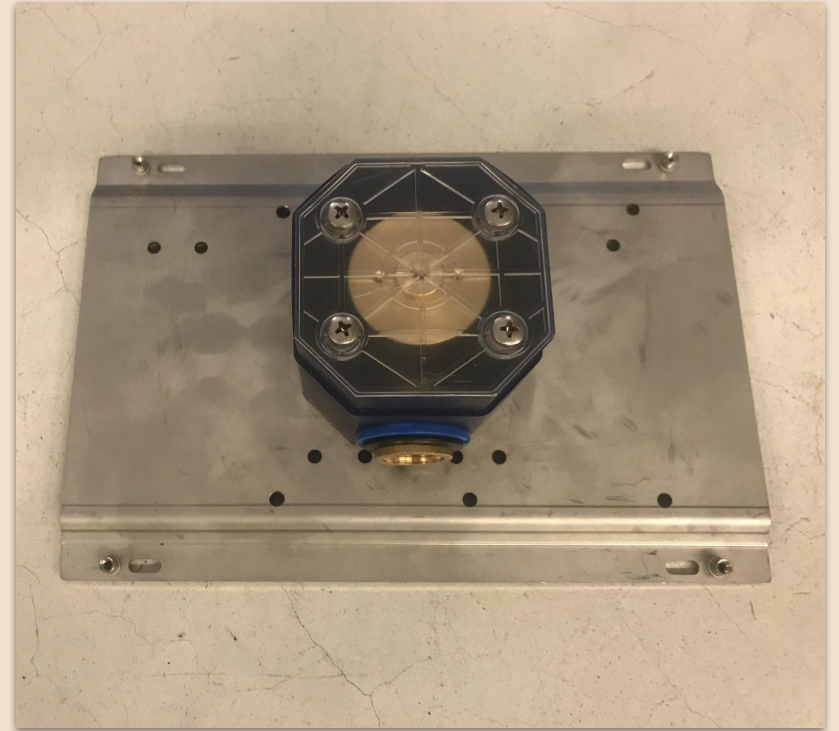

## Memory: migliorie tecniche / Memory: technical improvements

**Staffa per fissare l'incasso alla sottostruttura delle pareti in cartongesso e/o sistemi a secco.**

Bracket for installation ideal for plasterboard and dry construction systems.

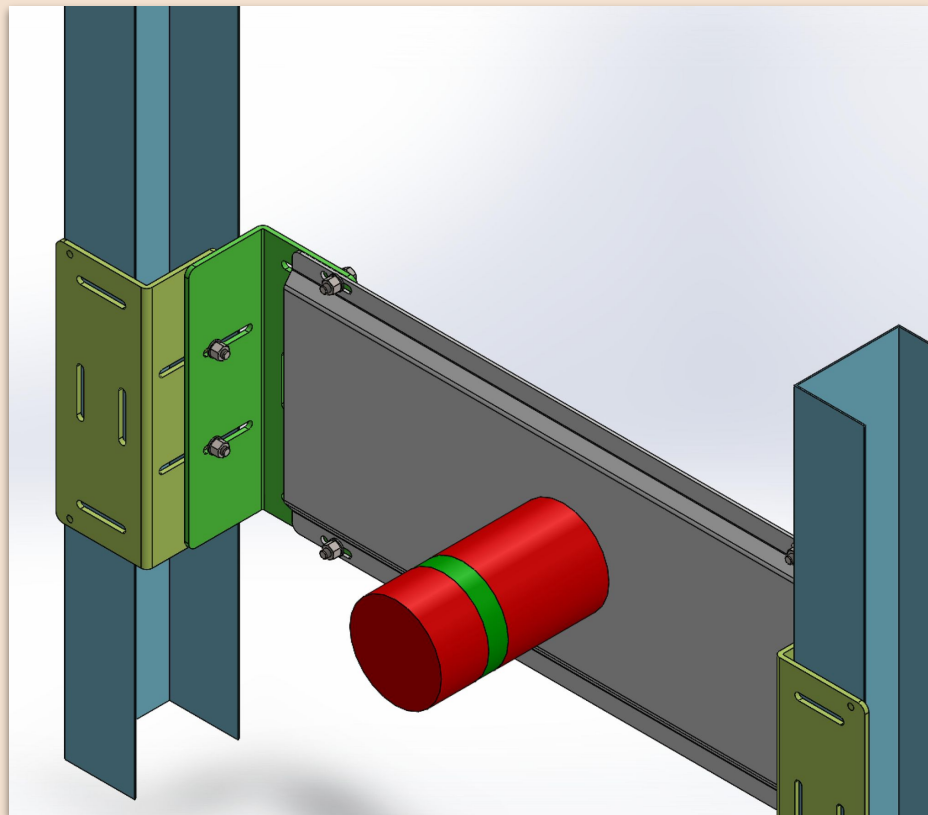

## Memory: finiture standard / Memory: standard finishes



**ottone naturale spazzolato /**  
natural brushed brass



**brunito spazzolato /**  
brushed burnished



**nero / black**



**cromo / chrome**

**Memory: finiture a richiesta** / Memory: finishes upon request



**bianco opaco /**  
matte white



**PVD rame /**  
copper PVD

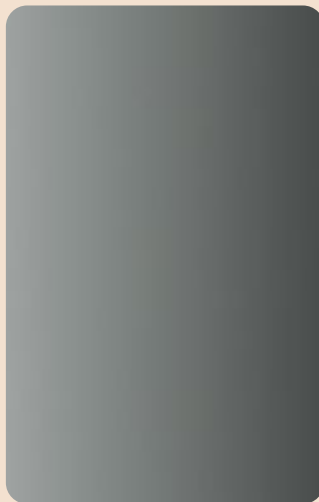

**gun metal**



**ottone spazzolato /**  
brushed brass waxed



**ottone lucido /**  
polished brass



## Memory: finiture a richiesta / Memory: finishes upon request

### **Finiture a richiesta:**

- bianco opaco (RAL9003)
  - ottone naturale lucido
  - altre finiture personalizzate su base ottone naturale
- Lotto minimo 10 pezzi per finitura.  
Maggiorazione 10% sul costo della finitura nero opaco. Tempo di produzione 6 settimane dalla data dell'ordine.

### **Finiture a richiesta:**

- rame PVD\*
  - gun metal PVD\*
  - nichel spazzolato
- Lotto minimo 5 pezzi per finitura.  
Maggiorazione 50% sul costo della finitura cromo. Tempo di produzione 10/12 settimane dalla data dell'ordine.

(\* Physical Vapor Deposition)

### **Finishes upon request:**

- matte white (RAL9003)
  - natural polished brass
  - other custom finishes on natural brass base
- Minimum lot of 10 pieces per finish. 10% surcharge on cost of matte black finish. Production time 6 weeks from order date.

### **Finishes upon request:**

- copper PVD\*
  - gun metal PVD\*
  - brushed nickel
- Minimum lot of 5 pieces per finish. 50% markup on the price of chrome finish. Production time 10/12 weeks from order date.

(\* Physical Vapor Deposition)

# Memory: abaco / Memory: abacus

9

## MEMORY

### Rubinetti

gruppi lavabo



AMEM311

### Taps

washbasin taps



AMEM312

### Armaturen

Waschbeckenarmaturen



AMEM313

### Robinetterie

robinetterie pour lavabos



.EMEM323+.IMEM327

### Griferia

griferia lavabo



ARUB1092



AMEM315



ALIX271



.EMEM321+.IMEM320



.EMEM322+.IMEM320

gruppi bidet



.EMEM331+.IMEM331

bidet taps



.EMEM332+.IMEM331

Bidetarmaturen



.EMEM333+.IMEM333

robinetterie pour bidets



.EMEM344+.IMEM333

griferia bidet



AMEM316

gruppi vasca



.EMEM317+.IMEM317

bathtub tap sets

Badewannenarmaturen

robinetterie pour baignoires

griferia bañeras



EMEM324+.IMEM324



EMEM342+.IMEM342

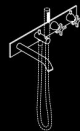

EMEM343+.IMEM343



EMEM327+.IMEM327

## MEMORY

### Rubinetti

gruppi vasca

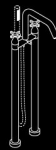

.EMEM325+.IMEM325

gruppi vasca o doccia

### Taps

bathtub tap sets



AMEM326

bathtub or shower tap sets

### Armaturen

Badewannenarmaturen

Badewannen- oder  
Duscharmaturen

### Robinetterie

robinetterie pour baignoires

robinetterie pour baignoires ou  
douches

### Griferia

griferia bañeras

griferia bañeras o duchas



.EMEM330+.IMEM330



.EMEM330+.IMEM340



.EMEM350+.IMEM350



.EMEM351+.IMEM351



.EMEM352+.IMEM352



.EMEM353+.IMEM353



.EMEM335+.IMEM331

accessori



.EMEM336+.IMEM336

accessories



.EMEM341+.IMEM341

accessories



.ERUB1073+.IRUB1073S

accessoires



ARUB1074

accessorios



ARUB0968N

9.68

agape

2023/01

agape 9.67

2023/01

**Memory**

**lavabo /  
washbasin**

**bidet**

**vasca e doccia /  
bathtub and shower**

**vasca /  
bathtub**

**progressivo /  
progressive**

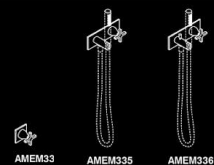
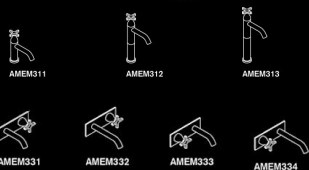

**caldo - freddo /  
hot - cold**

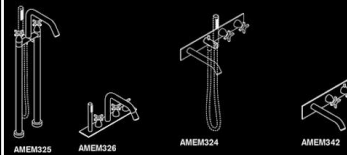

**termostatico /  
thermostatic**

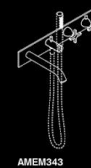
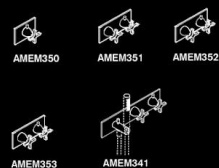

**portata /  
load control**



**altro /  
other**

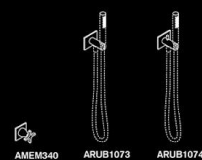

# Memory: comando progressivo / Memory: gradual flow control

## lavabo / washbasin



AEMEM311



AEMEM312



AEMEM313



.EMEM331+.IMEM331



.EMEM332+.IMEM331



.EMEM333+.IMEM333



.EMEM334+.IMEM333

## bidet



AEMEM316

## vasca e doccia / bathtub and shower



.EMEM330+.IMEM330



.EMEM330+.IMEM340



.EMEM350+.IMEM350



.EMEM351+.IMEM351



.EMEM352+.IMEM352



.EMEM353+.IMEM353



.EMEM335+.IMEM331



.EMEM336+.IMEM336

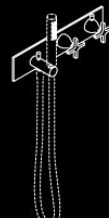

.EMEM341+.IMEM341



.ERUB1073+.IRUB1073S



ARUB1074

**Memory: controllo progressivo** / Memory: progressive control  
**apertura maniglia 180° in senso orario** / 180° clockwise handle opening

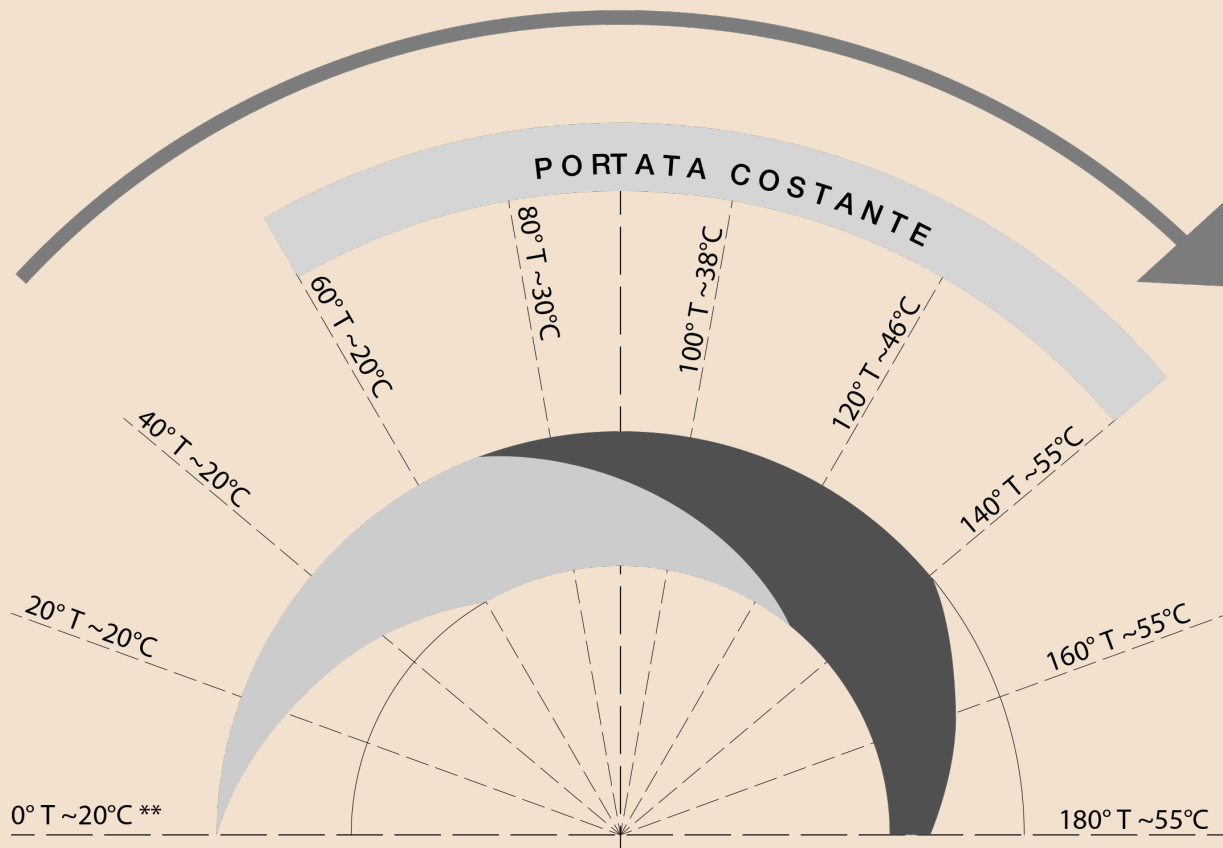

**Memory: nuovo idrobited** / Memory: new Hydrobidet



.EMEM317+.IMEM317

**Memory: nuovo idrobidet** / Memory: new Hydrobidet



**finitura brunito spazzolato** / brushed burnished finish

**Memory: nuovo idrobited** / Memory: new Hydrobidet





## Memory: comando caldo-freddo / Memory: hot-cold control



AMEM315



.EMEM321+.IMEM320



.EMEM322 + .IMEM320

**lavabo** / washbasin

---

**vasca e doccia** / bathtub and shower

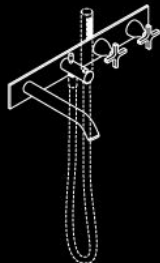

.EMEM324+.IMEM324

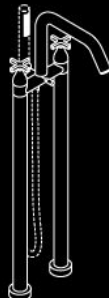

.EMEM325+.IMEM325



AMEM326

## Memory: comando termostatico / Memory: thermostatic control



.EMEM342+.IMEM342



.EMEM343+.IMEM343



.EMEM351+.IMEM351

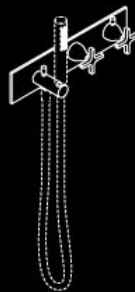

.EMEM341+.IMEM341

vasca e doccia / bathtub and shower

---

## Memory: comando termostatico / Memory: thermostatic control



.EMEM350+.IMEM350

**termostatico senza comando a portata** / thermostatic valve without flow regulation

---

**termostatico a 1, 2 o 3 vie** / thermostatic with 1, 2 o 3 outputs



.EMEM351+.IMEM351



.EMEM352+.IMEM352



.EMEM353+.IMEM353

## Memory: termostatico + deviatore (2 o 3 vie) /

Memory: thermostatic + flow deviator (2 or 3 outputs)

ruotando la manopola regolare il flusso selezionare la periferica desiderata /

turn the handle to adjust the flow and select the desired device

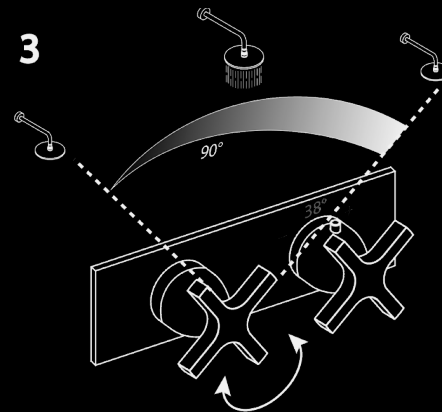
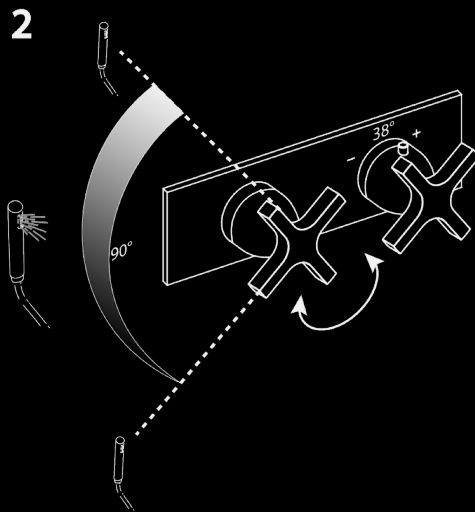
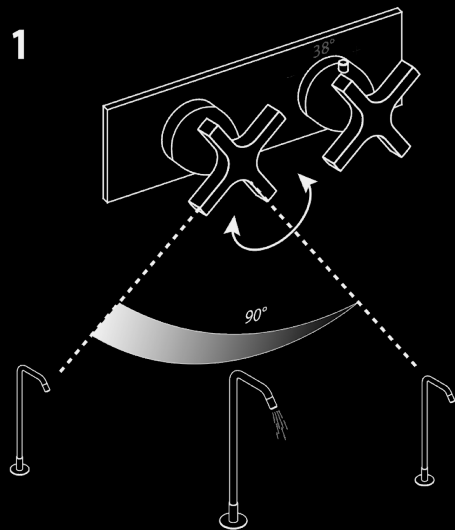

da posizione 1 a posizione 3 ruotare in senso orario /

from position 1 to position 3 turn counterclockwise direction

## Memory: comandi a portata / Memory: flow controls

rubinetti freestanding / taps freestanding

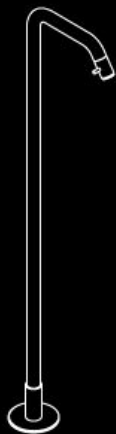

.EMEM323+.IMEM327

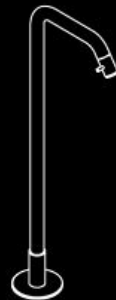

.EMEM327+.IMEM327

+



.EMEM350+.IMEM350

da abbinare al comando termostatico /  
to be combined with the thermostatic control

## Memory: comandi a portata / Memory: flow controls



.EMEM330+.IMEM330



.EMEM330+.IMEM340

rubinetto di arresto / stop tap

---

# Memory: istruzioni ad incasso ed esterno / Memory: Recessed and external instructions

**agape** ISTRUZIONI DI MONTAGGIO  
ASSEMBLY INSTRUCTIONS

<b>EMEM342</b>		<b>2/7</b>
DATA	VERSIONE	

**CONTENUTO DELLA CONFEZIONE  
PACKAGE CONTENTS**

**STRUMENTI  
TOOLS**

**INCASSO  
EMEM342**

**EMEM342**

MIN 81.5 (3.2)

MAX 14 (0.55)

INVESTIMENTO FINITO  
FINISHED WALL SURFACE

**agape** ISTRUZIONI DI MONTAGGIO  
ASSEMBLY INSTRUCTIONS

<b>EMEM331-EMEM332</b>		<b>2/6</b>
DATA	VERSIONE	

**CONTENUTO DELLA CONFEZIONE  
PACKAGE CONTENTS**

**STRUMENTI  
TOOLS**

**ESTERNO  
EMEM331  
EMEM332**

**PREDISPOSIZIONE  
TAP PREDISPOSITION**

**ALIBINETTO INSTALLATO  
TAP MOUNTED**

**INCASSO  
EMEM331**

**ESTERNO  
EMEM331  
EMEM332**

# Memory Mix

## Rubinetteria / taps

Memory Mix



design Benedini Associati, 2021





## Memory Mix: una nuova maniglia / Memory mix: a new handle

### Un nuovo scenario d'uso / a new usage scenario

La nuova leva Memory Mix è pensata per essere utilizzata con i **tradizionali miscelatori a leva singola e doppia**.

Il rubinetto progressivo sarà ancora disponibile con le maniglie a croce.

The new Memory Mix series is meant to be used with **conventional single and double lever mixers**.

The gradual flow control mixer is still available with the cross shaped handles in the Memory series.

**Memory**  
monoforo progressivo /  
Memory gradual  
flow control mixer

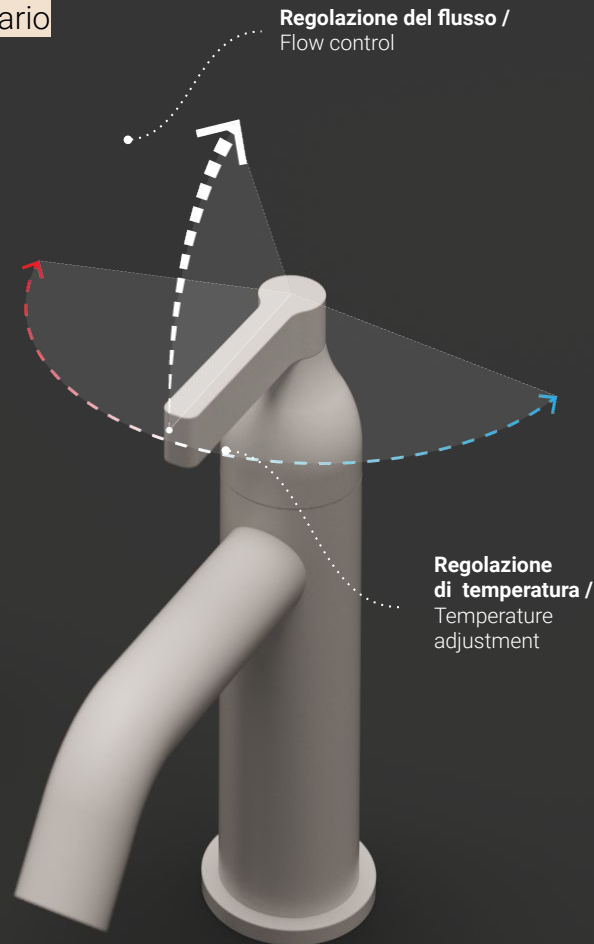
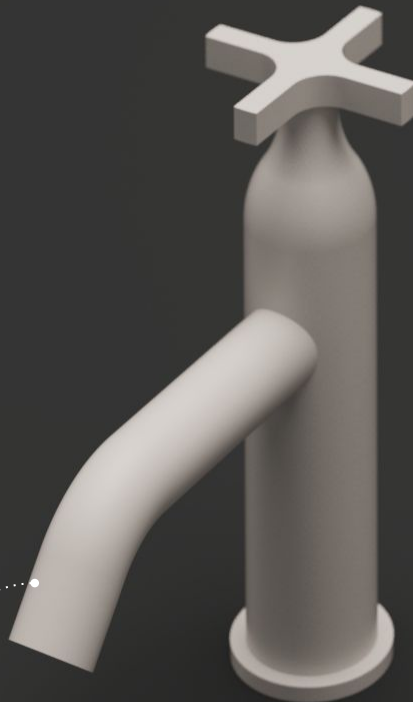

## Memory Mix: una nuova maniglia / Memory mix: a new handle

Un nuovo scenario d'uso / a new usage scenario

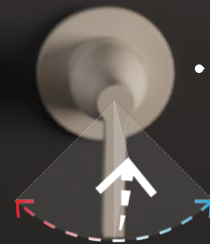
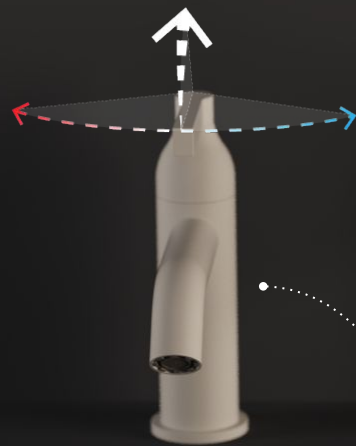

Leva singola per  
montaggio a muro /  
Single lever for wall  
mounting

Leva singola per  
montaggio su piano /  
Single lever for  
plan mounting

**Disponibile sia per installazione su piano che a parete /**  
**Available for both plan and wall installation.**

## Memory Mix: family feeling / Memory mix: family feeling

### Design derivato / Derivative design

La nuova leva **prende la sua forma** direttamente **dalla iconica maniglia a croce** della serie Memory.

La nuova leva singola è lunga il doppio di un braccio dell'impugnatura Memory "convenzionale". La sua larghezza è stata regolata e leggermente allargata per essere **ergonomicamente coerente** con il nuovo modello di utilizzo.

The new lever **derives its shape** directly **from the iconic cross-shaped** handle of the Memory series.

The new single lever is twice as long as one arm of the "conventional" Memory handle. Its width had been adjusted and slightly widened to be **ergonomically coherent** with the new usage pattern.

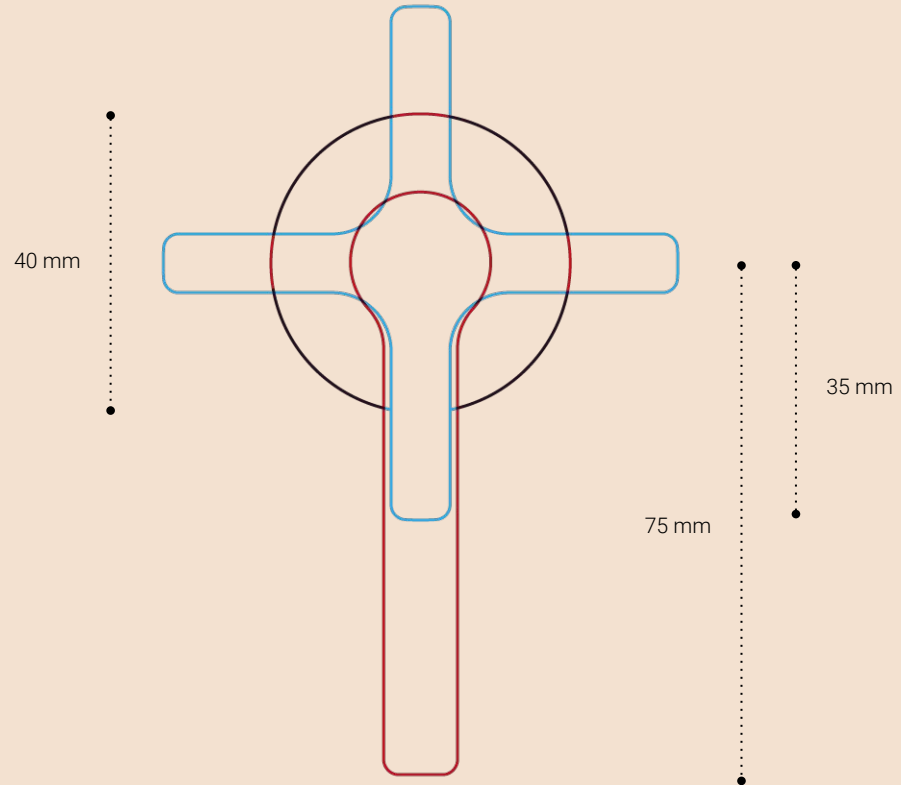

**Memory Mix: family feeling** / Memory mix: family feeling

**Design derivato** / Derivative design



# Memory Mix per lavabo e bidet / Memory Mix for washbasin and bidet

**Il nuovo elemento permette di rispondere ad ogni necessità nell'ambiente bagno: Lavabi e Bidet.**

The elements allow to cover every functional need in the bathroom: Washbasins and Bidet.

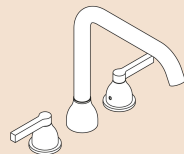

**Gruppo per lavabo a tre fori con doppio comando /**  
Washbasin tap designed to fit three holes with double control

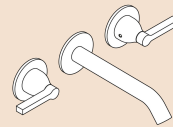

**Gruppo a incasso per lavabo a doppio comando /**  
Built-in washbasin tap with double control

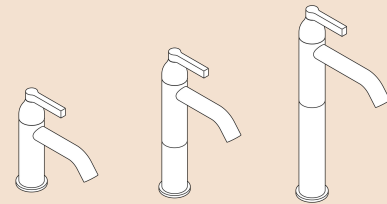

**Miscelatore per lavabo monoforo /**  
single hole mixer tap for washbasin



**Miscelatore per lavabo monoforo da terra /**  
Floor mounted washbasin single hole lever



**Bocca di erogazione per lavabo da terra /**  
Floor mounted washbasin spout



**Miscelatore ad incasso per lavabo /**  
Built-in mixer tap for washbasin

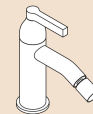

**Miscelatore per bidet monoforo /**  
Single hole mixer tap for bidet

## Memory Mix per vasca / Memory Mix for bathtub



**Miscelatore ad incasso per vasca /**  
Built-in bathtub mixer

---

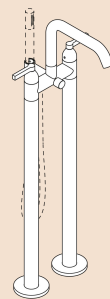

**Gruppo per vasca a pavimento con  
doppio comando e deviatore /**  
Floor mounted bathtub taps set with  
double control and diverter

---

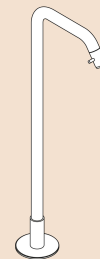

**Bocca per vasca a pavimento /**  
Floor mounted bathtub spout

---

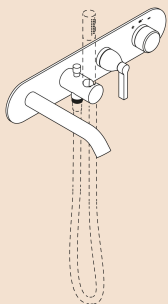

**Gruppo termostatico ad incasso per vasca con deviatore e supporto per doccia /**  
Recessed thermostatic bathtub taps set with diverter and hand-held shower support

---

# Memory Mix per doccia / Memory Mix for shower



**Monocomando a parete con supporto per doccia /**  
Built-in mixer tap with hand-held shower support

---



**Monocomando a parete con deviatore e supporto per doccia /**  
Built-in mixer tap with diverter and hand-held shower support

---



**Miscelatore monocomando /**  
Built-in mixer tap

---

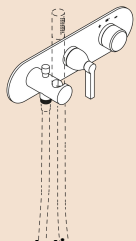

**Gruppo termostatico a parete con deviatore e supporto doccia /**  
Built-in thermostatic control with diverter and hand-held shower support

---

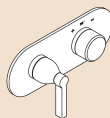

**Comando termostatico a due uscite /**  
Built-in thermostatic control with two outputs

---

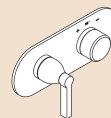

**Comando termostatico a tre uscite /**  
Built-in thermostatic control with three outputs

---



**Rubinetto d'arresto /**  
Built-in thermostatic control

---

# Memory Mix: è disponibile in tutte le finiture della serie Memory /

Memory Mix: is available in all finishes of the Memory series

## STANDARD



**Cromo /**  
chrome  
[S]



**Ottone spazzolato / naturale /**  
Natural Brushed  
Brass  
[NR]



**Ottone brunito / spazzolato /**  
Brushed Burnished  
Brass  
[BR]



**Verniciato nero / RAL 9005 /**  
Black coated  
RAL 9005  
[E]



**Verniciato bianco / RAL 9003 /**  
White coated  
RAL 9003



**Ottone naturale lucido /**  
Natural polished  
brass



**PVD  
Copper**



**PVD  
Gun Metal**



**Nichel Spazzolato /**  
Brushed Nickel

## SU RICHIESTA / UPON REQUEST [MIN 10 UNITÀ']

## SU RICHIESTA / UPON REQUEST [MIN 5 UNITÀ']



# Sen

## Rubinetteria / taps



# Sen: abaco / Sen: abacus

SEN

9

## Rubinetti

gruppi lavabo/bidet



ASEN0910

## Taps

washbasin/bidet taps



ASEN0956

## Armaturen

Waschbecken/Bidetarmaturen



ASEN0957

## Robinetterie

robinetterie pour lavabos/  
bidets



ESEN0962+ CRUB0972

## Griferia

griferia lavabo/bide



ESEN0912HO+ ISEN0912O

## gruppi vasca/doccia



ESEN0911+ CRUB0972

## bath/tub/shower tap sets



ESEN0977+ ISEN0977

## Badewannen-/Duscharmaturen



ESEN0912VO+ ISEN0912O

## robinetterie pour baignoires/ douches



ESEN0942N + ISEN0942

## griferia bañeras/duchas

## gruppi vasca/doccia



ESEN0914O+ ISEN0912O

## bath/tub/shower tap sets



ASEN0973

## Badewannen-/Duscharmaturen



ASEN0975N

## robinetterie pour baignoires/ douches



ESEN0913ON+ ISEN0912O

## griferia bañeras/duchas



ESN0958+ ISEN0958

accessories

accessoires

accessories

accessoires

accessorios



ASEN0968









AKIT680

2023/01

agape 0.143

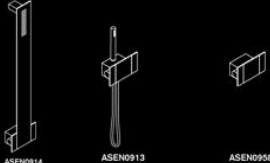
**Sen:**  
abaco  
funzionamento

	lavabo	bidet	vasca/doccia	vasca
miscelatore	 <p>ASEN0910 ASEN0906 ASEN0907 ASEN0902</p>	 <p>ASEN0910</p>		 <p>ASEN0911 ASEN0977</p>
caldo/freddo	 <p>ASEN0912HS</p>		 <p>ASEN0914 ASEN0913 ASEN09580</p>	 <p>ASEN0912VS</p>

Sen: gruppi lavabo / Sen: washbasin units



ASEN0910



ASEN0956



ASEN0957

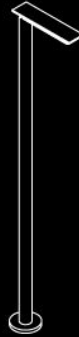

.ESEN0962+.CRUB0972



.ESEN0912HO+.ISEN0912O



**Sen: gruppi vasca e doccia / Sen: bathtub and shower units**



.ESEN0911+.CRUB0972

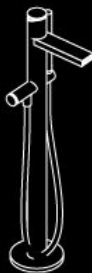

.ESEN0977+.ISEN0977



.ESEN0912VO+.ISEN0912O



.ESEN0942N + .ISEN0942



.ESEN0914O+.ISEN0912O

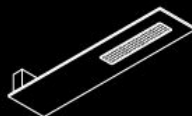

ASEN0973



ASEN0975N



.ESEN0913ON+.ISEN0912O



.ESN0958+.ISEN0958

**Sen: accessori / Sen: accessories**



ASEN0968

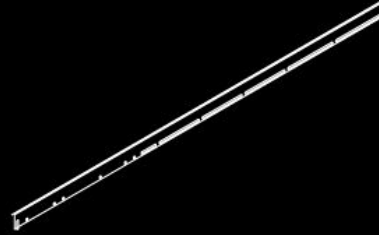

AKIT680

**Sen: composizione doccia / Sen: shower composition**

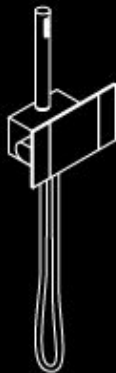

**.ESEN0913ON+.ISEN0912O**

+



**.ESN0958+.ISEN0958**

+

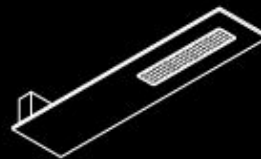

**ASEN0973**

**Sen: composizione doccia / Sen: shower composition**





**Sen: composizione doccia / Sen: shower composition**

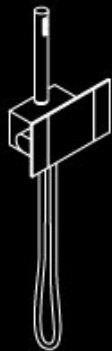

.ESEN0913ON+.ISEN09120

+



.ESN0958+.ISEN0958

+



ASEN0973

+



.ESEN0914O+.ISEN09120

**Sen: composizione doccia / Sen: shower composition**

# Sen: composizione / Sen: composition



ISTRUZIONI DI MONTAGGIO  
ASSEMBLY INSTRUCTIONS

SEN - AKIT680A

COD.  
011230

VERS.  
20180208/2 - SV

2/6

CONTENUTO DELLA CONFEZIONE  
PACKAGE CONTENTS

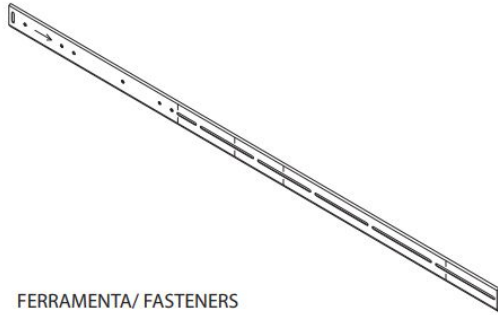

FERRAMENTA/ FASTENERS



STRUMENTI/ TOOLS

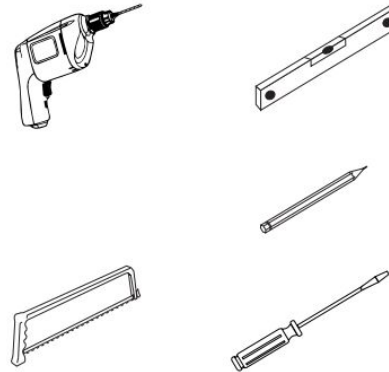

# Sen: composizione / Sen: composition

Es. Composizione con 1 mensola - 2 rubinetti  
Ex. Composition with 1 shelf - 2 taps.

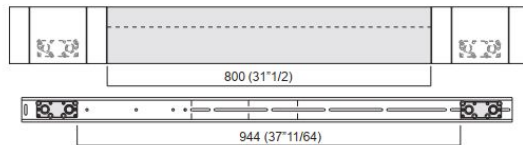
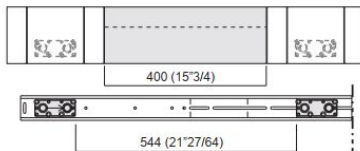
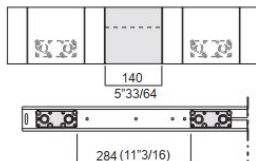

Es. Composizione con 2 rubinetti accostati  
Ex. Composition with 2 adjacent taps

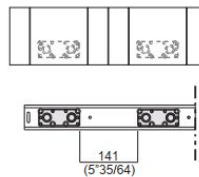

Es. Composizione con 3 rubinetti - 2 mensole  
Ex. Composition with 3 taps - 2 self

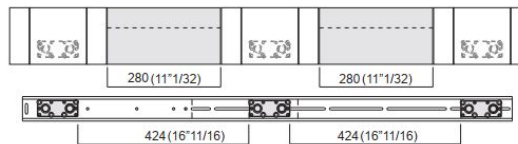

# Square

## Rubinetteria / taps

agape Square

design Benedini Associati, 2015



# Square: abaco / Square: abacus

9

## SQUARE

### Rubinetti

gruppi lavabo



.ERUB1082T+ .IRUB1082T  
ARUB1009T

### Taps

washbasin taps



.ERUB1116+ .IRUB1082T

### Armaturen

Waschbecken Armaturen



ARUB1083

### Robinetterie

robinetterie pour lavabos



ARUB1084

### Griferia

griferia lavabo



ARUB1095



ARUB1006



ARUB1007



ARUB1008



ARUB1081



ARUB1029 - ARUB1041



ARUB1041

gruppi bidet



.ERUB1096+ .IRUB1096

bidet taps

Bidet Armaturen

robinetterie pour bidets

griferia bidé



ARUB1097

gruppi doccia

shower taps

Duscharmaturen

robinetterie pour douches

griferia duchas



.ERUB1113+ .IRUB1113



.ERUB1119+ .IRUB1119



.ERUB1110+ .IRUB1082T



.ERUB1121+ .IRUB1121

## SQUARE

### Rubinetti

gruppi vasca



.ERUB1117+ .IRUB1117  
.ERUB1118+ .IRUB1117

soffioni



.CRUB1160

supporti



.CRUB1163

accessori



ARUB0968N

### Taps

bathtub tap sets



.ERUB1112+ .IRUB1112

shower heads



.CRUB1161

supports



.CRUB1170

accessories



9.162

### Armaturen

Badewannenarmaturen



.ERUB1115+ .IRUB1112

Kopftausen



.CRUB1162

Halteungen



.CRUB1171

accessoires



9.162

### Robinetterie

robinetterie pour baignoires



ARUB0960

douches de tête



.CRUB1120

supports



.CRUB1172

accessoires



9.162

### Griferia

griferia bañeras

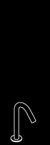

.CRUB1160

alcachofas



repisoporfissas



.CRUB1173

accessorios



9.162

# Square: gruppo lavabo e bidet / Square: washbasin and bidet units



.ERUB1082T+.IRUB1082T  
ARUB1009T



.ERUB1116+.IRUB1082T



ARUB1083



ARUB1084



ARUB1095



ARUB1097



ARUB1006



ARUB1007



ARUB1008



ARUB1081



ARUB1029 - ARUB1041



ARUB1041

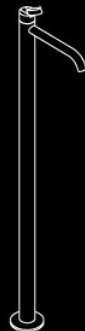

.ERUB1096+.IRUB1096

lavabo / washbasin

bidet

## Square: gruppo vasca e doccia / Square: bathtub and shower units



.ERUB1113+.IRUB1113

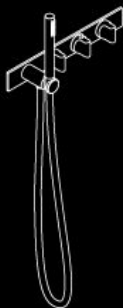

.ERUB1119+.IRUB1119



.ERUB1110+.IRUB1082T



.ERUB1121+.IRUB1121

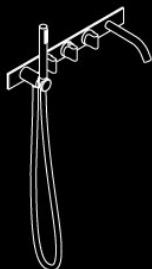

.ERUB1117+.IRUB1117  
.ERUB1118+.IRUB1117

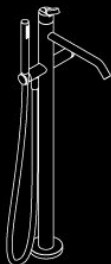

.ERUB1112+.IRUB1112



.ERUB1115+.IRUB1112

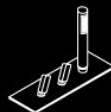

ARUB0960



.CRUB1180



# Square: soffioni e supporti / Square: shower head and supports



.CRUB1160



.CRUB1161



.CRUB1162



.CRUB1120

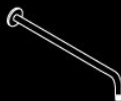

.CRUB1163



.CRUB1170



.CRUB1171



.CRUB1172



.CRUB1173

**Square: soffioni** / Square: shower head



**Square: soffioni / Square: shower head**



**Square: soffioni** / Square: shower head



**finitura lucido** / polished finish  
**finitura lucida nero** / polished black finish

# Square: soffioni e integrazione per rubinetterie /

## Square: shower heads and tap ware accessories

10

Soffioni e  
integrazioni per  
rubinetteria

Shower heads  
and tapware  
accessories

Kopfbrausen  
und Armaturen-  
Accessoires

Douches de tête et  
intégrations pour  
robinetterie

Alcachofas y  
accesorios para  
grifería

Soffioni e  
integrazioni per  
rubinetteria

Shower heads  
and tapware  
accessories

Kopfbrausen  
und Armaturen-  
Accessoires

Douches de tête et  
intégrations pour  
robinetterie

Alcachofas y  
accesorios para  
grifería

**AL DENTE** - p. 10.3  
design M. Vittori, D. Borin,  
N. Gibertini



**SUPPORTI FLAT D E DX**  
FLAT D AND DX SUPPORTS  
FLAT D UND DX WANDHALTERUNGEN  
SUPPORTS FLAT D ET DX  
SOPORTES FLAT D Y DX  
p. 10.11



**HYDRO** - p. 10.4  
design G. Gianturco, RD Agape



**SUPPORTI**  
SUPPORTS  
WANDHALTERUNGEN  
SUPPORTS  
SOPORTES  
p. 10.14



**OPEN AIR** - p. 10.6  
design Benedini Associati

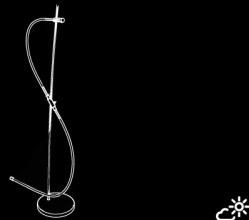

**DOCCETTE E TUBI**  
HANDHELD SHOWERS AND HOSES  
HANDBRAUSEN UND SCHLÄUCHE  
DOUCHETTES ET TUBES  
DUCHADORES Y TUBOS  
p. 10.19



**SOFFIONI**  
SHOWER HEADS  
KOPFBRAUSE  
DOUCHES DE TÊTE  
ALCACHOFAS DE DUCHA  
p. 10.8



**Square: soffioni e integrazione per rubinetterie /**

Square: shower heads and tap ware accessories



**Square: soffioni e integrazione per rubinetterie /**

Square: shower heads and tap ware accessories



**Square: soffioni e integrazione per rubinetterie /**

Square: shower heads and tap ware accessories





## Certificazioni rubinetteria / Tapware certifications



	USA / CAN	Germany	Australia
Sen	UPC	DVGW	WATERMARK
Fez	CSA	—	—
Memory	—	—	WATERMARK

**Certificazioni rubinetterie**  
Rubinetteria Sen

**Certificazione USA:** settembre / ottobre 2020

**Certificazione Germania:** ottobre / novembre 2020

**Certificazioni rubinetterie**  
Rubinetteria Fez e Memory

**Fez 2**

**Certificazione USA:** febbraio 2020

**Memory**

**Certificazione Australia:** aprile 2020

**Certificazione Germania:** ottobre / novembre 2020

**Grazie. Domande? /**  
thank you. questions?

