



ACADEMY

I Sistemi: Quattro diversi programmi modulari per la zona lavabo per celebrare i vostri rituali quotidiani.

The Systems: Four different modular programs for the washbasin area to celebrate your daily rituals.

Systems / Sistemi

The basin area is one of the most complex areas of the bathroom from a functional point of view. Our five systems, each in its own way, satisfy every functional and aesthetic need in well-organized compositions and with a very high degree of customization. Moving on the architectural scale and sharing its language, our systems integrate perfectly into the space that hosts them to celebrate your daily rituals.

L'area lavabo è una delle zone più complesse del bagno dal punto di vista funzionale. I nostri quattro sistemi, ognuno a modo suo, soddisfano ogni esigenza funzionale ed estetica in composizioni ben organizzate e con un altissimo grado di personalizzazione. Muovendosi sulla scala architettonica e condividendone il linguaggio, i nostri sistemi si integrano perfettamente nello spazio che li ospita per celebrare i vostri rituali quotidiani.



Sistemi / Systems

- A. Evo 21
- B. Lato
- C. Flat XL
- D. Rigo

Sistemi, panoramica / systems overview

Evo 21

design Benedini Associati



Lato

design Benedini Associati



Flat XL

design Benedini Associati



Rigo

design Patricia Urquiola



Tipologia compositiva / Tipologia compositiva

Lunghezza composizione minima / Lunghezza composizione minima

Lunghezza composizione massima / Lunghezza composizione massima

Piano / Piano

Altezza contenitori / Altezza contenitori

Larghezza contenitori / Larghezza contenitori

Profondità contenitori / Profondità contenitori

Fanchi / Fianchi

Struttura per piani / Struttura per piani

Posizione lavabo / Posizione lavabo

Alzate / Alzate

Vassoi / Vassoi

a blocco / a blocco

cm 80

cm 240

obbligatorio / obbligatorio

cm 30, 40, 70

cm 40, 60, 80, 100, 120

cm 50

obbligatori / obbligatori

-

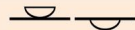

-

-

a blocco e libera / a blocco e libera

cm 80

cm 200

opzionale (EII) / opzionale (EII)

cm 20, 40

cm 40, 60, 80, 100, 120

cm 50

-

-



-

-

a blocco e libera / a blocco e libera

cm 80

cm 240

obbligatorio / obbligatorio

cm 20, 40

cm 40, 60, 80, 100, 120

cm 44, 50

-

-



-

-

libera / libera

cm 120

cm 120

opzionale / opzionale

-

-

-

-



-

opzionali / opzionali

A. Sistema Evo 21 / Evo 21 system



Che cos'è Evo 21 / what is Evo 21

Evo 21 è il nuovo sistema modulare entry level per la composizione di pareti monoblocco con contenitori chiusi dalla grande capacità di contenimento.

Evo 21 is the new entry level modular system for monobloc wall composition with closed storage units with a large containment capacity.

COMPOSIZIONI / COMPOSITION

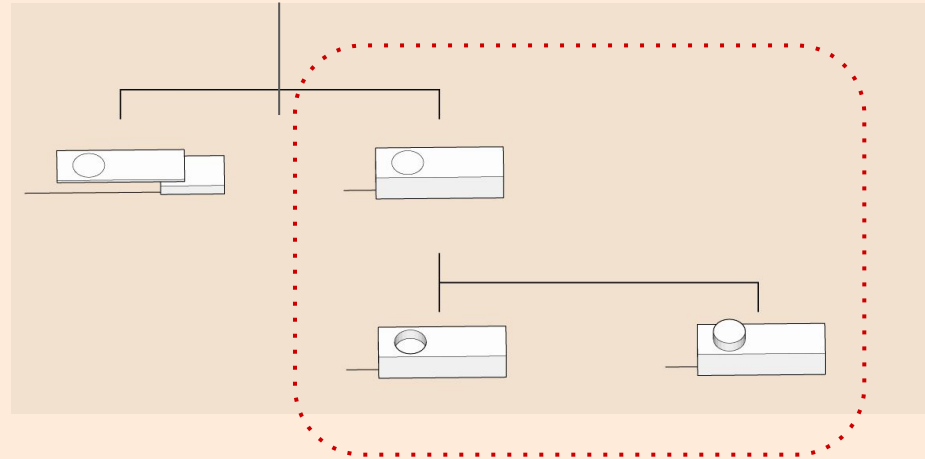

**COMPOSIZIONI CON CONTENITORI INDIPENDENTI /
COMPOSITION WITH INDEPENDENT STORAGE UNITS**

**COMPOSIZIONI CON CONTENITORI INTEGRATI /
COMPOSITION WITH INTEGRATED STORAGE UNITS**

FLAT XL
LATO
RIGO

EVO 21

Componenti / components

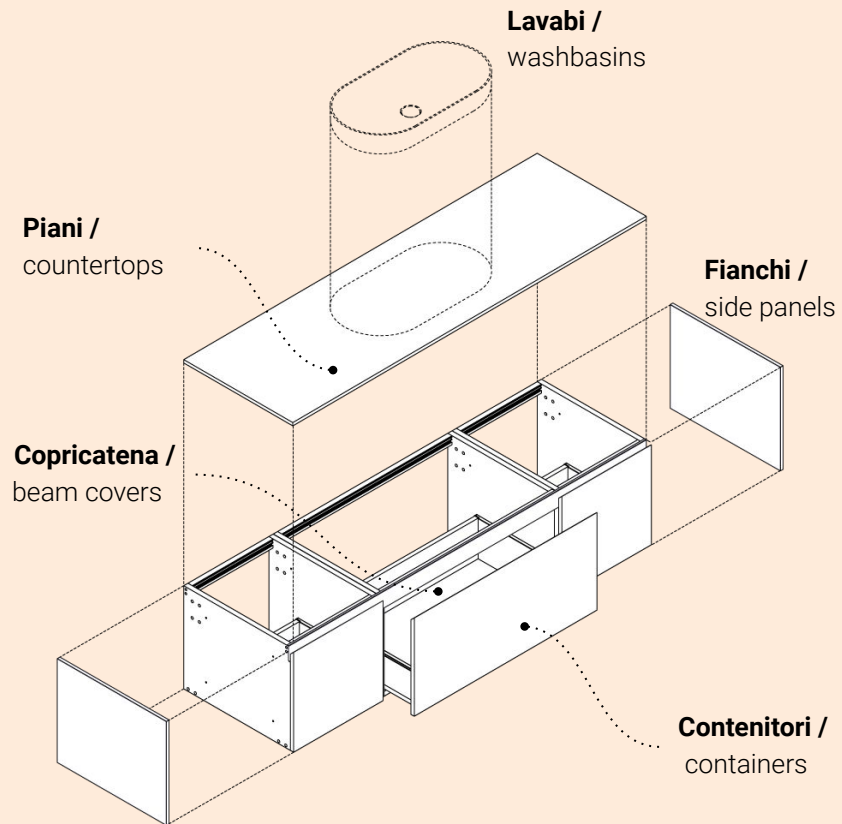

Piani / countertops

Evo 21

Agape Systems - 39

Evo 21

Countertops - 40 cm and 50 cm deep / Piani - profondità 40 cm e 50 cm

AE21PA_ d / p 50 cm
AE21PF_ d / p 40 cm

Top thickness /
Spessore piano

cm 1,2

L cm 80 - 240

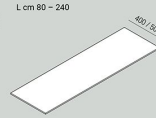

Solid surface top for over-countertop
washbasins / Piano in solid surface per lavabi
da appoggio

SS



AE21PB_ d / p 50 cm
AE21PG_ d / p 40 cm

Top thickness /
Spessore piano

cm 1,2

L cm 80 - 240

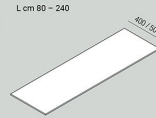

Top in phenolic birch plywood with pre-
composite wood covering for over-countertop
washbasins / Piano in multistrato di betulla
fenolica con rivestimento in legno precomposto
per lavabi da appoggio



AE21PC_ d / p 50 cm
AE21PH_ d / p 40 cm

Top thickness /
Spessore piano

cm 6

L cm 80 - 240

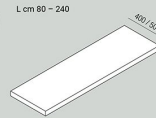

Top in phenolic birch plywood with pre-
composite wood covering for over-countertop
washbasins / Piano in multistrato di betulla
fenolica con rivestimento in legno precomposto
per lavabi da appoggio



AE21PD_ d / p 50 cm
AE21PL_ d / p 40 cm

Top thickness /
Spessore piano

cm 2

L cm 80 - 240

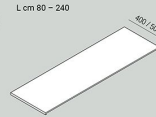

Top in marble for over-countertop washbasins
and built-in Undici Inox / Piano in marmo per
lavabi da appoggio e lavabo sottopiano Undici
Inox



agape

Piani / countertops

42 - Agape Systems

Evo 21

Evo 21

Countertops with integrated washbasins / Piani con lavabi integrati



agape

Evo 21

Agape Systems - 43

Evo 21

Countertops with integrated washbasin / Piani con lavabo integrato

Raso

Top thickness / Spessore piano

cm 1,2

SS

AE21PA185L_SS

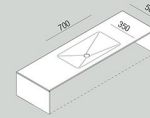

L cm 80 - 240

AE21PA285L_SS

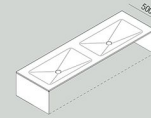

L cm 160 - 240

Nivis

Top thickness / Spessore piano

cm 1,2

SS

AE21PA163L_SS

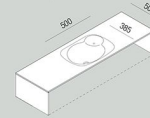

L cm 80 - 240

AE21PA263L_SS

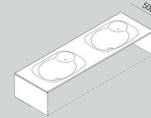

L cm 160 - 240

Ottocento 001

Top thickness / Spessore piano

cm 1,2

SS

AE21PA1M01_SS

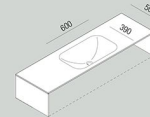

L cm 80 - 240

AE21PA2M01_SS

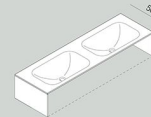

L cm 160 - 240

Ottocento 002

Top thickness / Spessore piano

cm 1,2

SS

AE21PA1M02_SS

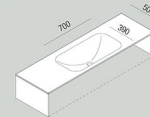

L cm 100 - 240

AE21PA2M02_SS

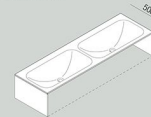

L cm 200 - 240

agape

Piani / countertops

44 - Agape Systems

Evo 21

Evo 21

Countertops with integrated washbasins / Piani con lavabi integrati

Undici Tondo

Top thickness / Spessore piano

cm 1.2



AE21PA181L_SS

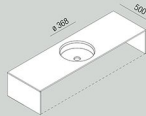

L cm 80 - 240

AE21PA281L_SS

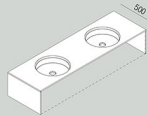

L cm 91,2 - 240

Undici Rettangolare

Top thickness / Spessore piano

cm 1.2



AE21PA184L_SS

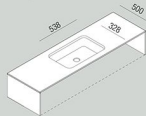

L cm 80 - 240

AE21PA284L_SS

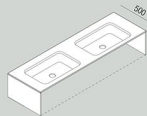

L cm 128,2 - 240

Undici Ovale

Top thickness / Spessore piano

cm 1.2



AE21PA186L_SS

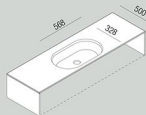

L cm 80 - 240

AE21PA286L_SS

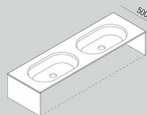

L cm 131,2 - 240

Undici Inox

Top thickness / Spessore piano

cm 2



AE21PD1_

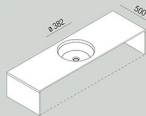

L cm 80 - 240

AE21PD2_

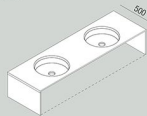

L cm 127,4 - 240

agape

Evo 21

Agape Systems - 45

Evo 21

Countertops with integrated washbasin / Piani con lavabo integrato



agape

Piani / countertops

46 - Agape Systems

Evo 21

Evo 21

Litorale: integrated washbasin / Litorale: lavabo integrato



agape

Evo 21

Agape Systems - 47

Evo 21

Litorale: integrated washbasin / Litorale: lavabo integrato

The Litorale channel washbasin, in its countertop version, was designed to be the ideal companion to the Evo 21 system. Its dimensions perfectly integrate Litorale into the precise architectural geometries of the system. 50 cm deep, the height of the washbasin is only 6 cm while the range of lengths goes from 80 to 240 cm (nominal) for the version with one waste and from 160 to 240 cm for the version with two drains.

The material used in its construction, solid surface in 12 mm sheets, contributes to build the perfect interface between the two products. In the basin it is also possible to place trays of different sizes (20, 40 and 60 cm) in two different materials (white solid surface or solid iroko wood).

Following the general rules of the Evo 21 system, even when Litorale is used, the basin / top must cover the entire length of the composition and the two sides.

Il lavabo a canale Litorale, nella sua versione in appoggio, è stato concepito per essere l'abbinamento ideale al sistema Evo 21. Le sue dimensioni integrano perfettamente Litorale nelle precise geometrie architettoniche del sistema. Profondo 50 cm, l'altezza del lavabo è di soli 6 cm mentre la gamma delle lunghezze va da 80 a 240 cm (nominal) per la versione con uno scarico e da 160 a 240 cm per la versione con due scarichi.

Anche il materiale utilizzato, il solid surface in lastre da 12 mm, contribuisce a costruire l'interfaccia perfetta tra i due prodotti. Sul catino è inoltre possibile inserire i piani di appoggio di diverse dimensioni (20, 40 e 60 cm) in due diversi materiali (solid surface bianco o legno iroko massello).

Seguendo le regole generali del sistema Evo 21, anche quando si utilizza Litorale, il catino/piano deve coprire l'intera lunghezza della composizione e i due fianchi.

Top thickness / Spessore piano

cm 6



AE21PE1LTR_

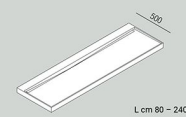

AE21PE2LTR_

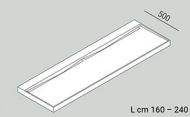

Solid surface top with integrated washbasin with single layer (single drainage) / Piano in solid surface con lavabo integrato a falda unica (scarico singolo)

Solid surface top with integrated washbasin with single layer (double drainage) / Piano in solid surface con lavabo integrato a falda unica (doppio scarico)

Tray support top in solid surface or iroko, freely positionable on the surface of the Litorale top/washbasin / Piano portaoggetti in solid surface o in iroko posizionabile liberamente sul bacino del piano/lavabo Litorale

ACOM2039_



ACOM2039_



ACOM2039_



agape

Contenitori / storage units

Evo 21 containers come in three different heights: 30, 40 and 70 cm. The length of the containers is modular, starting from 40 cm, every 20 cm, up to 120 cm. Their depth is always 50 cm.

Every type of container can be made to measure between 40 and 120 cm.

The introduction of 30 cm containers allow for more articulated modularity, higher containment capacity and more nicely proportioned compositions.

Evo 21 containers are closed only on three faces: the bottom and the two sides. The top and the back are always open, therefore every container needs to be covered by a countertop. The front is always fully closed by the drawers' front panels.

I contenitori Evo 21 sono disponibili in tre diverse altezze: 30, 40 e 70 cm. La lunghezza dei contenitori è modulare, a partire da 40 cm, ogni 20 cm, fino a 120 cm. La loro profondità è sempre di 50 cm.

Ogni tipo di contenitore può essere realizzato su misura da 40 a 120 cm.

L'introduzione di contenitori da 30 cm consente una modularità più articolata, una maggiore capacità di contenimento e composizioni più piacevolmente proporzionate.

I contenitori Evo 21 sono chiusi solo su tre lati: il fondo e le due facce laterali. Il top e lo schienale sono sempre aperti, quindi ogni contenitore necessita di essere coperto da un piano. Il frontale è sempre completamente chiuso dai frontali dei cassetti.

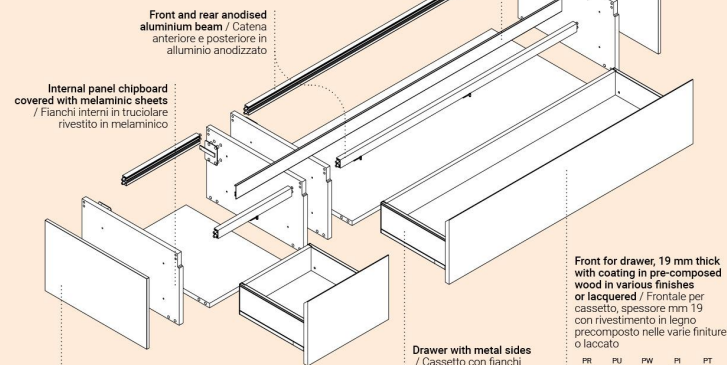

Lateral finishing panels, 12 mm thick in solid surface, in pre-composite wood, lacquered, open-pore lacquered, or in marble / Fianchi di finitura laterali, spessore mm 12 in Solis surface, legno precomposto, laccati, laccati a poro aperto o in marmo



Beam cover in white or dark grey painted aluminium / Rivestimento per catena in alluminio verniciato bianco o grigio scuro



Chipboard covered with melaminic sheets / Truciolare rivestito in melaminico

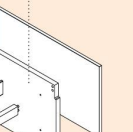

Front for drawer, 19 mm thick with coating in pre-composed wood in various finishes or lacquered / Frontale per cassetto, spessore mm 19 con rivestimento in legno precomposto nelle varie finiture o laccato



Contenitori / storage units

The simplicity of Evo 21 and its compatibility with the rest of the Agape catalogue is ensured by its modularity. The container units are available in lengths of 40, 60, 80, 100 and 120 cm. By placing one or more modules next to each other the length of the overall composition can range from 80 to 240 cm.

Evo 21 introduces a new set of vertical dimensions for its containers that can be 30, 40 or 70 cm tall resulting in compositions with refined proportions and high containment capacity.

La semplicità di Evo 21, e la sua compatibilità con il resto del catalogo Agape deriva anche dalla sua modularità. Gli elementi contenitori sono disponibili in lunghezze da 40, 60, 80, 100 e 120 cm che, con il loro accostamento, permettono di realizzare composizioni di lunghezze complessive che vanno da 80 a 240 cm.

Evo 21 introduce una nuova gamma di altezze per i suoi contenitori che possono essere 30, 40 o 70 cm di altezza e permettono di realizzare composizioni dalle proporzioni raffinate e dall'elevata capacità di contenimento.

L 40 L 60 L 80 L 100 L 120

H 30 cm



H 40 cm



H 70 cm

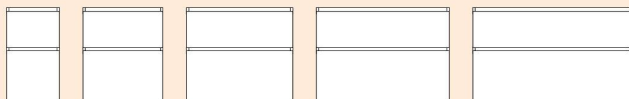

H 30 cm – L 40 / 60 / 80 / 100 / 120

AE21CA_

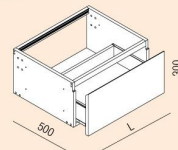

H 30 cm storage unit with one drawer /
Contenitore H cm 30 con un cassetto

AE21CB_

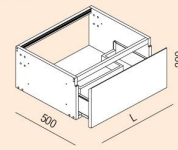

H 30 cm storage unit under basin /
Contenitore H cm 30 sottolavabo

AE21CC_

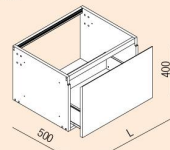

H 40 cm storage unit with one drawer /
Contenitore H cm 40 con un cassetto

H 40 cm – L 40 / 60 / 80 / 100 / 120

AE21CD_

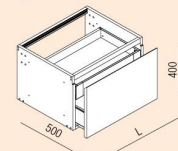

H 40 cm storage unit with one internal drawer /
Contenitore H 40 cm con un cassetto interno

AE21CE_

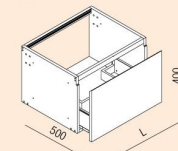

H 40 cm storage unit under basin /
Contenitore H cm 40 sottolavabo

H 70 cm – L 40 / 60 / 80 / 100 / 120

AE21CF_

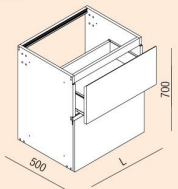

H 70 cm storage unit with two drawers /
Contenitore H cm 70 con due cassetti

AE21CG_

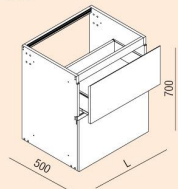

H 70 cm storage unit under basin with two drawers /
Contenitore H cm 70 sottolavabo con due cassetti

Contenitori / storage units

he flexibility of Evo 21 is not limited to its extensive modularity: each container can be made to measure. The system doesn't include compensation elements to ensure a maximum formal cleanliness and the best use of the containment spaces.

Flexibility also means easy installation. Evo 21 adapts with its volume to any installation situation allowing the management of the hydraulic parts directly in the space available behind the drawers. This allows to accommodate the existing position of the drain and have maximum freedom in the placement of taps and washbasins.

Evo 21 is configured as the ideal choice not only for complete projects but also for light renovations that do not involve structural interventions.

La flessibilità di Evo 21 non deriva solo dalla sua estesa modularità: ogni contenitore può essere realizzato su misura. Il sistema non prevede elementi di compensazione, ne deriva una grande pulizia formale e un ottimale sfruttamento degli spazi di contenimento.

Flessibilità vuole anche dire facilità di installazione. Evo 21 si adatta con il suo volume ad ogni situazione impiantistica permettendo la gestione delle parti idrauliche direttamente nello spazio disponibile dietro i cassetti. Diventa così possibile accomodare la posizione esistente dello scarico e avere massima libertà nella collocazione della rubinetteria e dei lavabi.

Evo 21 si configura come la scelta ideale non solo per progetti completi ma anche per ristrutturazioni leggere che non prevedono interventi sulla muratura.



Fianchi / finishing sides

The finishing sides are mandatory on both sides of the composition.

They are available in three heights (30, 40, 70 cm) and a single thickness: 12 mm, available only in pairs.

The sides are not bound to the top but must be the same on both sides of the composition.

I fianchi di finitura sono obbligatori su entrambi i lati della composizione.

Sono disponibili in tre altezze (30, 40 e 70 cm) e un unico spessore: 12 cm, acquistabili a coppia.

I fianchi non sono vincolati alla finitura del piano ma devono essere uguali su entrambi i lati della composizione.

in solid surface / in solid surface



in matt lacquered wood / in legno laccato opaco



in pre-composite wood / in legno precomposto



in open-pore lacquered wood / in legno laccato a poro aperto



in marble / in marmo



AE21F3_

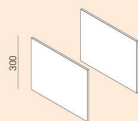

H 30 cm finishing sides / Fianchi di finitura H cm 30

AE21F4_

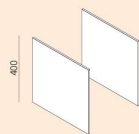

H 40 cm finishing sides / Fianchi di finitura H cm 40

AE21F7_

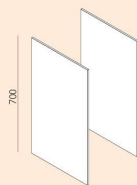

H 70 cm finishing sides / Fianchi di finitura H cm 70

Copricatena / beam cover

The linear development of Evo 21 is further underlined by the groove handles that run through the whole length of the composition. Available in different colors (white and dark grey), the same grooves can have different finishes, further contributing to the overall graphic configuration of the whole.

The beam covers run through the whole length of the composition and cover all the joints between the containers. For the 30 and 40 cm tall containers you will need to specify one cover, while for the 70 cm tall containers, you will have to add two covers.

The length of the beam cover is equal to the sum of the length of the containers therefore it is also equal to the nominal length of the composition itself :

L cover = L containers = L nominal

Lo sviluppo lineare di Evo 21 è accentuato dalle gole che corrono continue per l'intera lunghezza del volume. Le gole possono avere diverse finiture (bianco e grigio scuro) per comporre e raggruppare graficamente i diversi elementi della composizione.

I copricatena percorrono tutta la lunghezza della composizione e coprono tutte le giunzioni tra i contenitori. Per i contenitori alti 30 e 40 cm è necessario specificare un solo copricatena, mentre per i contenitori alti 70 cm ne vanno considerati due.

La lunghezza del copricatena è uguale alla somma della lunghezza dei contenitori per cui è anche uguale alla lunghezza nominale della composizione intera:

L copricatena = L contenitori = L nominale

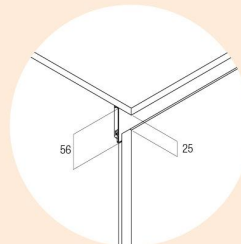

Alzate / splash-back panels

Splash-backs in different materials available 30 or 40 cm high, in wood, marble or Solid Surface, to be placed against the wall and on the back edge of the countertop.

The lengths are nominal and equal to the overall dimensions of the storage units. The actual dimensions of the splash-back have increased by 26 mm as well as for tops.

L=nominal size, real length + 26 mm



AE21A3_

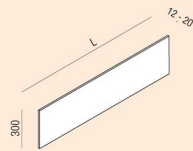

Back-splash 30 cm high, in white solid surface or in phenolic birch plywood with 12 mm thick plywood cladding or 20 mm thick marble / Alzata con altezza 30 cm, in solid surface bianco o in multistrato di betulla fenolica con rivestimento in legno precomposto con spessore 12 mm o in marmo con spessore 20 mm

Alzate in diversi materiali disponibili in due altezze: 30 e 40 cm, in legno, marmo o solid surface, da posizionare a parete e in appoggio sul bordo posteriore del piano.

Le lunghezze sono nominali e sono pari all'ingombro dei contenitori. Le misure reali delle alzate sono aumentate di 26 mm come per i piani.

L=misura nominale, lunghezza reale + 26 mm

AE21A4_

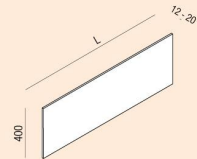

Back-splash 40 cm high, in white solid surface or in phenolic birch plywood with 12 mm thick plywood cladding or 20 mm thick marble / Alzata con altezza 40 cm, in solid surface bianco o in multistrato di betulla fenolica con rivestimento in legno precomposto con spessore 12 mm o in marmo con spessore 20 mm



Finiture / finishes

	Countertops / Piani	Side panels / Fianchi	Front / Frontali	Alzate / Splash back panels
- in solid surface / in solid surface:				
SS. Solid surface / solid surface		<input checked="" type="checkbox"/>	<input checked="" type="checkbox"/>	<input checked="" type="checkbox"/>
- in marble / in marmo:				
MC. white Carrara / bianco Carrara		<input checked="" type="checkbox"/>	<input checked="" type="checkbox"/>	<input checked="" type="checkbox"/>
NM. black Marquina / nero Marquina		<input checked="" type="checkbox"/>	<input checked="" type="checkbox"/>	<input checked="" type="checkbox"/>
GC. grey Carnic / grigio Carnico		<input checked="" type="checkbox"/>	<input checked="" type="checkbox"/>	<input checked="" type="checkbox"/>
VP. green Alpi / verde Alpi		<input checked="" type="checkbox"/>	<input checked="" type="checkbox"/>	<input checked="" type="checkbox"/>
ED. dark Emperador / Emperador dark		<input checked="" type="checkbox"/>	<input checked="" type="checkbox"/>	<input checked="" type="checkbox"/>
PG. Petit granit / Petit granit		<input checked="" type="checkbox"/>	<input checked="" type="checkbox"/>	<input checked="" type="checkbox"/>
- in pre-composite wood / in legno precomposto:				
PR. natural oak / rovere naturale		<input checked="" type="checkbox"/>	<input checked="" type="checkbox"/>	<input checked="" type="checkbox"/>
PU. brown oak / rovere bruno		<input checked="" type="checkbox"/>	<input checked="" type="checkbox"/>	<input checked="" type="checkbox"/>
PW. dark oak / rovere scuro		<input checked="" type="checkbox"/>	<input checked="" type="checkbox"/>	<input checked="" type="checkbox"/>
PI. grey ash oak / rovere cenere		<input checked="" type="checkbox"/>	<input checked="" type="checkbox"/>	<input checked="" type="checkbox"/>
PT. teak / teak		<input checked="" type="checkbox"/>	<input checked="" type="checkbox"/>	<input checked="" type="checkbox"/>
- in matt lacquered wood / in legno laccato opaco:				
B. white / bianco (SIKKENS.ON.00.90)		<input checked="" type="checkbox"/>	<input checked="" type="checkbox"/>	
N. dark grey / grigio scuro (SIKKENS.F2.05.35)		<input checked="" type="checkbox"/>	<input checked="" type="checkbox"/>	
Q. light grey / grigio chiaro (SIKKENS.F2.05.65)		<input checked="" type="checkbox"/>	<input checked="" type="checkbox"/>	
AR. orange / arancio (RAL2008)		<input checked="" type="checkbox"/>	<input checked="" type="checkbox"/>	
- in open-pore lacquered wood / in legno laccato a poro aperto:				
AB. white / bianco (SIKKENS.ON.00.90)		<input checked="" type="checkbox"/>	<input checked="" type="checkbox"/>	
AG. dark grey / grigio scuro (SIKKENS.F2.05.35)		<input checked="" type="checkbox"/>	<input checked="" type="checkbox"/>	
AC. light grey / grigio chiaro (SIKKENS.F2.05.65)		<input checked="" type="checkbox"/>	<input checked="" type="checkbox"/>	
VI. green pine / verde pino (RAL6028)		<input checked="" type="checkbox"/>	<input checked="" type="checkbox"/>	

Scopri Evo 21 / discover Evo 21

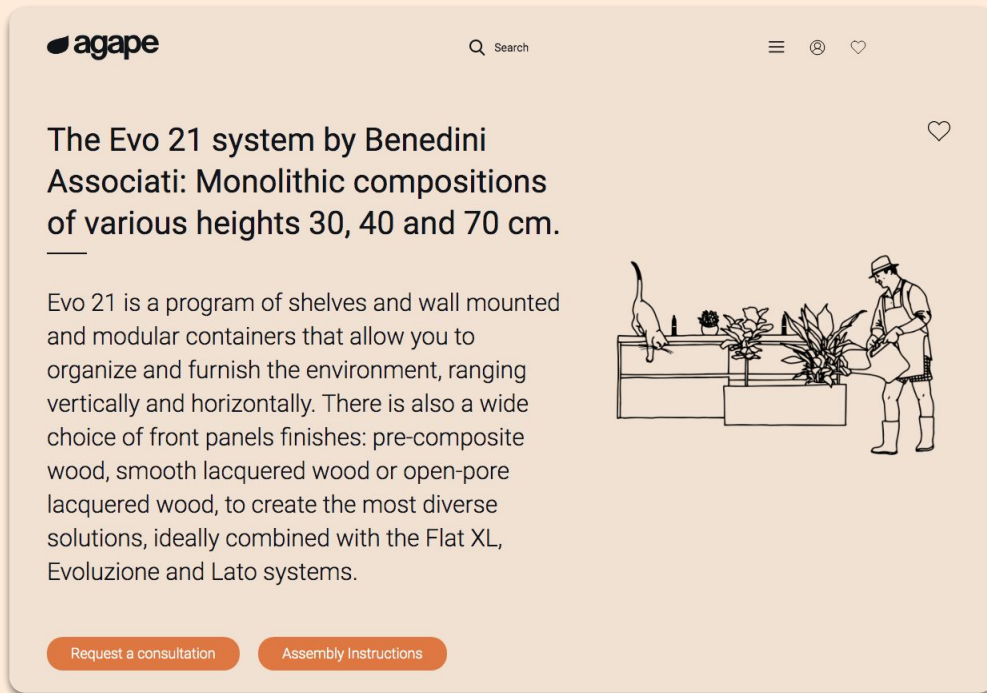

The screenshot shows a website interface for the agape brand. At the top left is the agape logo. To its right is a search bar with a magnifying glass icon and the word "Search". Further right are three icons: a hamburger menu, a person icon, and a heart icon. Below the navigation is the main content area. On the left, there is a title: "The Evo 21 system by Benedini Associati: Monolithic compositions of various heights 30, 40 and 70 cm." followed by a horizontal line. Below the title is a paragraph of text: "Evo 21 is a program of shelves and wall mounted and modular containers that allow you to organize and furnish the environment, ranging vertically and horizontally. There is also a wide choice of front panels finishes: pre-composite wood, smooth lacquered wood or open-pore lacquered wood, to create the most diverse solutions, ideally combined with the Flat XL, Evoluzione and Lato systems." To the right of the text is a line drawing illustration of a man in a hat and overalls standing next to a modular shelving unit. A dog is sitting on the top shelf, and there are plants on the shelves. At the bottom of the content area, there are two orange buttons: "Request a consultation" and "Assembly Instructions".

agape Search

The Evo 21 system by Benedini Associati: Monolithic compositions of various heights 30, 40 and 70 cm.

Evo 21 is a program of shelves and wall mounted and modular containers that allow you to organize and furnish the environment, ranging vertically and horizontally. There is also a wide choice of front panels finishes: pre-composite wood, smooth lacquered wood or open-pore lacquered wood, to create the most diverse solutions, ideally combined with the Flat XL, Evoluzione and Lato systems.

[Request a consultation](#) [Assembly Instructions](#)

Esempi di composizioni / examples of composition



Evo 21 composition.

N. 1/20

L. 80 cm H 40 cm

- Top and sides in White carrara marble
- Front panels in dark oak
- Undici stainless steel washbasin in gun metal
- Memory Mix tap in gun metal
- Nudo mirror
- Dot Line towel holder in dark oak and white Carrara marble
- Lift containers with mirrored doors
- Faro lamp



Evo 21 composition.

N. 2/20

L. 80 cm H 70 cm

- Top and sides in black Marquina marble
- Front panels in brown oak
- Undici Inox filotop washbasin in brushed burnished
- Memory Mix tap in brushed burnished
- Seppia mirror with light
- Pic-nic towel holder in brown oak
- Surf tray
- 125C lamps in black



Evo 21 composition.

N. 3/20

L. 80 cm H 40 cm

- Top, sides, back-splash and front panels in natural oak
- Undici oval washbasin in solid surface
- Sen tap in black anodized aluminium
- Nudo LED and Spai mirrors
- Pic-nic towel holder
- Sen accessories in black anodized aluminium
- Basket in natural oak



Evo 21 composition.

N. 4/20

L. 80 cm H 30 cm

- Top and sides in green Alpi marble
- Front panels in light grey lacquered
- Drop washbasin in Cristalplant® biobased white
- Fez 2 tap floor mounted in chrome
- Memory mirror with light
- Mach 2 accessories in polished stainless steel



Evo 21 composition.

N. 5/20

L. 100 cm H 70 cm

- Top, sides and back-splash in white Carrara marble
- Front panels in brown oak
- Lariana round washbasin in white Carrara marble
- Memory Mix tap in burnished brushed
- Nudo LED e Spai mirrors
- Memory tower holder in burnished brushed



Evo 21 composition.

N. 6/20

L. 120 cm H 30 cm

- Litorale top-washbasin and shelf in white solid surface
- Sides, front panels and back-splash in natural oak
- Memory Mix tap in brushed burnished
- Nudo LED and Spai mirrors
- Lift containers with mirrored door
- Basket in natural oak



Evo 21 composition.

N. 7/20

L. 140 cm H 30 cm

- Top and sides in black Marquina marble
- Front panels in brown oak
- Undici Inox washbasin in brushed burnished
- Memory Mix tap in brushed burnished
- Seppia mirror with light
- Pic-nic towel holder in brown oak
- Memory shelf in brushed burnished and black Marquina marble
- Faro light



Evo 21 composition.

N. 8/20

L. 160 cm H 70 cm

- Top with integrated Raso washbasin and sides in solid surface
- Front panels in natural oak
- Fez 2 tap in black
- Dot Line mirror
- Surf tray
- Dot Line bar in black and shelf with soap dish and glass
- Dot line light



Evo 21 composition.

N. 9/20

L. 180 cm H 30 cm

- Litorale top-washbasin, shelves and sides in solid surface
- Front panels in lacquered open-pore green pine and light grey
- Sen tap in black anodized aluminium
- Eclissi mirror
- Sen hook in black anodized aluminium
- 125C white lamps



Evo 21 composition.

N. 10/20

L. 180 cm H 30 cm

- Top, sides and front panels in brown oak
- Undici Inox washbasin in gun metal
- Memory Mix tap in gun metal
- Vitruvio mirrors
- Memory towel holder in gun metal and black Marquina marble
- Surf tray in black Marquina marble



Evo 21 composition.

N. 11/20

L. 200 cm H 30 cm

- Top and sides in natural oak
- Front panels in lacquered white
- Spoon XL washbasin in white Cristalplant® biobased
- Square tap in polished stainless steel
- Memory mirror with light
- 369 towel holder
- Faro lamps



Evo 21 composition.

N. 12/20

L. 240 cm H 30 cm

- Top and sides in white Carrara marble
- Front panels in teak
- Raso washbasin in white Carrara marble
- Memory Mix tap in gun metal
- Memory mirror with frame
- Dot Line towel holder in black anodized aluminium and white Carrara marble base
- Sen lamp in black anodized aluminium



Evo 21 composition.

N. 13/20

L. 240 cm H 40 cm

- Litorale top-washbasin and sides in white solid surface
- Top in dark oak
- Front panels in lacquered custom color
- Sen tap in black anodized aluminium
- Memory and Constellation mirrors
- Dot Line light



Evo 21 composition.

N. 14/20

L. 160 cm H 40 cm

- Top with Undici integrated washbasin and sides in white solid surface
- Back-splash in white solid surface
- Front panels lacquered orange
- Fez 2 taps white
- Narciso mirror with light and rounded flaps
- Pic-nic towel holder in natural oak
- Sen hook in white



Evo 21 composition.

N. 15/20

L. 160 cm H 70 cm

- Litorale top-washbasin, shelf and back-splash in white solid surface
- Sides and front panels in grey ash oak
- Memory Mix taps in black
- Nudo LED and Lift mirrors
- Sen towel hook in black anodized aluminium



Evo 21 composition.

N. 16/20

L. 200 cm H 70 cm

- Litorale top-washbasin and sides in white solid surface
- Shelves in iroko
- Front panels in lacquered open-pore pine green
- Fez 2 taps in black
- Mach 2 towel holder in black
- Memory mirrors with light



Evo 21 composition.

N. 17/20

L. 200 cm H 40 cm

- Top with integrated Raso washbasins in white solid surface
- Sides and front panels in brown oak
- Memory Mix taps in brushed burnished
- Pic-nic towel holder in brown oak
- Memory and Spai mirrors
- Faro lights



Evo 21 composition.

N. 18/20

L. 200 cm H 40 cm

- Top and sides in white solid surface
- Front panels in dark oak
- Undici Inox washbasins in gun metal
- Memory Mix taps in gun metal
- Memory accessories in gun metal
- Seppia mirrors with light



Evo 21 composition.

N. 19/20

L. 280 cm H 40 cm

- Litorale top-washbasin in white solid surface
- Shelves in green Alpi marble
- Sides and front panels in lacquered open-pore pine green
- Memory taps in brushed burnished
- Surf soap dispenser
- Vitruvio mirrors and Lift container with mirrored door



Evo 21 composition.

N. 20/20

L. 240 cm H. 30 cm

- Tops, sides, front panels, back-splashes in brown oak
- Bjhon 1 freestanding washbasins in brushed grey Pietranova
- Memory Mix taps in brushed burnished
- Vitruvio and Fusilli mirrors



B. Sistema Lato / Lato system



Componenti / components

Casing in plywood with wood covering of various essences.
Depth of the casing 47,7 cm
/ Cassa in multistrato con rivestimento in legno di varie essenze. Profondità della cassa cm 47,7

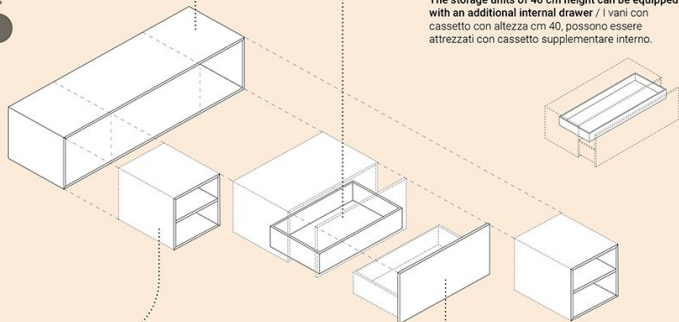

The open compartments have standard lengths of 40 or 60 cm, and are available in the same finish as the casing. Other than the standard measurements, special dimensions are possible / I vani a giorno hanno dimensioni standard cm 40 o 60, sono disponibili nella stessa finitura della cassa. Oltre alle misure standard sono possibili dimensioni speciali



Drawer. The drawers have fixed measures: 40, 60, 80, 100, 120 cm. They are equipped with full extraction runners with push-pull opening and soft closing mechanism / Cassetto. I cassetti hanno misure fisse: cm 40, 60, 80, 100, 120. Sono dotati di guide ad estrazione totale con apertura push-pull e chiusura soft-closing



The storage units of 40 cm height can be equipped with an additional internal drawer / I vani con cassetto con altezza cm 40, possono essere attrezzati con cassetto supplementare interno.

Front. The front of the drawers have fixed measurements: 40, 60, 80, 100 and 120 cm. All the fronts are supported by a MDF panel lacquered dark grey. / Frontale. I frontali dei cassetti hanno misure fisse: cm 40, 60, 80, 100, 120. Tutti i frontali sono supportati da pannello in MDF laccato grigio scuro.



Contenitori, cassetti e frontali / storage units, drawer and frontals

The storage units' casings are available in lengths of 80 to 200 cm, height 20 or 40 cm, depth 47,7 cm. Storage units are also possible with special dimensions when the configuration includes open storage units / Le casse dei contenitori sono disponibili con larghezze da cm 80 a cm 200, altezza cm 20 o 40 e profondità cm 47,7. Sono possibili anche contenitori con dimensioni speciali quando la configurazione prevede i vani a giorno

ALC4_

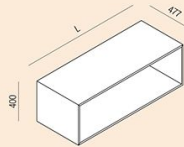

ALC2_

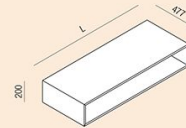

The drawers have fixed measures: 40, 60, 80, 100 and 120 cm. The drawer finish is the same as the casing, when this is in wood; when it is lacquered it must be chosen from the wood finishes available. The drawers are equipped with full extraction runners with push-pull opening and soft-closing mechanism (capacity 40 kg) / I cassetti hanno misure fisse: cm 40, 60, 80, 100, 120. La finitura del cassetto è la stessa della cassa quando questa è in legno; quando è laccata deve essere scelta tra le finiture legno disponibili. I cassetti sono dotati di guide ad estrazione totale con apertura push-pull e chiusura soft-closing (portata 40 kg)

ALD4_

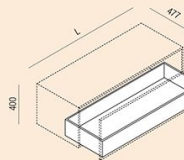

ALD2_

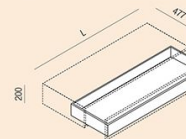

The drawers of the Lato storage units of 40 cm height can be equipped with an additional, internal drawer. The finish of the internal, additional drawer is the same as the main drawer / I cassetti dei contenitori Lato con altezza cm 40, possono essere attrezzati con un cassetto supplementare interno. La finitura del cassetto supplementare interno è la stessa del cassetto principale

ALL_

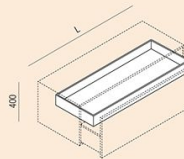

The front of the drawers have fixed measurements: 40, 60, 80, 100 and 120 cm. All the fronts are supported by a MDF panel lacquered dark grey / I frontali dei cassetti hanno misure fisse: cm 40, 60, 80, 100, 120. Tutti i frontali sono supportati da pannello in MDF laccato grigio scuro

ALF4_

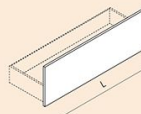

ALF2_

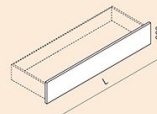

Lato h 20 cm storage units with drawer in natural oak finish. / Contenitore Lato H cm 20 con cassa, frontale e vano a giorno in rovere naturale.

Finiture / finishes

– in wood / in legno:

RT. **natural oak** / rovere naturale

RU. **brown oak** / rovere bruno

RW. **dark oak** / rovere scuro

RC. **grey ash oak** / rovere cenere

PT. **teak** / teak

– in **matt lacquered wood** / in legno laccato opaco:

LZ. **white** / bianco (SIKKENS.ON.00.90)

LG. **dark grey** / grigio scuro (SIKKENS.F2.05.35)

– in **marble** / in marmo:

MC. **white Carrara** / bianco Carrara

GC. **grey Carnic** / grigio Carnico

NM. **black Marquina** / nero Marquina

– in **leather** / in cuoio:

RA. **raw leather** / cuoio raw

VE. **green leather** / cuoio verde

NE. **black leather** / cuoio nero

– in **brass** / in ottone:

BR. **brushed burnished** / brunito spazzolato

NR. **natural brushed** / naturale spazzolato

	Casing / Cassa	Drawers / Cassetti	Fronts / Frontali
RT. natural oak	●	●	●
RU. brown oak	●	●	●
RW. dark oak	●	●	●
RC. grey ash oak	●	●	●
PT. teak	●	●	●
LZ. white	●		●
LG. dark grey	●		●
MC. white Carrara			●
GC. grey Carnic			●
NM. black Marquina			●
RA. raw leather			●
VE. green leather			●
NE. black leather			●
BR. brushed burnished			●
NR. natural brushed			●



Flat XL h 20 cm storage units with drawer in natural oak finish, drawer front in natural oak with push-pull handle. Puzzle large box with cover. / Contenitore Lato H cm 20 con cassa, frontale e vano a giorno in rovere naturale. Piano Flat XL H 12 cm in Cristalplant® biobased bianco con lavabo integrato Ottocento 001, Rubinetto Square. Specchio e accessori Dot line.

Scopri Lato / discover Lato



Q Search



A complete range of cabinets that can be paired with the Agape collection countertop washbasins. Versatile to please all tastes and trends, including the most innovative and original, the drawer fronts come in a variety of finishes: wood, marble, leather, or lacquered and coloured.



Request a consultation

Esempi di composizioni / examples of composition

















C. Sistema Flat XL / Flat XL system



Componenti / components

The Flat XL programme was designed by Benedini Associati and is in production since 1997.

Tops in oak, teak, Exmar, Cristalplant® biobased or in marble, of different thickness and in various types, predisposed to house over countertop, semi-recessed, built-in or integrated washbasins.

Storage units in oak, teak or painted. All these options give life to numerous configurations.

The tops don't include neither the sinks.

Il programma Flat XL è disegnato da Benedini Associati ed è in produzione dal 1997.

Piani in rovere, in teak, in Exmar, in Cristalplant® biobased o in marmo, con spessori diversi ed in diverse tipologie, predisposti per alloggiare lavabi d'appoggio, a semincasso, ad incasso o con lavabi integrati. Contenitori in rovere, teak o laccati. Tutte queste possibilità danno vita a molteplici combinazioni.

I piani non sono compresi di lavabi.

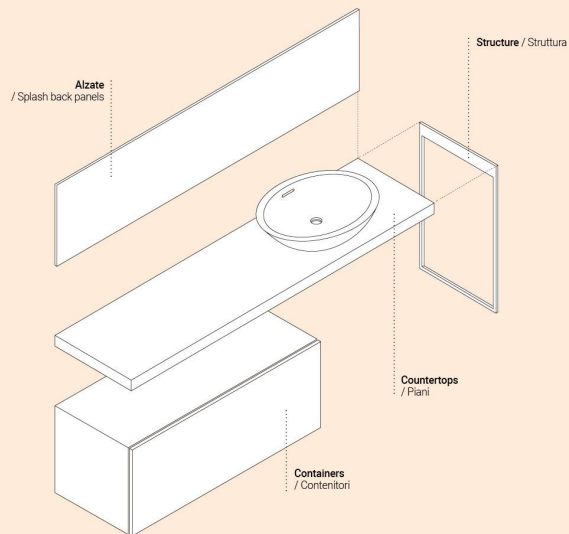

Piani / countertops

Top finishes /
Finiture piano

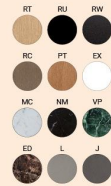

3 cm
Countertop / Piano



Countertops to be rested on cabinets /
Piani da appoggio

AXX_

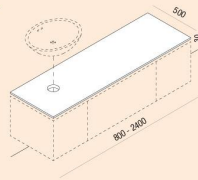

Self-bearing countertops / Piani autoportanti



6 cm
Countertop / Piano



AXM_

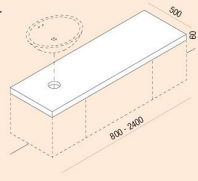

AXN_

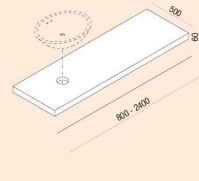

12 cm
Countertop / Piano



AXA_

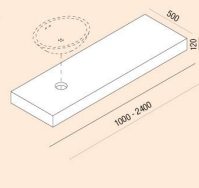

12 cm
Countertop with
fitted edge /
Piano con bordo
attrezzato



Finishes of drawer front /
Finiture frontali



AX1_

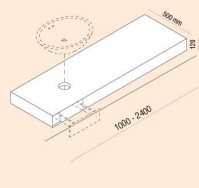

Top finishes /
Finiture piano

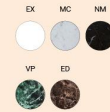

3 cm
Countertop / Piano



Flat XL Ottocento 001

AXXM011Z_
AXXM012Z_

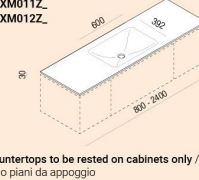

Countertops to be rested on cabinets only /
Solo piani da appoggio

Flat XL Ottocento 002

AXXM021Z_
AXXM022Z_

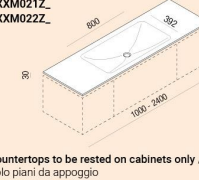

Countertops to be rested on cabinets only /
Solo piani da appoggio

6 cm
Countertop / Piano



AXNM011Z_
AXNM012Z_
AXMM011Z_
AXMM012Z_

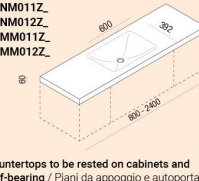

Countertops to be rested on cabinets and
self-bearing / Piani da appoggio e autoportanti

AXNM021Z_
AXNM022Z_
AXMM021Z_
AXMM022Z_

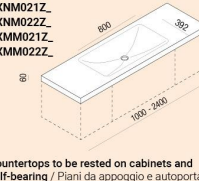

Countertops to be rested on cabinets and
self-bearing / Piani da appoggio e autoportanti

12 cm
Countertop / Piano



AXAM011Z_
AXAM012Z_



Self-bearing countertops only / Solo piani
autoportanti

AXAM021Z_
AXAM022Z_



Self-bearing countertops only / Solo piani
autoportanti

Sono possibili configurazioni con lavabi
singoli e doppi / Sono possibili configurazioni
con lavabi singoli e doppi

Alzate / splash-back panels

Splash-back panels in birch plywood in different finishes, in white Cristalplant® biobased or marble, to be placed against the wall and on the back edge of the countertop.

For the installation of built-in taps it is necessary to evaluate the thickness of the back-splash.

Alzate in multistrato di betulla rivestito in diverse finiture, in Cristalplant® biobased bianco o in marmo da posizionare a parete e in appoggio sul bordo posteriore del piano.

Per l'installazione dei rubinetti ad incasso è necessario valutare lo spessore dell'alzata.

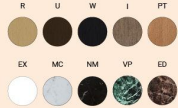
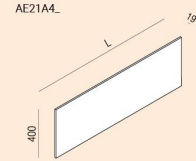

Strutture per piani/ countertop structures

6 and 12 cm thick self-bearing countertops or to be rested on cabinets can be completed with single or double side structures in stainless steel. Available in polished or satin-finished stainless steel or painted black or white.

I piani autoportanti o d'appoggio con spessore cm 6 e cm 12 possono essere completati con strutture laterali in acciaio inox, utilizzabili singole o doppie. Disponibili con finitura inox lucido o satinato oppure laccate in bianco o nero.

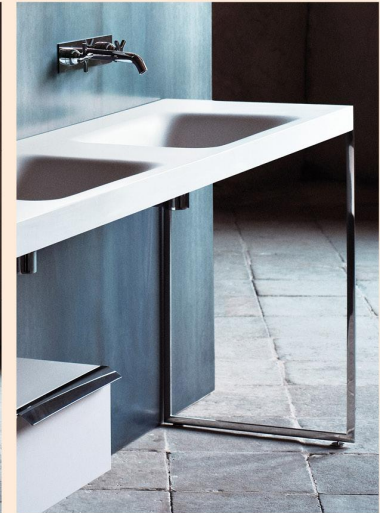
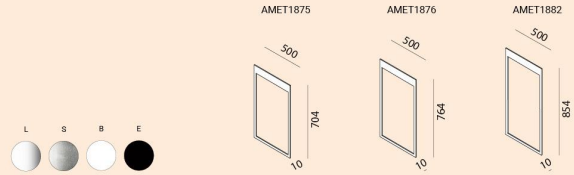

Contenitori e frontali / storage units and frontals

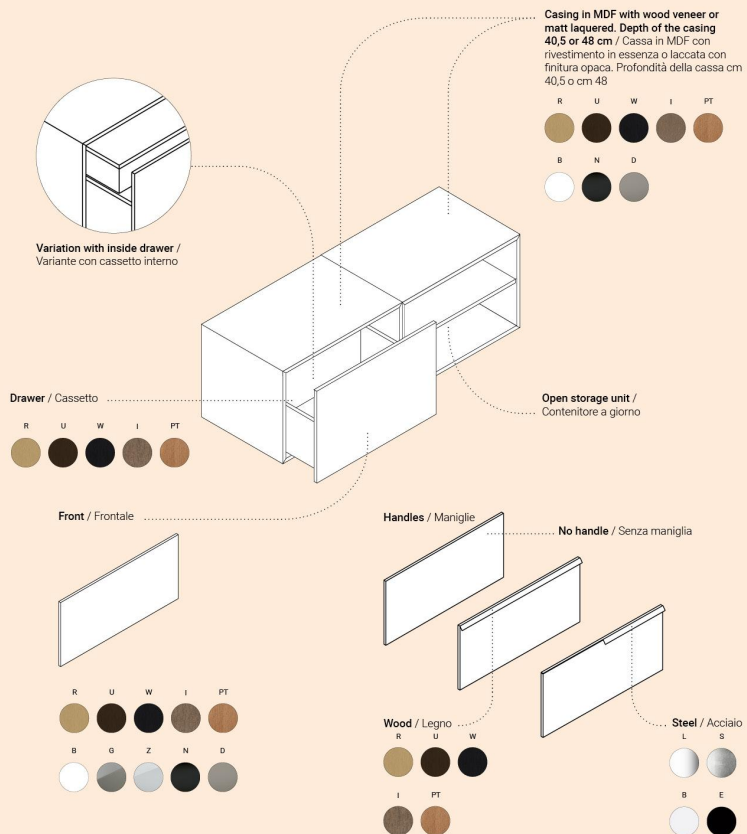

Contenitori e frontali / storage units and frontals

Casing / Cassa



Flat XL container with 50 cm depth / Contenitore Lato o Flat XL con profondità cm 50

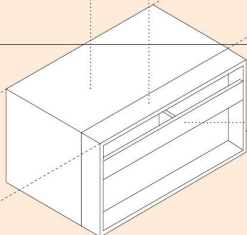

Plus can be combined with the containers of the Lato or Flat XL programs / Plus può essere affiancato ai contenitori dei programmi Lato o Flat XL

Inside drawer / Cassetto interno

Variation with inside drawer / Variante con cassetto interno

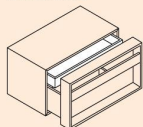

Front / Frontale

Thick front which support the handle for the opening of the drawer / Frontale a forte spessore che sorregge la maniglia per l'apertura del cassetto

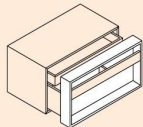

Towel holder / Porta salviette

Horizontal element that serve as towel holder and handle for the opening of the drawer / Elemento orizzontale che serve sia da porta salviette, che da maniglia per l'apertura del cassetto

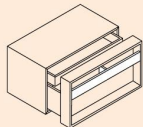

Flat XL h 20 cm storage units with drawer in natural oak finish, drawer front in natural oak with push-pull handle. Puzzle large box with cover. / Composizione Flat XL in rovere naturale, lavabo B15, contenitori Plus con casse e frontali in rovere naturale. Rubinetto Square. Specchio Nudo LED.

Cassetti / drawer

L 40 / 60 / 80 / 100

AFXM0135_

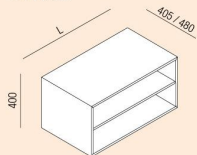

Open storage units / Contenitore a giorno

L 40 / 60 / 80 / 100 / 120

AFXM0151_

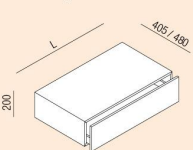

Storage unit with drawer / Contenitore con cassetto

AFXM0170_

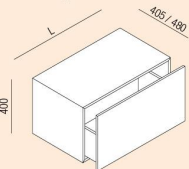

Storage unit with drawer / Contenitore con cassetto

AFXM0198_

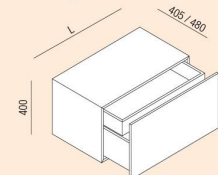

Storage unit with drawer and internal drawer / Contenitore con cassetto e cassetto interno

L 60 / 80 / 100 / 120

AFXM0174_

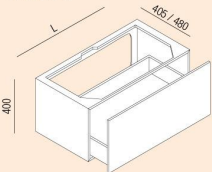





Storage unit under basin with drawer / Contenitore sottolavabo con cassetto



Flat XL h 40 cm storage units with large drawer and internal drawer in brown oak finish, drawer front in matt white painted and handle in brown oak. / Composizione Flat XL con piano da appoggio H cm 3 in rovere bruno, cassetto e cassetto interno H cm 40 in rovere bruno, frontali in laccato bianco opaco, maniglia in rovere bruno.

Finiture / finishes

	Countertops (thickness) / Piani (spessore)			Front / Frontali	Casing / Cassa	Splash back panels / Alzate	Structures / Strutture
	cm 3	cm 6	cm 12				
- in solid surface / in solid surface:							
EX. Exmar-Cristalplant® / Exmar-Cristalplant®		•	•			•	
- in marble / in marmo:							
MC. white Carrara / bianco Carrara		•	•			•	
NM. black Marquina / nero Marquina		•	•			•	
VP. green Alpi / verde Alpi		•	•			•	
ED. dark Emperador / Emperador dark		•	•			•	
- in wood / in legno:							
RT/R. natural oak / rovere naturale		•	•	•	•	•	
RU/U. brown oak / rovere bruno		•	•	•	•	•	
RW/W. dark oak / rovere scuro		•	•	•	•	•	
RC/L. grey ash oak / rovere cenere		•	•	•	•	•	
PT. teak / teak		•	•	•	•	•	
- in raw earth / in terra cruda							
J. dark grey / grigio scuro		•	•				
L. light grey / grigio chiaro		•	•				
- in matt lacquered wood / in legno laccato opaco:							
B. white / bianco (SIKKENS.ON.00.90)				•	•		
N. dark grey / grigio scuro (SIKKENS.F2.05.35)				•	•		
Q/D. light grey / grigio chiaro (SIKKENS.F2.05.65)				•	•		
- in Exacril / in Exacril:							
Z. white / bianco				•			
G. grey / grigio				•			
- in stainless steel / in acciaio							
L. polished finished / inox lucido							•
S. satin finished / inox satinato							•
B. matt white paint / bianco opaco (RAL9003)							•
E. matt black painted / nero opaco (RAL9005)							•

Scopri Flat XL / discover Flat XL

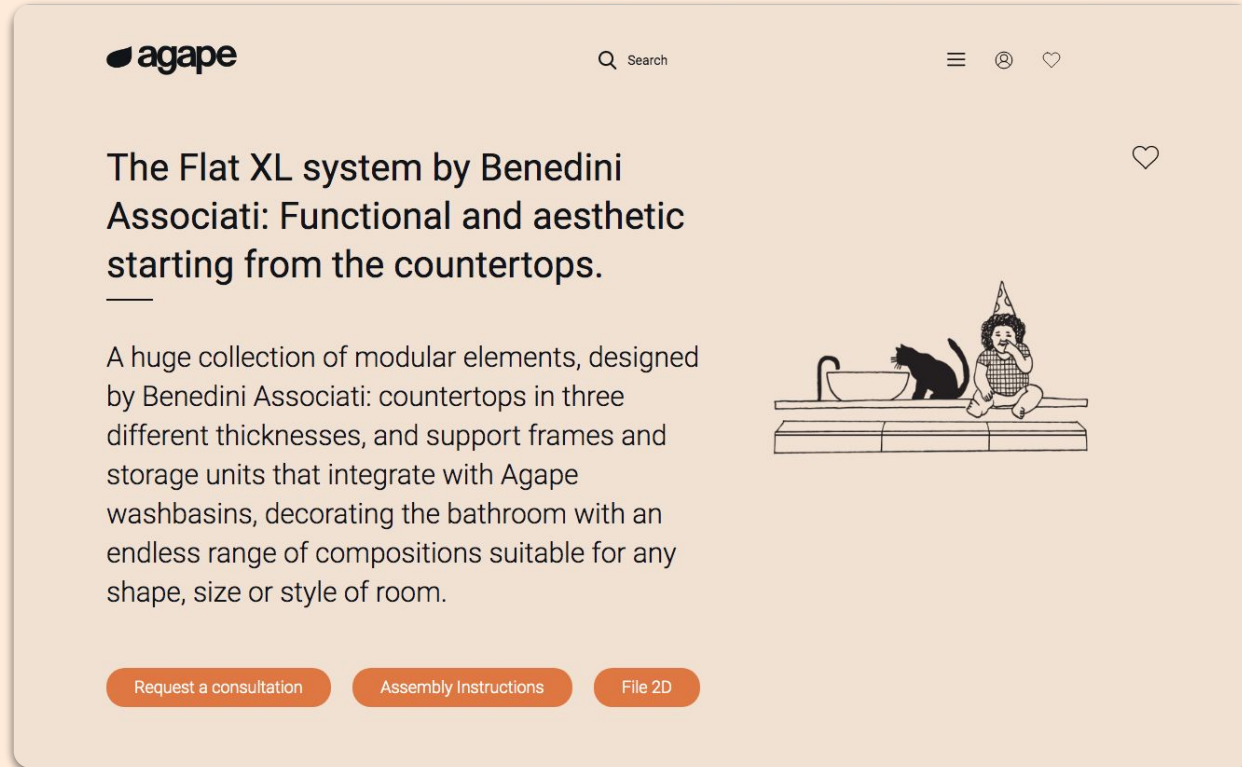

The screenshot shows a web page for the Agape Flat XL system. At the top left is the Agape logo. To its right is a search bar with a magnifying glass icon and the text "Search". Further right are three icons: a hamburger menu, a globe, and a heart. The main heading reads "The Flat XL system by Benedini Associati: Functional and aesthetic starting from the countertops." Below this is a paragraph: "A huge collection of modular elements, designed by Benedini Associati: countertops in three different thicknesses, and support frames and storage units that integrate with Agape washbasins, decorating the bathroom with an endless range of compositions suitable for any shape, size or style of room." To the right of the text is a line drawing of a child wearing a party hat sitting on a countertop next to a black cat and a white washbasin. At the bottom of the page are three orange buttons: "Request a consultation", "Assembly Instructions", and "File 2D".

agape Search

The Flat XL system by Benedini Associati: Functional and aesthetic starting from the countertops.

A huge collection of modular elements, designed by Benedini Associati: countertops in three different thicknesses, and support frames and storage units that integrate with Agape washbasins, decorating the bathroom with an endless range of compositions suitable for any shape, size or style of room.

[Request a consultation](#) [Assembly Instructions](#) [File 2D](#)

Esempi di composizioni / examples of composition





















D. Sistema Rigo / Rigo system



Componenti / components

Rigo is a bathroom furnishing system with a strong architectural inspiration. Two parallel beams run along the wall and create a linear top on which washbasins and accessories are placed.

A detailed series of trays and containers and a mirror allow multiple configurations, from the simplest to the most elaborate. The combination of marble, wood and aluminium create a sophisticated aesthetic and textured look.

Rigo is a minimalist take, a contemporary synthesis, on the traditional bathroom setting designed by Patricia Urquiola.

Rigo è un sistema di arredo bagno di forte ispirazione architettonica. Due travi parallele corrono lungo il muro e definiscono uno spazio di appoggio lineare su cui vengono disposti lavabo e accessori.

Una serie dettagliata di vassoi, contenitori e uno specchio, consentono molteplici configurazioni del sistema, dalle più semplici a quelle più articolate. L'accostamento di marmo, legno e alluminio conferisce ricercatezza estetica e materica.

Rigo è una traduzione minimale, una sintesi contemporanea dell'ambiente bagno tradizionale disegnato da Patricia Urquiola.

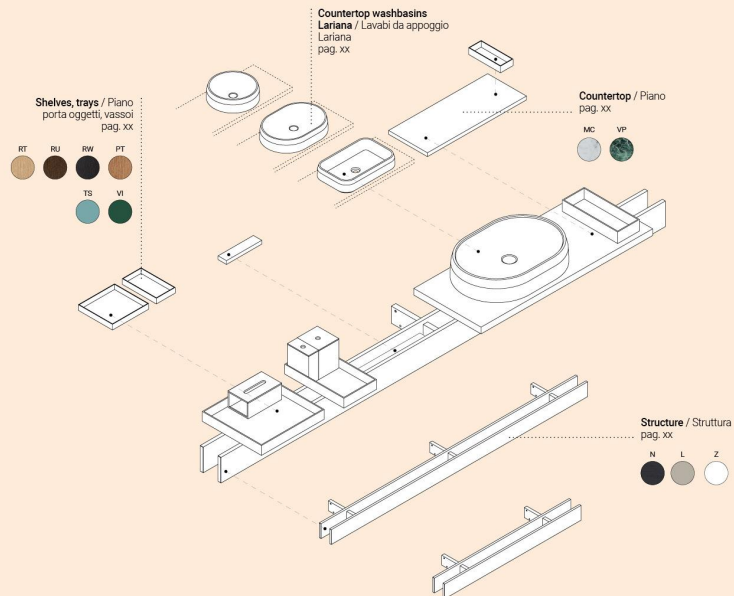

Struttura / structure

Support structure for washbasin and accessories consisting of two parallel joined bars, fixed on the wall. Created in black satin-finish anodised aluminium or lacquered in white (RAL9003), light grey (RAL7044) or in other RAL colours on request, it has a minimum length of 120,4 cm and a maximum length of 300,4 cm.

Struttura di sostegno per lavabo e accessori costituita da due barre parallele collegate tra di loro e fissate alla parete. Realizzata in alluminio anodizzato spazzolato nero o verniciata in bianco (RAL9003), grigio chiaro (RAL7044) o con altri colori RAL a richiesta, ha lunghezza minima cm 120,4 e massima cm 300,4.



Structure with two supports / Struttura con due supporti

ARIGS120	L 1204
ARIGS140	L 1404
ARIGS160	L 1604
ARIGS180	L 1804

Structure with three supports / Struttura con tre supporti

ARIGS200	L 2004
ARIGS220	L 2204
ARIGS240	L 2404
ARIGS260	L 2604
ARIGS280	L 2804
ARIGS300	L 3004

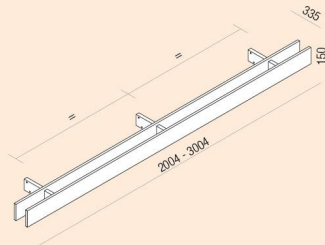
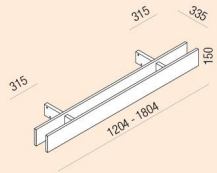

Struttura / structure

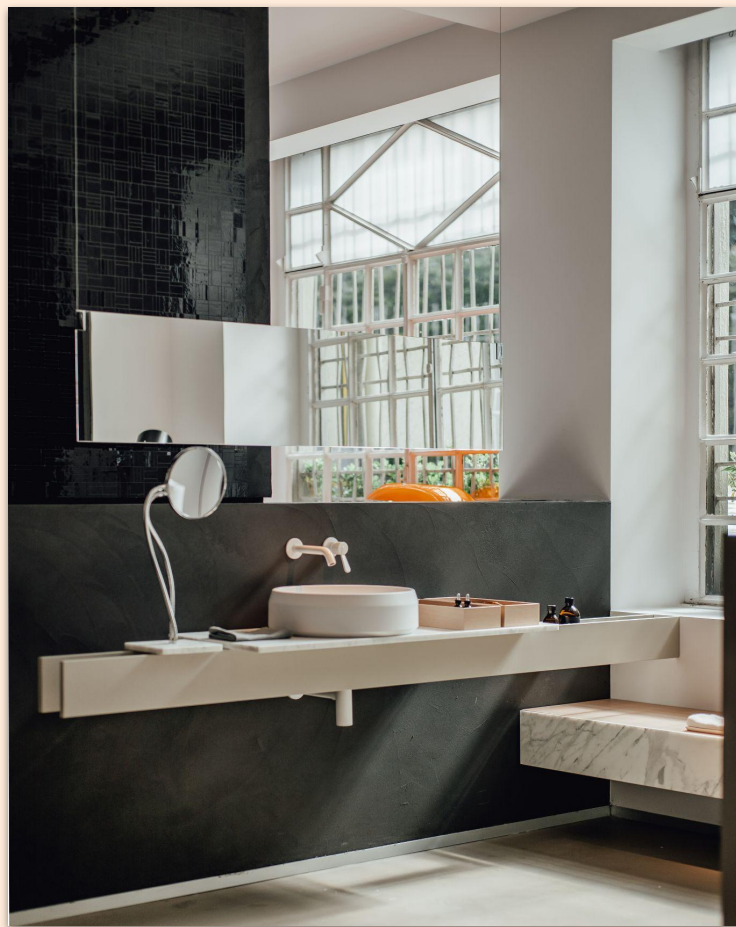

Piani / countertop

Washbasin or tray support top made of white Carrara or green Alpi marble to fix to the Rigo structure.

The washbasin countertop can be positioned along the entire length of the structure and all the Lariana washbasins can be positioned on this.

The tap cannot be placed on the countertop.

The tray can be freely positioned between the two aluminium bars. The resting surface is 85 mm from the upper structure edge.

Piano portalavabo o portaoggetti realizzato in marmo bianco di Carrara o in marmo verde Alpi da fissare alla struttura Rigo.

Il piano portalavabo può essere posizionato su tutta la lunghezza della struttura e su questo è possibile collocare tutti i lavabi Lariana. Non è possibile inserire il rubinetto sul piano.

Il piano porta oggetti si posiziona liberamente tra le due barre in alluminio, la superficie di appoggio è a 85 mm dal filo superiore della struttura.

ARIGP120

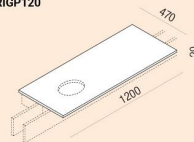

ARIGM50

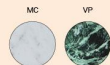
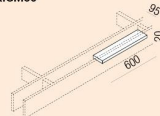

Vassoi / trays

Wooden trays in various sizes and finishes to accessorise the Rigo structure.

Two trays with the same depth and two different widths to be fixed directly and freely to the structure, while a third tray can be placed on the countertop.

The trays are made of solid oak with natural, brown or dark oak finish or in reconstituted wood with teak finish or open pore painted in green pine (RAL6028) or pastel turquoise (RAL6034).

The trays are made to hold the various elements which make up the Puzzle series.

Vassoi porta oggetti in legno in diverse dimensioni e finiture per accessorizzare la struttura Rigo.

Due vassoi con la stessa profondità e con due larghezze diverse si fissano direttamente e liberamente alla struttura, un terzo vassoio può essere collocato sul piano.

I vassoi sono realizzati in rovere massello con finitura naturale, bruno, scuro o in legno precomposto con finitura teak oppure verniciati a poro aperto in verde pino (RAL6028) o turchese pastello (RAL6034).

I vassoi sono predisposti dimensionalmente per alloggiare i vari elementi che compongono la serie Puzzle.

ARIGV44

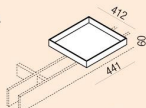

ARIGV22

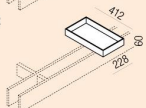

ARIGV15

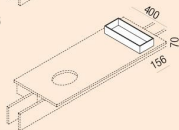

Vassoi interni / internal trays

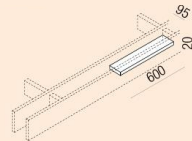
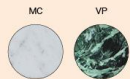

Specchi / mirrors

Specchio tondo bifacciale, un lato ingranditore, con cornice e tubi flessibili cromati da fissare liberamente sulla struttura Rigo.

La base in marmo è disponibile in marmo bianco di Carrara o in verde Alpi.

Fattore di ingrandimento 2, lunghezza tubi 500 mm.

Round, double-sided mirror, one side with magnification, with frame and flexible, chromed pipes to fix on the Rigo structure. The marble base is available in white Carrara marble or verde Alpi.

Magnifying power: 2. Length of tubes: mm 500 (19" 3/4).

ARIGFUS

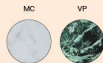
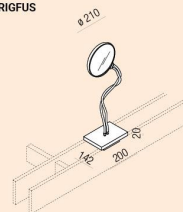



Search



Rigo System by Patricia Urquiola: Synthesis and Modularity made to measure.



Rigo, renewing the intense collaboration with Patricia Urquiola since 2004, becomes with its parallel beams running along the wall, the most recent manifestation of what Agape means by Bathroom Architecture.



Request a consultation

Configure

Technical Specification Sheet

Assembly Instructions

File 2D

File 3D

Esempi di composizioni / examples of composition





















Grazie. Domande? /
thank you. questions?

