

**PREVIEW
NEWS LEMA
→ 2022**

LEMA



We are pleased to present a preview of some novelties from the upcoming Lema 2022 collection, which will be presented in June at the Salone del Mobile in Milan. Compositional flexibility, maximum customisation, refined aesthetics and high quality: these are the keys to Lema's success declined in three new elegant and versatile products. Once again, Lema's Made in Italy concept skilfully combines innovation and tradition, proposing an ever-innovative product with a refined and contemporary design.

Abbiamo il piacere di proporvi in anteprima alcune novità della prossima collezione Lema 2022, che verrà presentata a giugno in occasione del Salone del Mobile di Milano. Flessibilità compositiva, massima personalizzazione, estetica raffinata e alta qualità: sono queste le chiavi del successo di Lema declinate in tre nuovi prodotti eleganti e versatili. Ancora una volta il Made in Italy di Lema unisce sapientemente innovazione e tradizione, per proporre un prodotto sempre più innovativo, dal design ricercato e contemporaneo.

MADE IN ITALY
VERSATILE
ELEGANT
SARTORIAL DETAILS
TIMELESS
INNOVATIVE

Glee is a modular free-standing sofa that stands out for its essential lines and soft volumes. Versatility is its distinctive trait: *Glee* is able to fit into any space and dialogue with any furniture style. It is possible to choose the width of the central body, of the two terminals and of the pouf *with a 5 cm step* between the maximum and the minimum size of these sofa's elements, in order to fully adapt them to different functional and aesthetic needs. The attention to details, sartorial elements and personalisation, fil rouge of all Lema's designs, is enhanced in the Armadio al centimetro system as well as in *Glee*: the careful selection of materials allows different chromatic and material combinations, giving life to this new elegant "tailor-made" proposal, perfect symbol of Officinadesign Lema's constant research.

Glee è il divano a terra modulare che si distingue per le linee essenziali e i volumi morbidi. Capace di inserirsi in ogni ambiente grazie alle sue dimensioni contenute e di dialogare con qualsiasi stile di arredamento, *Glee* fa della versatilità il suo tratto distintivo aggiungendo un tocco di freschezza e contemporaneità agli ambienti. Sarà possibile scegliere la larghezza con passo 5 cm tra la misura massima e la misura minima per adattarlo pienamente alle diverse esigenze funzionali, di spazio ed estetiche. La cura sartoriale del dettaglio e l'alta personalizzazione, fil rouge di ogni prodotto Lema, si esalta nell'Armadio al Centimetro così come nella novità *Glee*: l'attenta selezione di materiali, permette diverse combinazioni cromatiche e materiche dando vita a questa nuova elegante proposta "su misura", emblema della ricerca costante di Officinadesign Lema.

GLEE SOFA
→ **LEMA 2022**

Glee

Composition 1



①

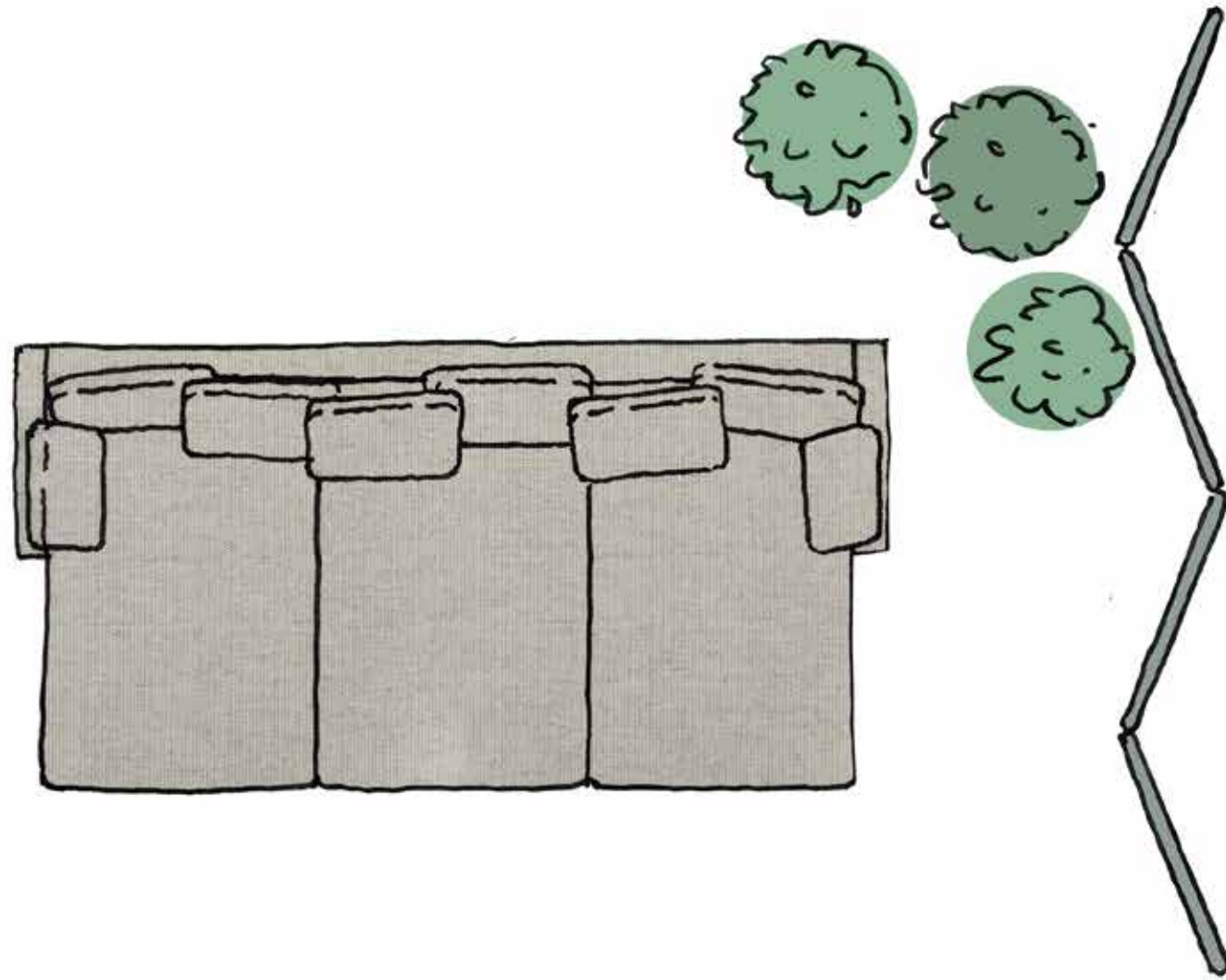

Sofa Fabric – Tessuti Divano

1– Fenice – TDD 850

Products – Prodotti

1– LT40, Storage System

Lct, Lcl, Walnut L

Lct, Lcl, Noce L

Glee

Composition 1



Glee

Composition 1



Glee

Composition 1



Glee

Composition 1



Glee

Composition 2

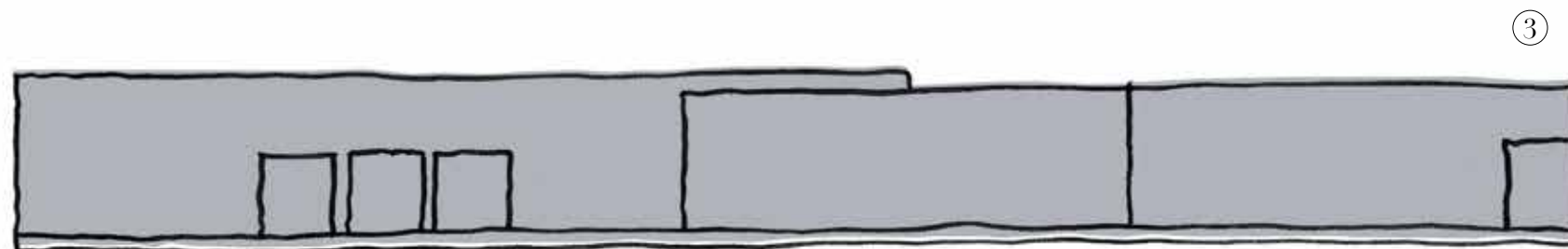
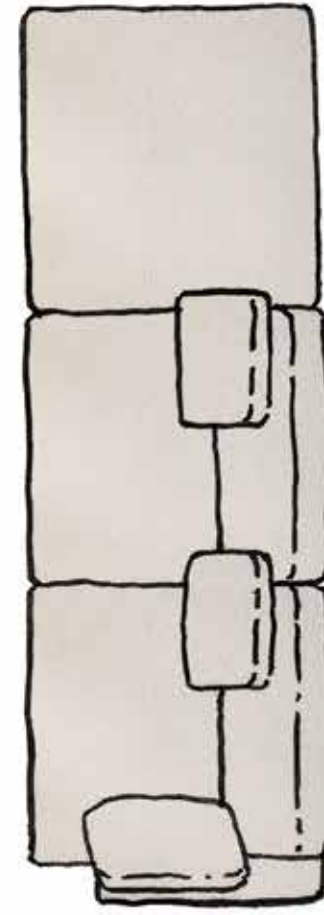
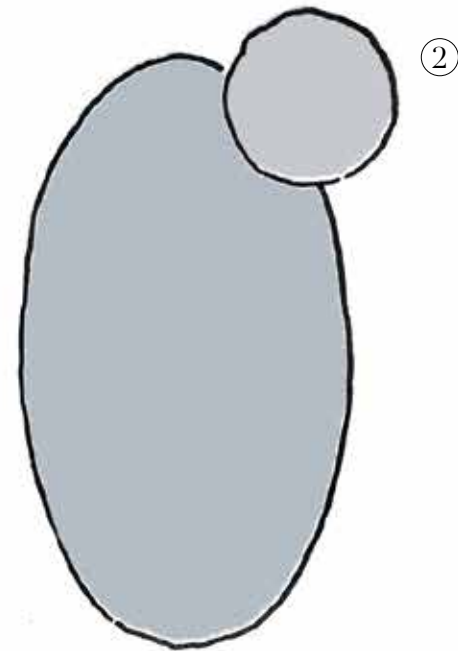
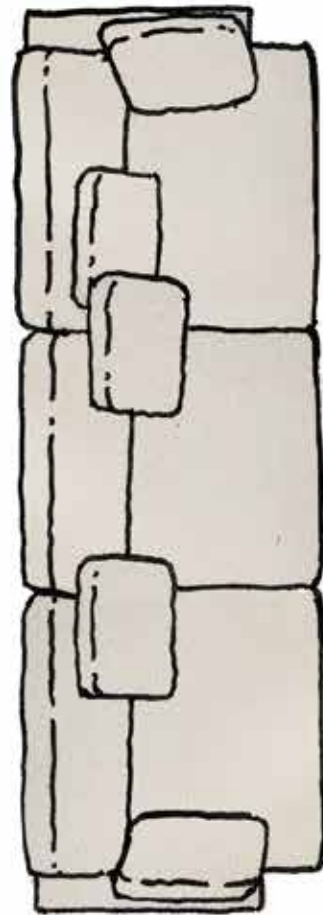
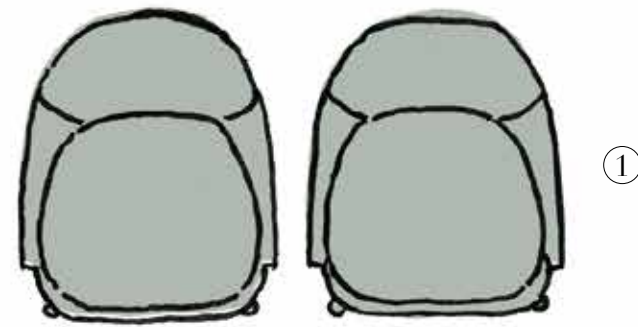

Sofa Fabric – Tessuti Divano

1– Tabit – TDE 861

Products – Prodotti

1– Fantino, Armchair, Poltrona
Fabric, Tessuto TDC 134 Cassiopea

2– Mr. Zheng, Coffee Table, Tavolino
Round, Tondo: Lct Salvia 853
Oval, Ovale: Walnut L, Noce L

3– LT40, Storage System
Lct, Lcl, Walnut L
Lct, Lcl, Noce L

Glee

Composition 2



Glee

Composition 2



Glee

Composition 2

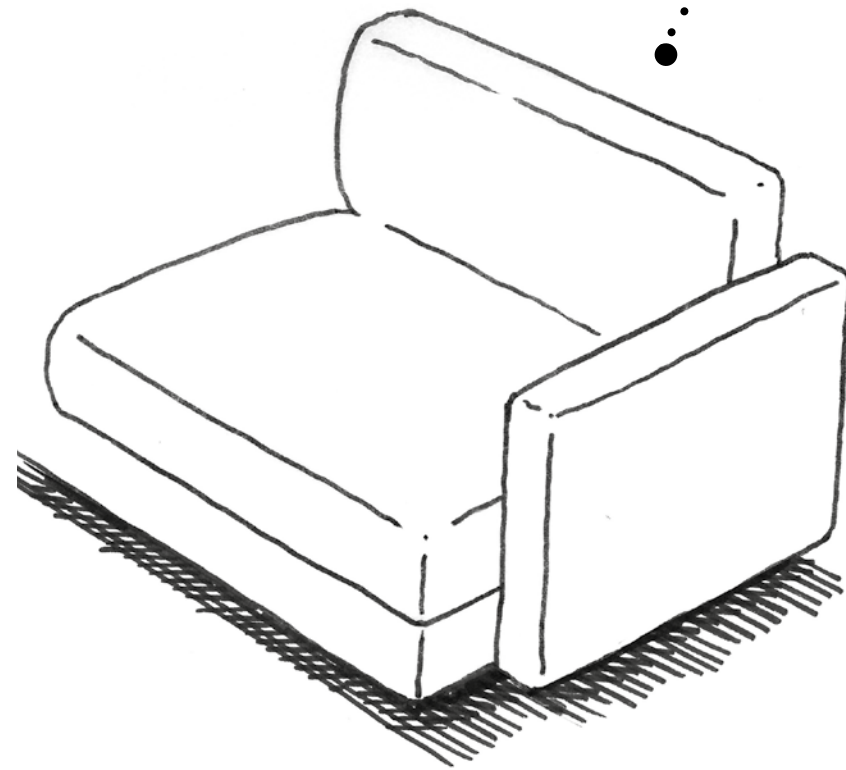

The delicate elegance of the *Glee* sofa is enhanced by the fine balance between geometric shapes and volumes and by the constant dialogue between seat and structure.

L'eleganza discreta del divano *Glee* è data dall'equilibrio di forme e volumi geometrici e dal dialogo tra seduta e struttura.



Glee

Custom units

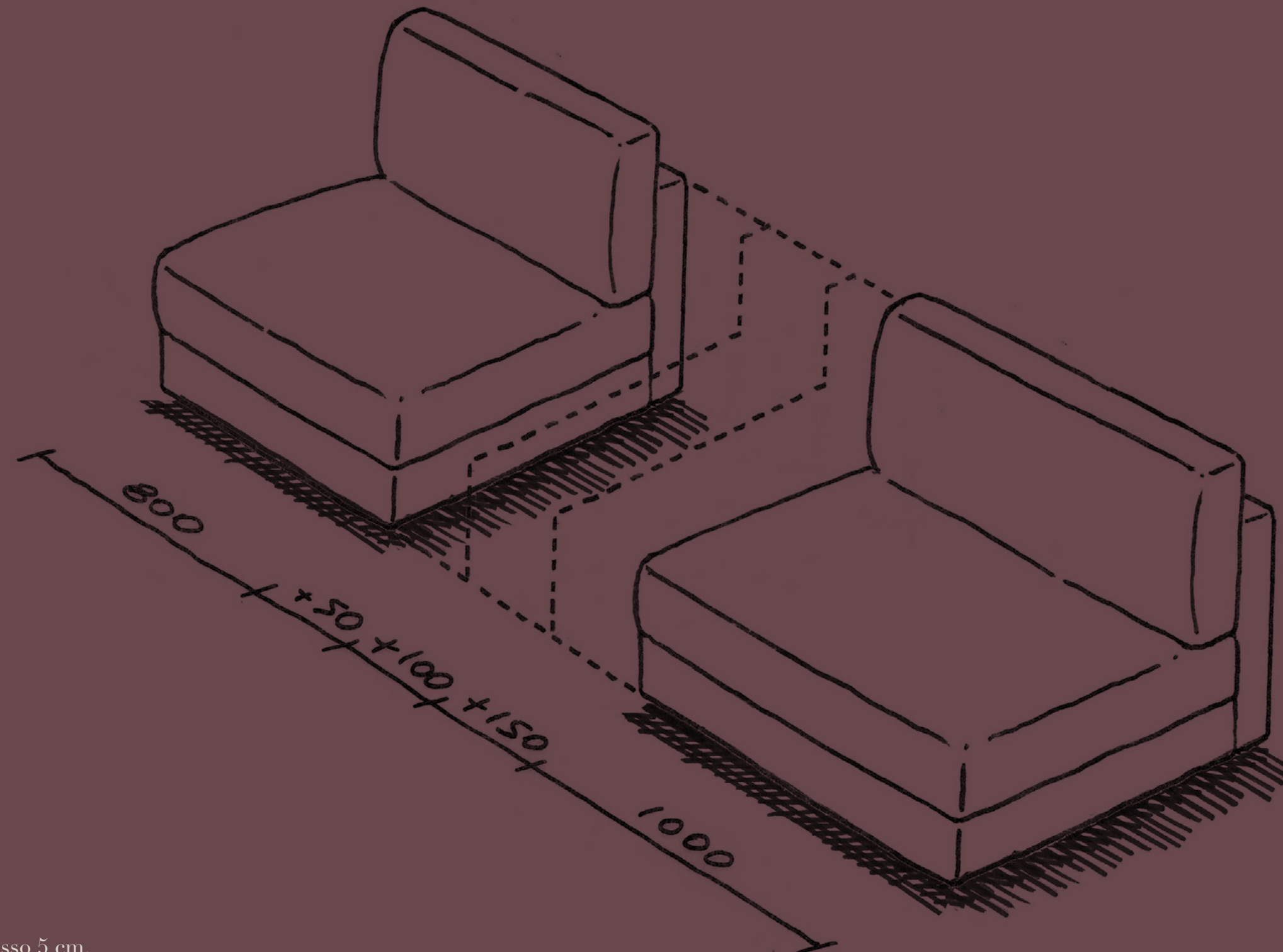

Unit that may vary with a 5 cm step in width.
Elemento che può variare in larghezza con passo 5 cm.

Glee

Custom units

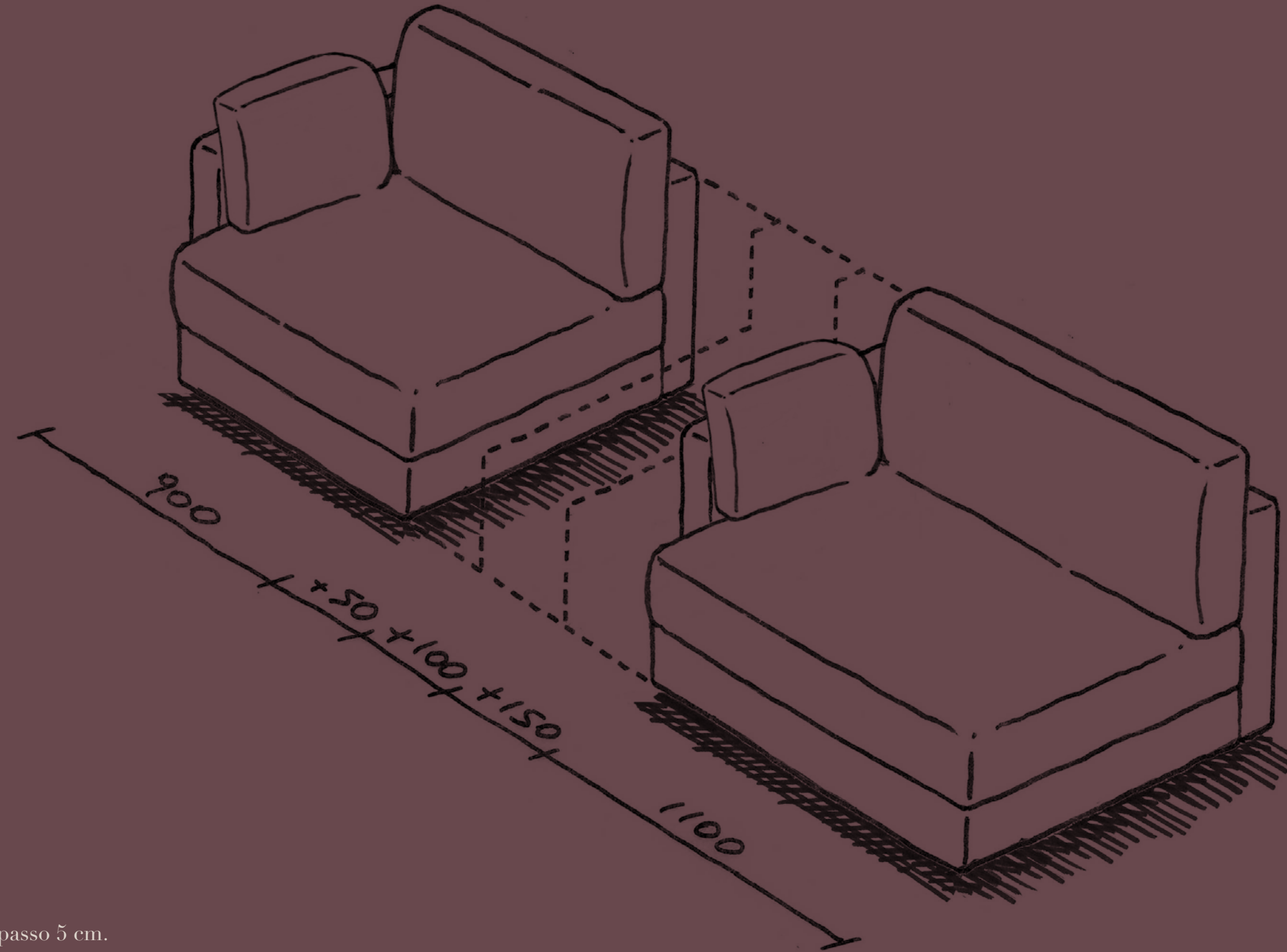

Unit that may vary in 5 cm step in with.
Elemento che può variare in larghezza con passo 5 cm.

Glee

Abacus

Sofas - Divani
H. 790 - 31"
P. 1000 - D. 39¼"

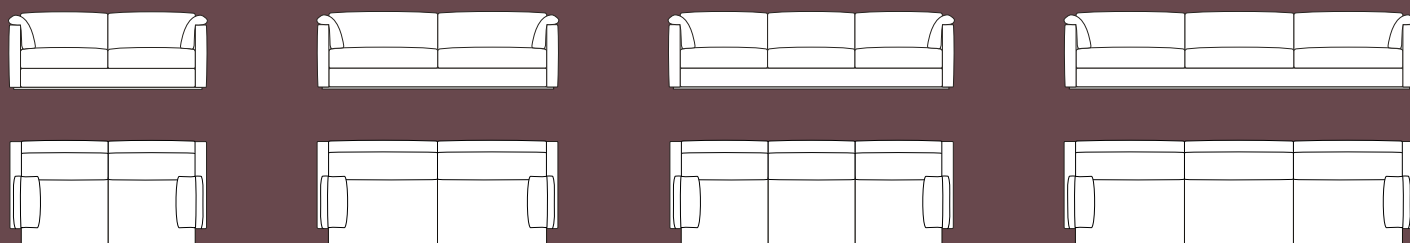

1800 - 70¾"

2200 - 86½"

2600 - 102¼"

3200 - 126"



1000 - 39¼"

End unit
Elementi terminali

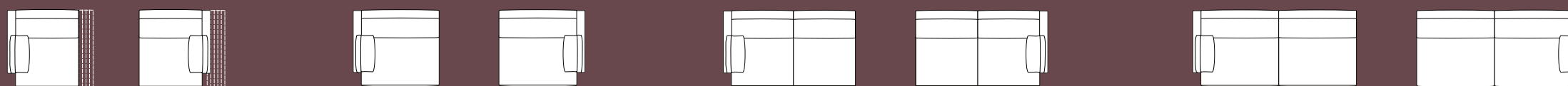

SX
900 - 35" *

DX
900 - 35" *

SX
1100 - 43¼"

DX
1100 - 43¼"

SX
1700 - 67"

DX
1700 - 67"

SX
2100 - 82¾"

DX
2100 - 82¾"

(900 - 950 - 1000 - 1050 - 1100)
(35" - 37½" - 39¼" - 41¾" - 43¼")

Central unit
Elementi centrali

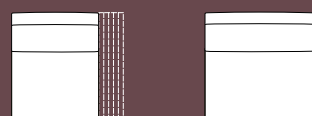

800 - 31¼" * 1000 - 39¼" *

(800 - 850 - 900 - 950 - 1000)
(31¼" - 33½" - 35" - 37¼" - 39¼")

Corner unit
Elementi angolari

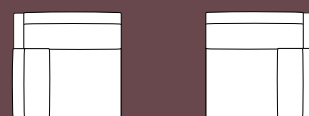

SX
1000 - 39¼"

DX
1000 - 39¼"

End dormeuse
Dormeuse terminali

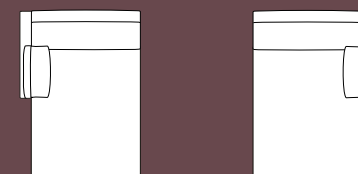

SX
1100 - 43¼"

DX
1100 - 43¼"

Central dormeuse
Dormeuse centrale



1000 - 39¼"

Pouf
P. 1000 - D. 39¼"

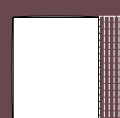

800 - 31¼" *

(800 - 850 - 900 - 950)
(31¼" - 33½" - 35" - 37¼")

Square pouf
Pouf quadrato
P. 850-900-950-1000
(33½" - 35" - 37¼" - 39¼")



1000 - 39¼" **

(800 - 850 - 900 - 950)
(31¼" - 33½" - 35" - 37¼")

* Units marked * may vary with a 5 cm step in width.

** Units marked ** may vary in steps of 5cm in width and depth. (maintain square shape)

* Gli elementi con * sono quelli che possono variare in larghezza con passo 5cm.

** L'elemento con ** può variare con passo 5cm in larghezza e profondità. (mantiene la forma quadrata)

Glee

Abacus

Structural backrest cushions
Cuscini strutturali schienali
550 x 550

Sofas - Divani
H. 790 - 31"
P. 1000 - D. 39¼"

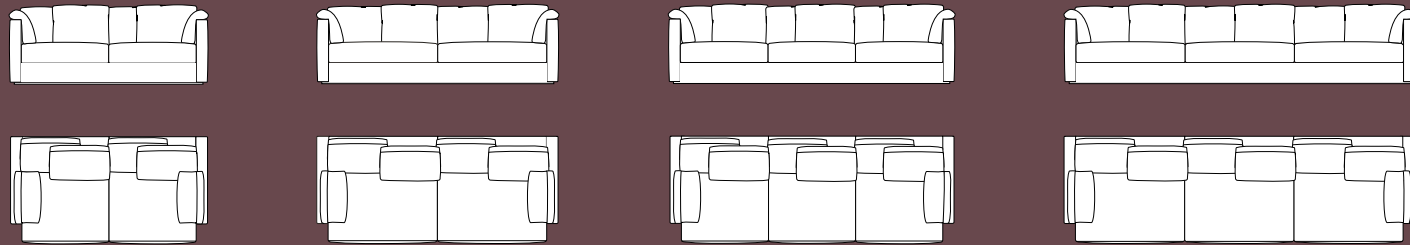

1800 - 70¾"

2200 - 86½"

2600 - 102¼"

3200 - 126"



1000 - 39¼"

End unit
Elementi terminali



SX
900 - 35" *

DX
900 - 35" *

SX
1100 - 43¼"

DX
1100 - 43¼"

SX
1700 - 67"

DX
1700 - 67"

SX
2100 - 82¾"

DX
2100 - 82¾"

(900 - 950 - 1000 - 1050 - 1100)
(35" - 37½" - 39¼" - 41¾" - 43¼")

Central unit
Elementi centrali

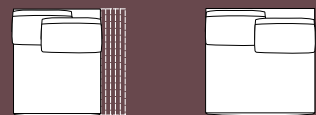

800 - 31¼" * 1000 - 39¼" *

(800 - 850 - 900 - 950 - 1000)
(31¼" - 33½" - 35" - 37¼" - 39¼")

Corner unit
Elementi angolari



SX
1000 - 39¼"

DX
1000 - 39¼"

End dormeuse
Dormeuse terminali

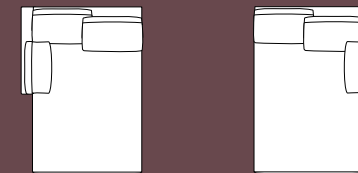

SX
1100 - 43¼"

DX
1100 - 43¼"

Central dormeuse
Dormeuse centrale

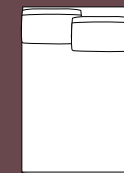

1000 - 39¼"

Pouf
P. 1000 - D. 39¼"

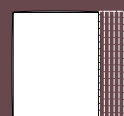

800 - 31¼" *

(800 - 850 - 900 - 950)
(31¼" - 33½" - 35" - 37¼")

Square pouf
Pouf quadrato
P. 850-900-950-1000
(33½" - 35" - 37¼" - 39¼")



1000 - 39¼" **

(800 - 850 - 900 - 950)
(31¼" - 33½" - 35" - 37¼")

* Units marked * may vary with a 5 cm step in width.

** Units marked ** may vary in steps of 5cm in width and depth. (maintain square shape)

* Gli elementi con * sono quelli che possono variare in larghezza con passo 5cm.

** L'elemento con ** può variare con passo 5cm in larghezza e profondità. (mantiene la forma quadrata)

A game between rigid and soft shapes: the *Groovy* sofa embodies the essence of relaxation in a slender structure. A sofa that blooms with many petals, the armrests of *Groovy* open slightly outwards focusing on the soft cushions. Square shapes and extra softness: the balance between comfort and linearity is the central point around which Officinadesign Lema has built the whole project of the *Groovy* sofa, making it the perfect interpreter of a philosophy based on relaxation; where comfort and modularity are the fundamental characteristics. *Groovy* is supported by non-visible feet, the supporting structure is in leather whilst the cushions can be covered in fabric or leather. The game of combinations passes from a material to a chromatic surface thanks to the possibility of combining elements of different colours, fabrics and textures.

Gioco di incastri tra forme rigide e morbide: il divano *Groovy* racchiude l'essenza del relax in una struttura esile e slanciata. Come petali che si schiudono, i braccioli di *Groovy* si aprono lievemente verso l'esterno per portare in risalto la morbida cuscinatura. Forme squadrate ed extra morbidezza: l'equilibrio tra comfort e linearità è il punto centrale attorno al quale Officinadesign Lema ha costruito tutto il progetto del divano *Groovy* rendendolo il perfetto interprete di una filosofia improntata al relax che trova nel comfort e nella modularità i suoi caratteri fondamentali. *Groovy* è sostenuto da piedini non a vista, la scocca, disponibile sia in pelle che in tessuto così come la cuscinatura, rende possibile un infinito gioco di combinazioni materiche e di colori.

GROOVY **SOFA**
→ **LEMA** **2022**

Groovy

Composition 1

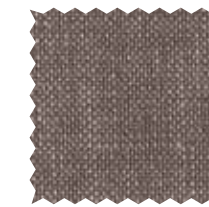
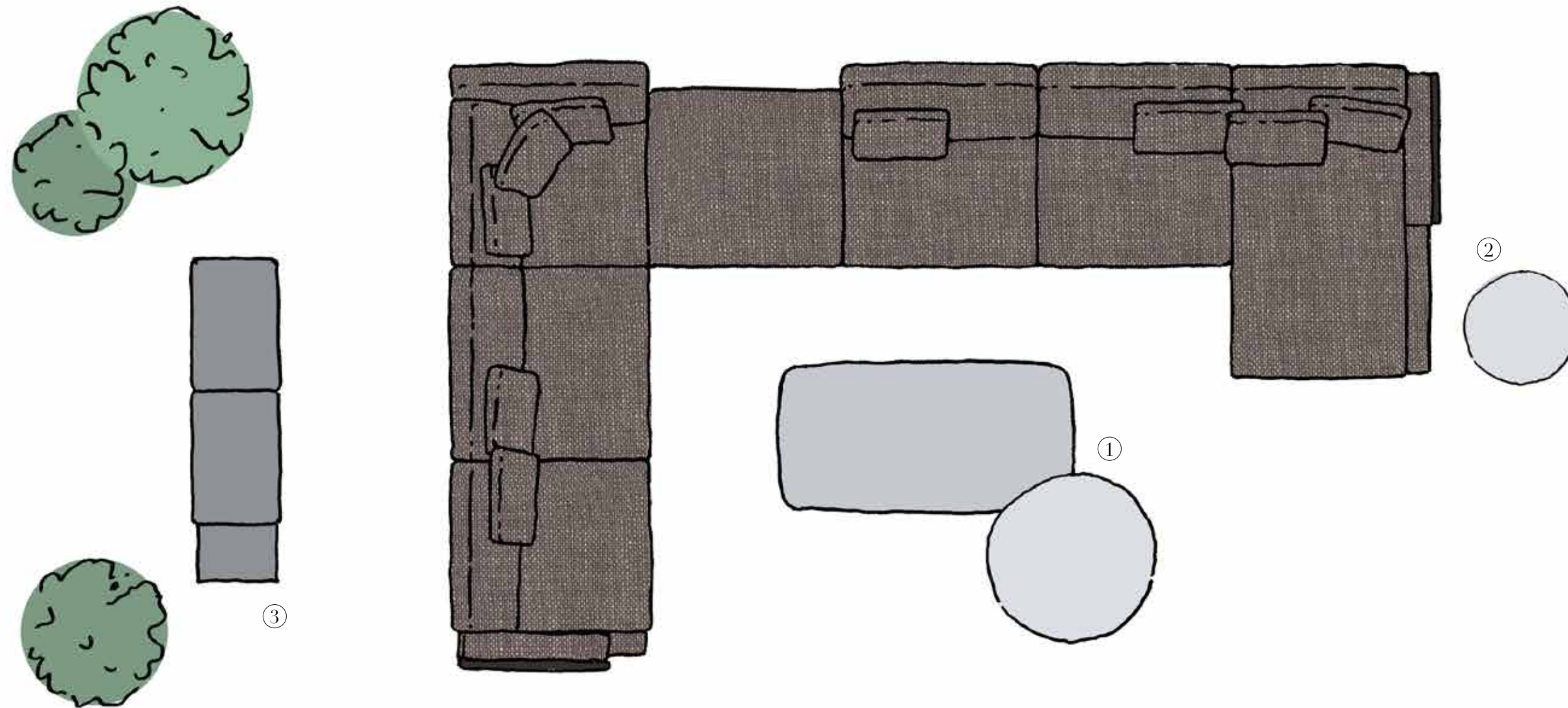

Sofa Fabric – Tessuto Divano

1– Fabric, Tessuto Aberdeen – TDC 682

2– Leather, Pelle PT 074 – Cervo

Products – Prodotti

1– Oydo, Coffee table, Tavolino
Round, Tondo: Carbone oak, Rovere carbone
Rectangular, Rettangolare: LCL Scoglio 212

2– Sign, Coffee table, Tavolino
Lcl Talpa 233

3– Uma, Bench, Panca
Leather, Pelle Super PS2266

Groovy

Composition 1



Groovy

Composition 1



Groovy

Composition 1

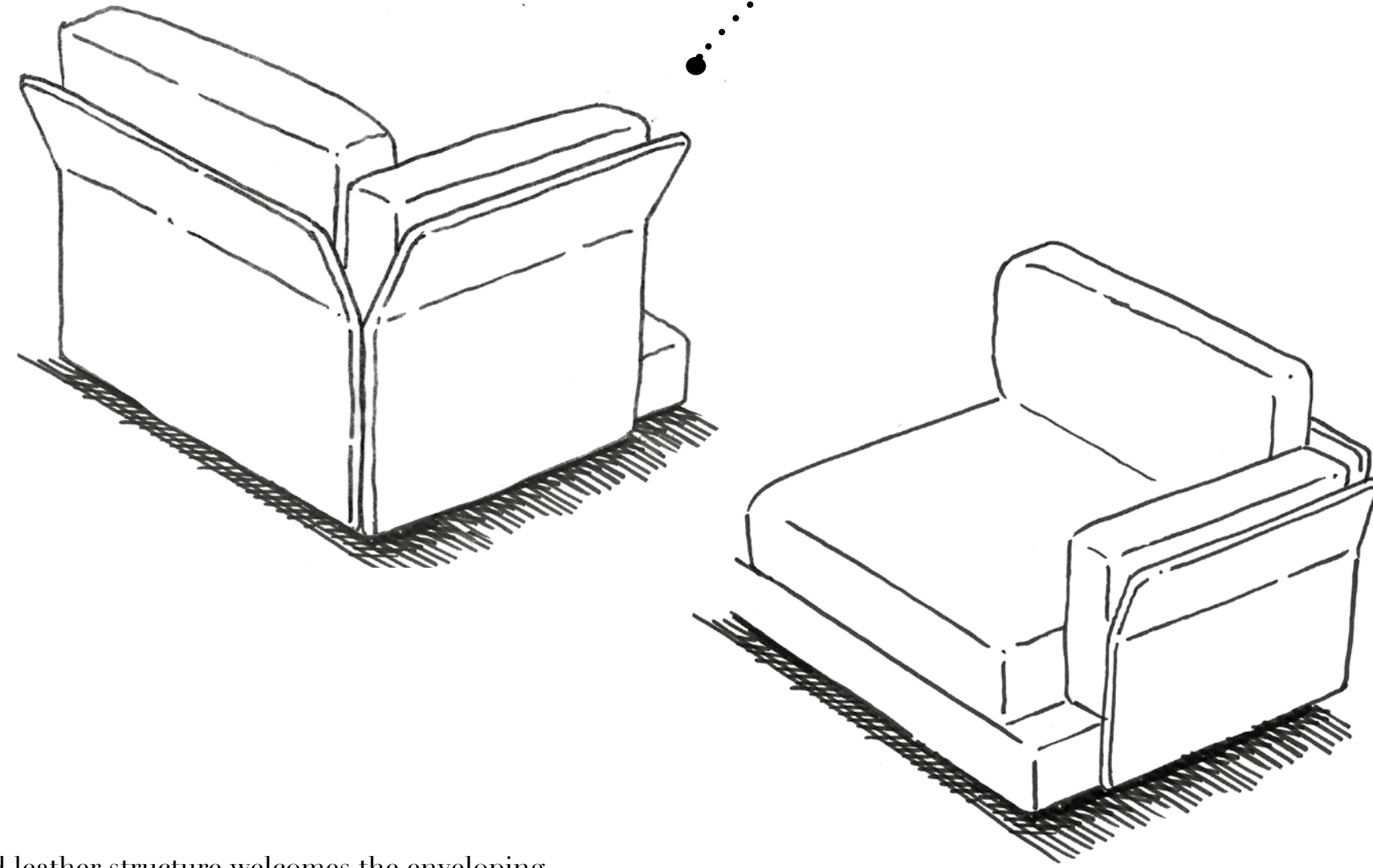

The rigid leather structure welcomes the enveloping seat, the contemporary design of the *Groovy* sofa is made for complete relaxation.

La rigida struttura in pelle o tessuto accoglie l'avvolgente seduta, il design contemporaneo del divano *Groovy* è al servizio del relax più totale.



Groovy

Composition 2

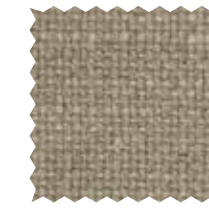
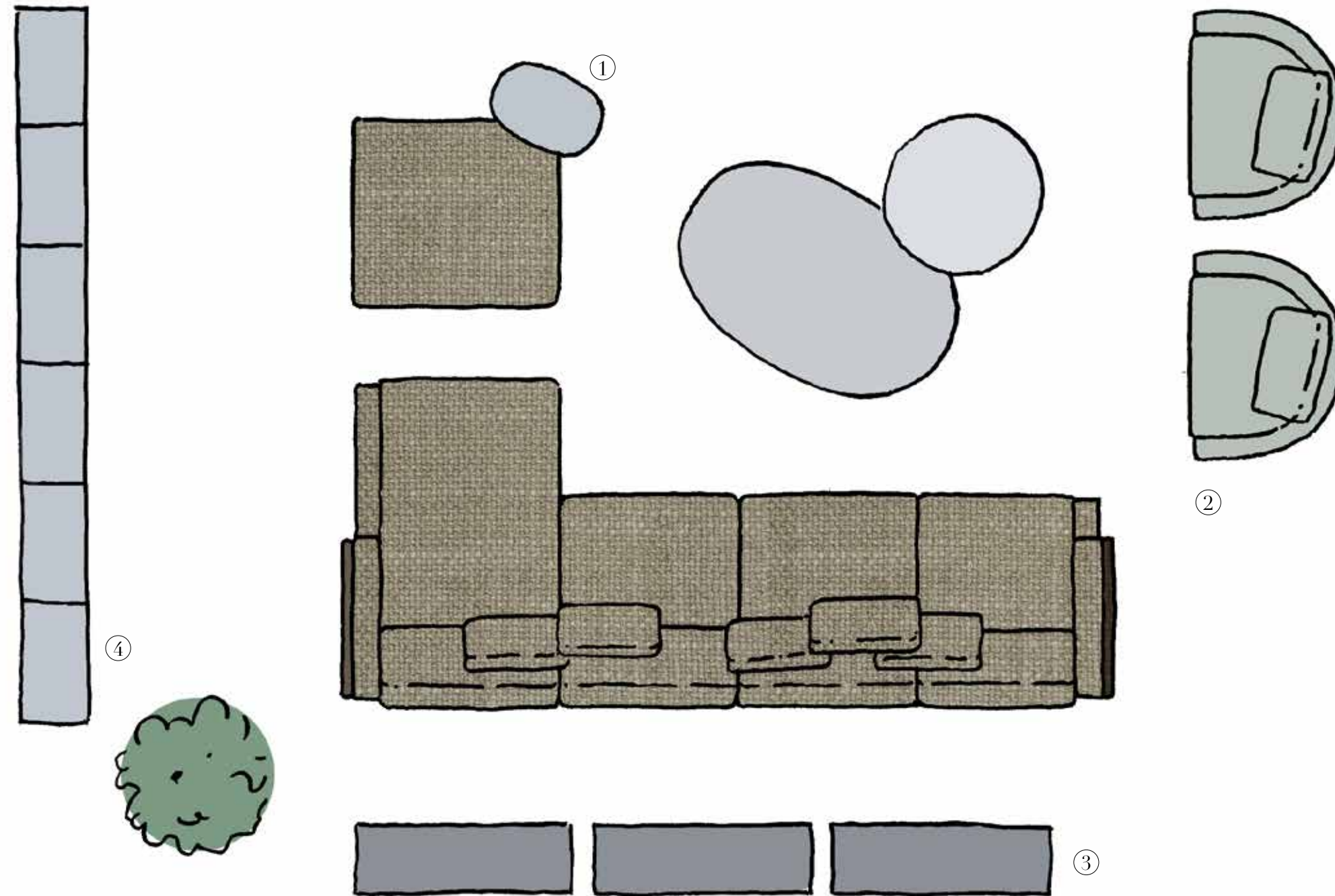

Sofa Fabric – Tessuto Divano

1- Fabric, Tessuto Nyda – TDC 71 22

2- Leather, Pelle Top – PT 0011

Proutcs – Prodotti

1- Ortis, Coffee Table, Tavolino

Little Oval, Ovale piccolo: Lcl Agave 243

Oval, Ovale: Lcl Nocciola 213

Round, Tondo: Heat-treated oak, Rovere termotrattato

2- Alton, Armchair, Poltrona

Fabric, Tessuto Virgo TDE 852

3- LT40 Frame, Storage System

Lcl Agave 243, Walnut L, Noce L

4- Selecta, Modular system

Walnut L, NoceL

Groovy

Composition 2



Groovy

Composition 2



Groovy

Abacus

Sofas - Divani
H. 790 - 31"
P. 950 - D. 37¼"

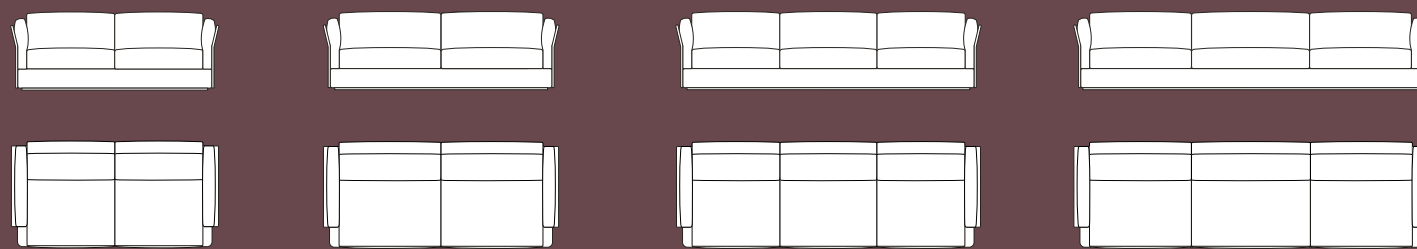

1860 - 73¼"

2100 - 82¾"

2740 - 102¼"

3100 - 122"



950 - 37¼"

End unit
Elementi terminali

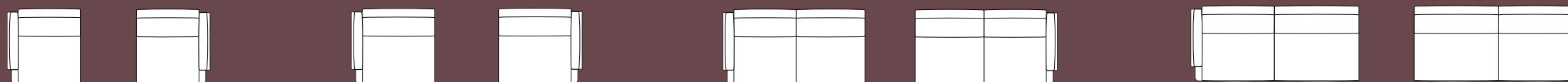

SX
930 - 36½"

DX
930 - 36½"

SX
1050 - 41¾"

DX
1050 - 41¾"

SX
1810 - 71¼"

DX
1810 - 71¼"

SX
2050 - 80¾"

DX
2050 - 80¾"

Central unit
Elementi centrali

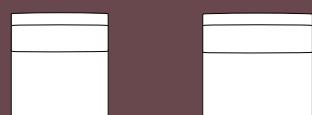

880 - 34½"

1000 - 39¼"

Corner unit
Elementi angolari

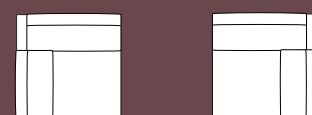

SX
950 - 37¼"

DX
950 - 37¼"

End dormeuse
Dormeuse terminali
P. 1530 - D. 60¼"



1050 - 41¾"

1050 - 41¾"

Central dormeuse
Dormeuse centrale
P. 1530 - D. 60¼"



1000 - 39¼"

Pouf
P. 900 - 35½"



1000 - 39¼"

Square pouf
Pouf quadrato
P. 900 - 35½"



900 - 35½"

Essential lines and a strong character: the *Ombra* stool, the latest addition to the namesake seating collection designed by Piero Lissoni, is essentially light but solid in function. *Ombra* is composed by a metal structure with minimal lines that supports the thin shell proposed in polypropylene or entirely covered in leather with lightweight padding. Available in two different heights, making it versatile and easy to fit in a home, yet especially designed for the contract area, it is an ideal solution for restaurants, bars and lounge areas. The introduction of white and red between the finishes in the catalog brings again in prominence the extreme versatility and customisation possible with the *Ombra* collection. Indeed, different types of colours are available for the structures that can match or contrast with the tones of the leather upholstery. As for the version in propylene, structure and shell will each maintain a uniformity of colour.

Linee essenziali e carattere deciso: lo sgabello *Ombra*, ultima novità dell'omonima collezione di sedute firmata da Piero Lissoni, si presenta leggero alla vista ma solido nella funzione. *Ombra* è composto da una struttura in metallo dai tratti minimali che sostiene la sottile scocca proposta in polipropilene oppure interamente rivestita in pelle con leggerissima imbottitura. Disponibile in due altezze si distingue per il forte carattere industriale e un'innata leggerezza che lo rendono versatile e facile da inserire in ambito domestico, ma pensato soprattutto per l'area contract, come soluzione ideale per ristoranti, bar e aree conviviali. L'introduzione del bianco e del rosso tra le finiture a catalogo porta nuovamente in risalto l'alta versatilità e personalizzazione della collezione *Ombra*. Sono infatti disponibili per le strutture diverse tipologie di colore che potranno combaciare o andare in contrasto con i toni del rivestimento in pelle. Per quanto riguarda invece la versione in propilene, struttura e scocca manterranno un'uniformità di colore.

OMBRA FAMILY
PIERO LISSONI
→ **LEMA 2022**

Ombra

Chair



Ombra

Chair



Ombra



Stool



Ombra

Stool



Ombra

Stool



Ombra

Abacus

Chair - Sedia
H. 770 - 30¼"
P. 550 - 21¾"

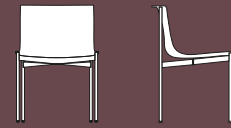

550 - 21¾"

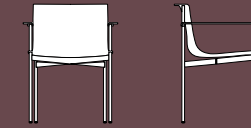

615 - 24¼"

Stool - Sgabello
H. 1005 - 39½"
P. 550 - 21¾"

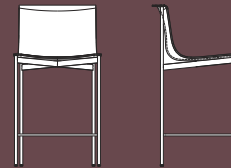

550 - 21¾"

Stool - Sgabello
H. 1115 - 43¼"
P. 550 - 21¾"

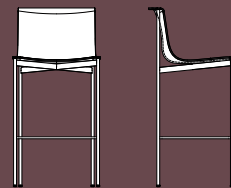

550 - 21¾"

Stool with armrest
Sgabello braccioli
H. 1005 - 39½"
P. 550 - 21¾"

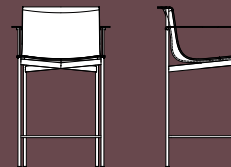

615 - 24¼"

Stool with armrest
Sgabello braccioli
H. 1115 - 43¼"
P. 550 - 21¾"

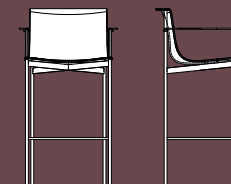

615 - 24¼"