

Modular system

# SELECTA



# SELECTA

Modular system

# SELECTA

LEIVA



# INDEX

1. Introduction — 6
2. The families — 8  
Examples — 10
3. Compositions — 14  
Living Rooms — 16  
Dining Rooms — 46  
Studio, Bookcases — 64  
Service Areas — 104  
Made to measure solutions — 126
4. Assemblages — 90  
Technical index — 152
5. Technical sheet — 154
6. Samples collection — 168

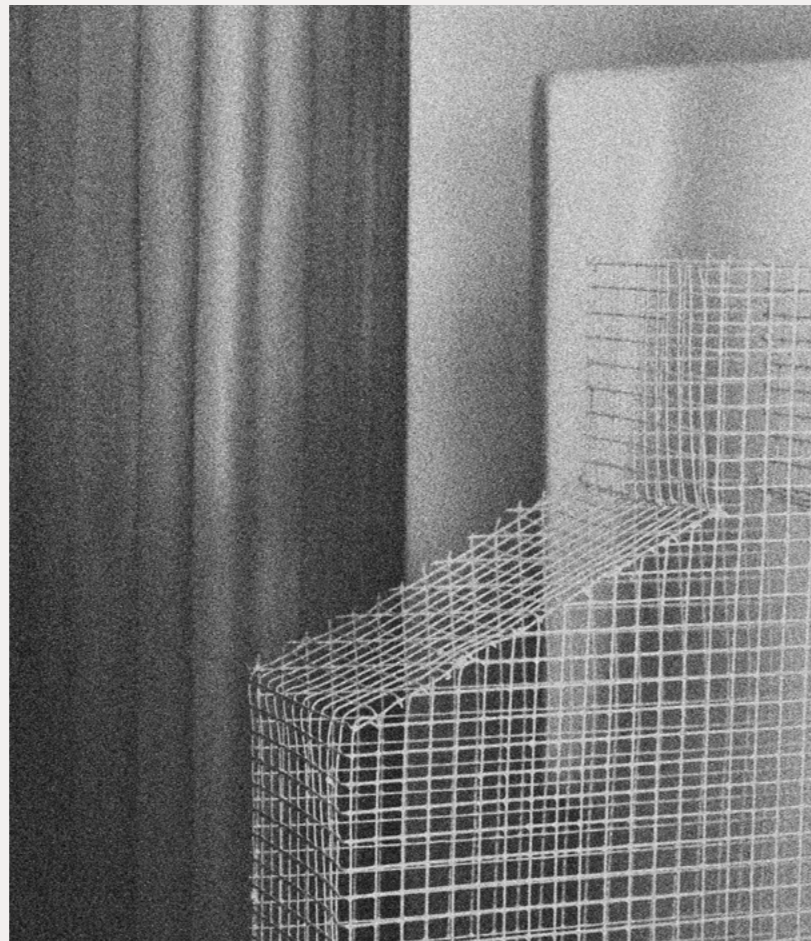

# 1.

## INTRODUCTION

Architettura in scala per oggetti e pensieri. Dal 1995 Selecta è espressione di una progettualità libera, non soggetta a schemi e vincoli. Su misura e flessibile nell'estetica e nella funzione si declina in infinite composizioni come ritmiche scansioni sulle pareti, pensate per contenere ed esporre.

Architecture of scale for objects and thoughts. Since 1995 Selecta has been an expression of free planning, not subject to schemes and constraints. Tailored and flexible in aesthetics and function, it is expressed in infinite compositions such as rhythmic scans on the walls, designed to contain and exhibit.

Sistema in costante evoluzione, capace di svilupparsi nello spazio con il rigore di una geometria perfetta e la creatività di una struttura libera da vincoli dimensionali. Selecta abita la casa con eleganza, naturalezza, intelligenza. La modularità dei suoi elementi consente lo sviluppo di composizioni su misura. La ricchezza e la qualità delle finiture ne fanno la scelta ideale in ogni ambiente, sia esso classico o contemporaneo, residenziale e non. Librerie, pareti attrezzate per l'intrattenimento, lo studio e il lavoro, setti divisori, composizioni a giorno o con vani chiusi per spazi di servizio e di passaggio, soluzioni a doppia altezza per mansarde e sottoscale. Gioco di pieni e vuoti altamente personalizzabile, Selecta è capace di adeguarsi a ogni nuova esigenza funzionale ed estetica.

Constantly evolving system, capable of developing in space with the rigour of perfect geometry and the creativity of a structure free from dimensional constraints. Selecta inhabits the house with elegance, naturalness, intelligence. The modularity of its elements allows the development of custom compositions. The richness and quality of the finishing make it the ideal choice in any environment, classic or contemporary, residential or not. Bookcases, walls equipped for entertainment, study and work, dividing partitions, open compositions or with closed compartments for service and passage spaces, double height solutions for attics and stairwell units. A highly customizable game of full and empty spaces, Selecta is capable of adapting to any new functional and aesthetic requirement.

## 2. THE FAMILIES

Selecta, per versatilità e modularità si adatta ad ogni spazio risolvendo anche le problematiche architettoniche più complesse. Una libertà progettuale unica che si riflette nella ricchezza e qualità delle finiture.

For versatility and modularity, Selecta adapts to any space, solving even the most complex architectural problems. A unique design freedom that is reflected in the richness and quality of the finishing.

Sistema modulare su misura, Selecta assicura risposte stilistiche e funzionali per soluzioni d'arredo sartoriali. Espressione di un modo di progettare tutto italiano orientato alla sostanza intesa come eccellenza dell'esecuzione e dei materiali. Punti di forza ne sono infatti la flessibilità e l'evoluta tecnologia costruttiva garantita dalla produzione industriale su misura di serie insieme all'alta qualità e alla ricchezza di materiali. Legni, laccati lucidi e opachi, argille, vetri: la personalizzazione è totale anche nelle finiture.

Tailored modular system, Selecta ensures stylistic and functional answers for tailored furnishing solutions. Expression of an all-Italian way of design oriented towards substance as the excellence of execution and materials. Strengths are in fact the flexibility and the advanced construction technology guaranteed by the standard customized industrial production together with the high quality and richness of materials. Woods, glossy and matt lacquers, clays, glass: the personalization is total even in the finishing.

# Examples

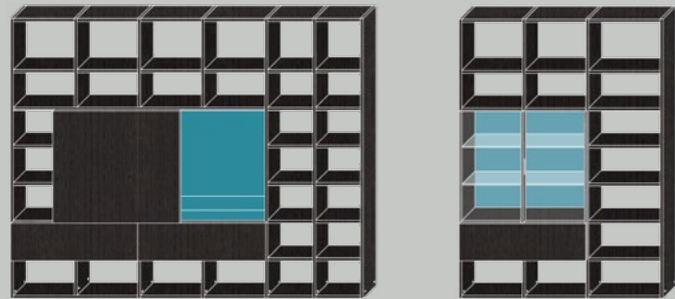

01.

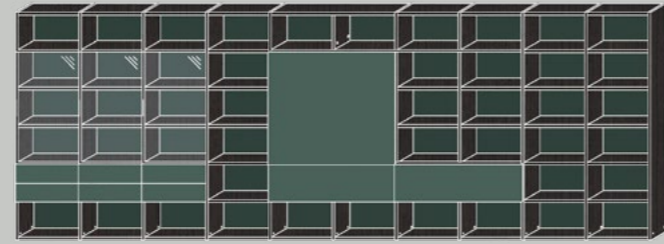

02.

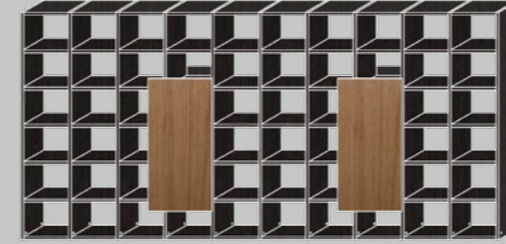

07.

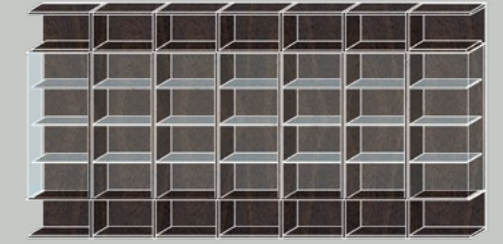

08.



03.

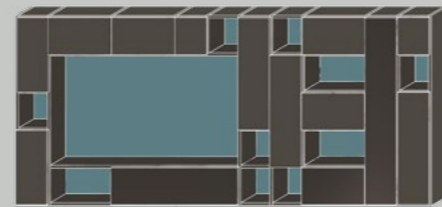

04.

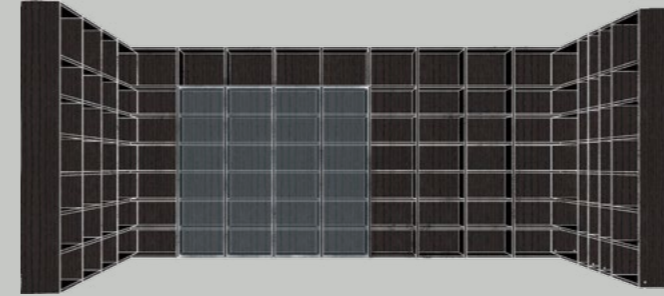

09.

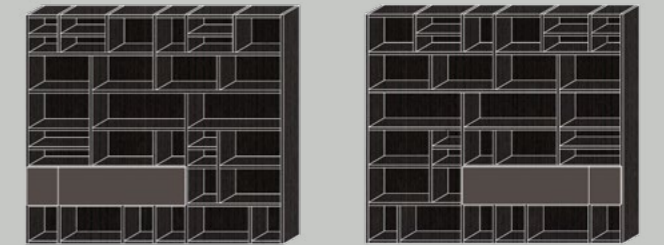

10.

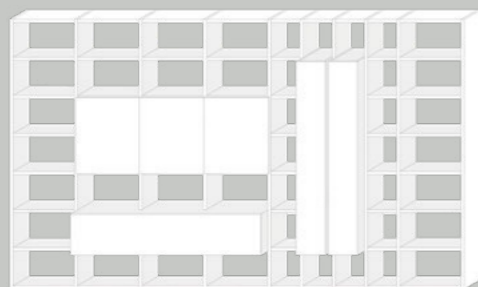

05.



06.

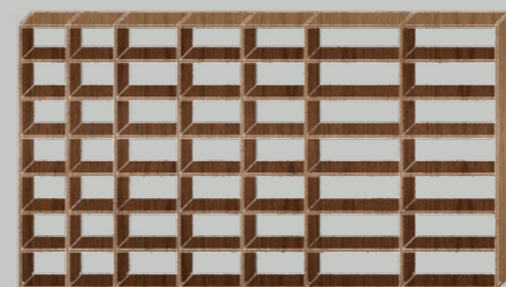

11.

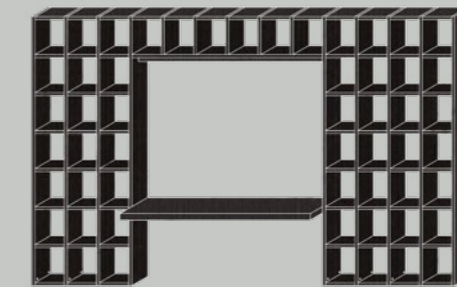

12.

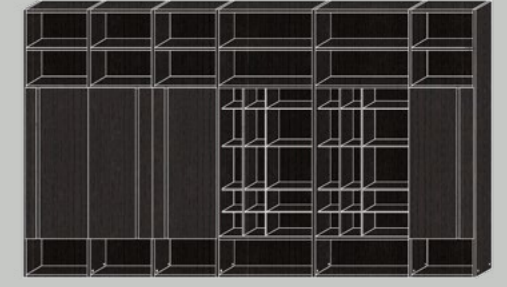

13.

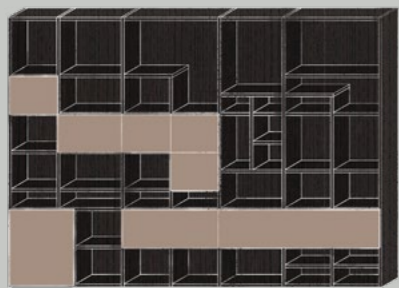

14.

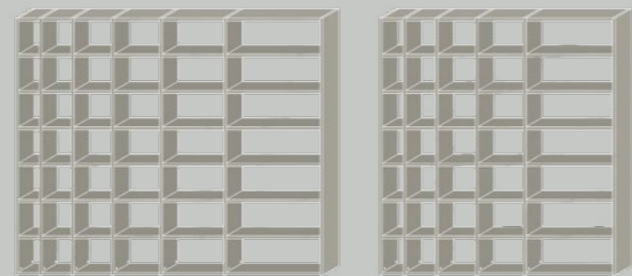

15.

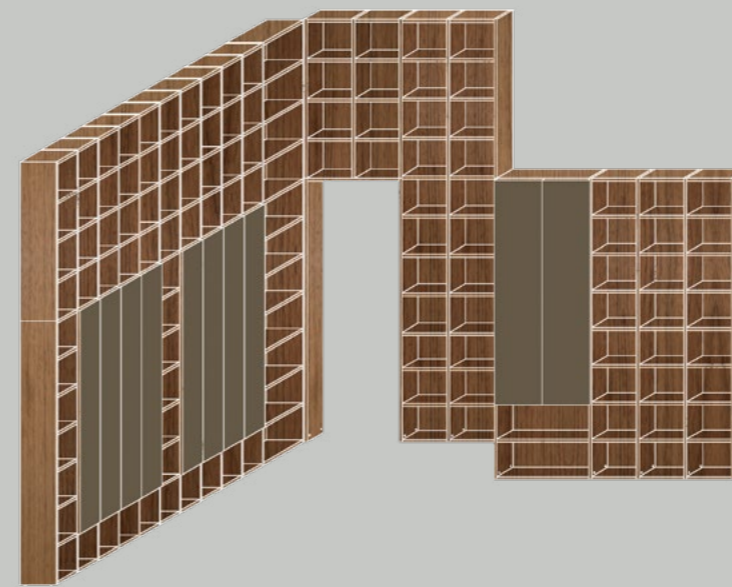

20.

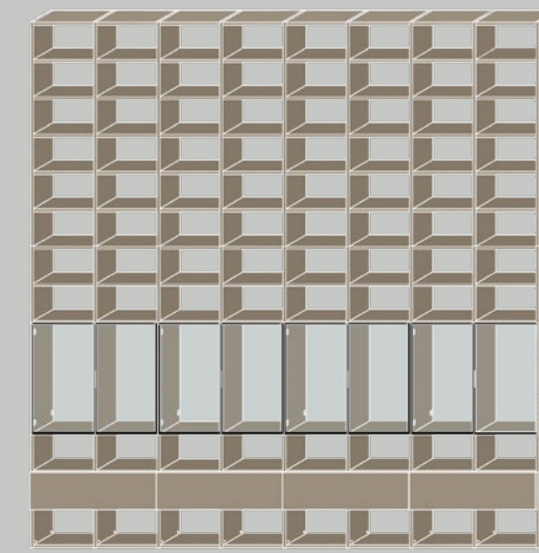

21.



16.

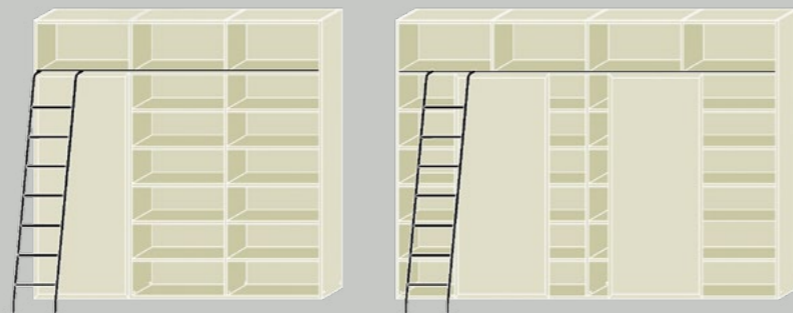

17.

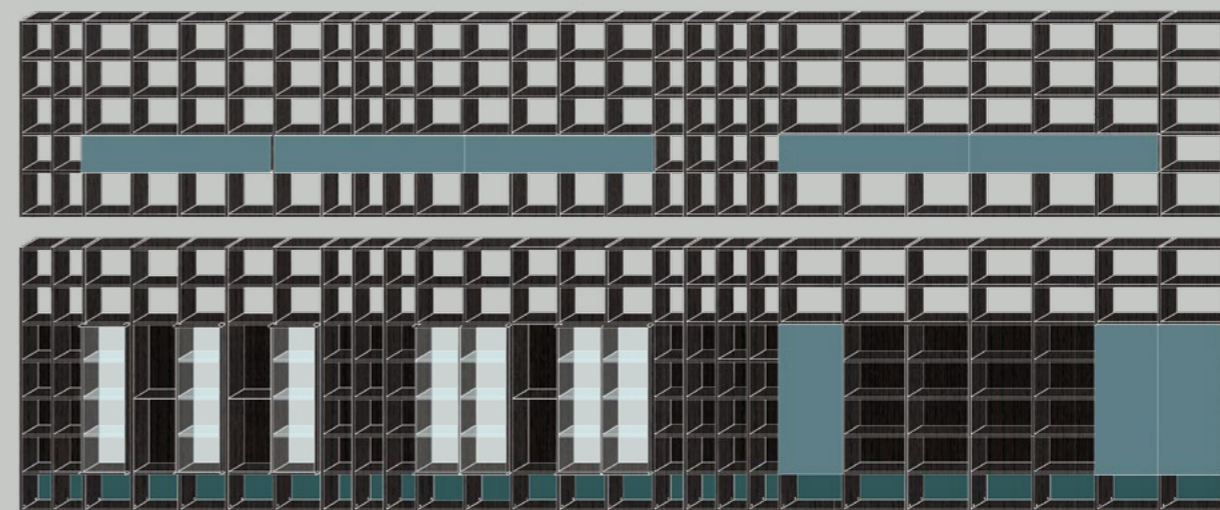

22.



18.

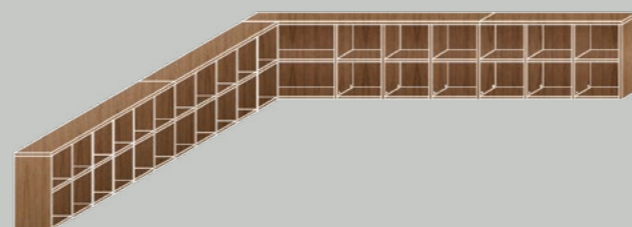

19.

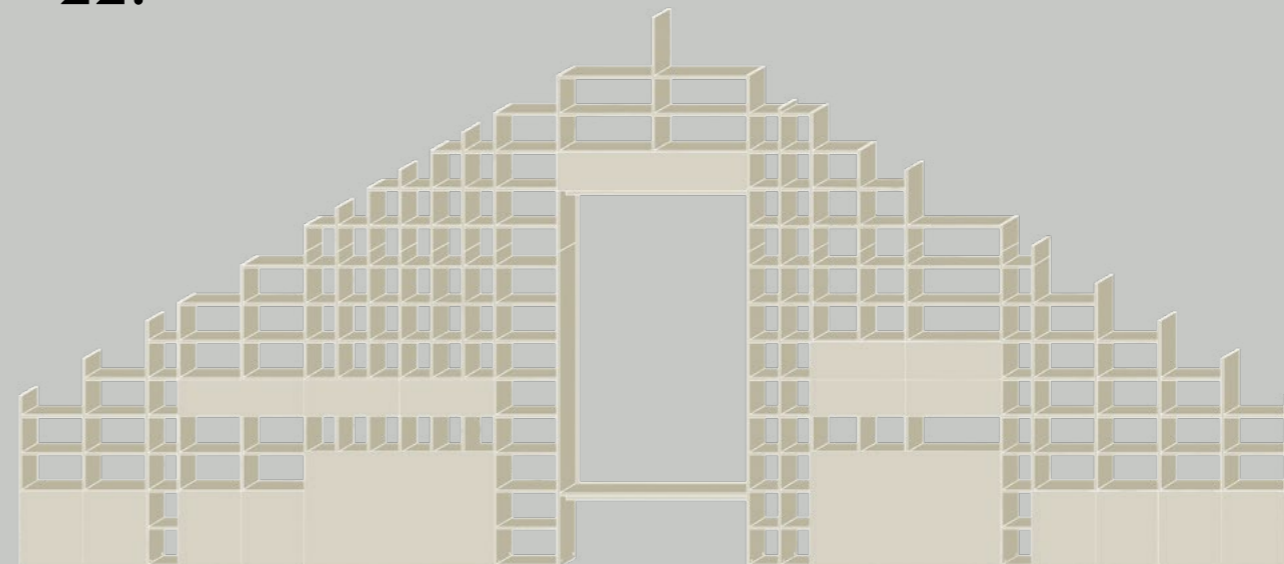

23.



# 3. COMPOSITIONS

Una griglia architettonica pensata come una tela bianca da dipingere, da sviluppare sulla base di esigenze funzionali ed estetiche personali. Il su misura di serie di Lema trova in Selecta massima espressione.

An architectonic grid thought up as a white canvas to paint, to develop based on functional needs and personal aesthetics. In Selecta, the standard made-to-measure finds its greatest expression.

Con oltre 1500 elementi a catalogo, tutti altamente personalizzabili, in numerose versioni e finiture, le possibilità compositive di Selecta sono praticamente infinite. Dalla libreria nella sua forma più classica con vani a giorno si può trasformare grazie alle numerose ante del programma – battenti, a ribalta o scorrevoli – per creare colonne con vani chiusi e cassette. Funzione ed estetica concretizzano così le esigenze più personali, senza limiti e schemi progettuali. Continui gli sviluppi sul programma che propone ancora elementi terminali a giorno e ante a filo e aggettanti, anche doppie e angolari. Per chi cerca una libreria capace di accogliere le proprie collezioni, Selecta propone vani con fondali in velluto e ripiani in vetro, una soluzione che trasforma la libreria in una quinta dal fascino seducente dove esporre gli oggetti più preziosi mentre i ripiani in legno retroilluminati a LED assicurano un effetto soffuso a tutto l'ambiente.

With more than 1500 elements available as per catalogue, all highly flexible, in many versions and finishing, the possible compositions of Selecta are limitless. From the most classical bookcase with open units it can easily transform thanks to the numerous doors of the system – hinged/ protruding hinged doors, flap or sliding doors – in order to create columns with closed units and drawers. Function and appearance realize then the most personal needs, without limits and design schemes. Constant developments on the system that still proposes open ending units and flush doors and protruding doors, both double and corner doors. For those looking for a bookcase able to accommodate their collections, Selecta proposes niches with velvet back panels and glass shelves, a solution capable to transform the bookcase into a scenery flat of seductive charm where the most precious objects can be displayed, while the LED backlit wooden shelves offer a suffused effect to the whole room.

# LIVING ROOMS

Grazie alle tecnologie e alle soluzioni disponibili, Selecta è ideale per progettare composizioni che alloggiano tv e hi-fi, vere e proprie pareti multifunzione in grado di soddisfare gli appassionati più esigenti, anche dal punto di vista del design. La ricerca Lema mira, da sempre, a offrire sistemi all'avanguardia sia per estetica sia per tecnologia.

Thanks to the technologies and solutions available, Selecta is ideal for designing compositions containing the TV and audio systems, real multifunctional walls able to satisfy the most exacting enthusiast, also from a design standpoint. The Lema research always aims to offer systems that are cutting-edge, both aesthetically and technologically.





Divano, Sofa **Neil**  
Tavolino, Coffee table **Sign**

Tavolino, Coffee table **Oydo**  
Poltrona, Armchair **Fantino**

Selecta separa gli spazi e definisce le loro funzioni: da un lato il mobile tv crea un confortevole ambiente living; dall'altro, la biblioteca invita allo studio e al lavoro. I vani a giorno lasciano filtrare la luce, che raggiunge anche gli angoli più nascosti. Libreria con struttura rovere Carbone, fondali laccati Lct verde Petrolio, ante battenti vetro trasparente con profilo metallo anodizzato nero. Tv, lettore DVD, decoder, etc, non sono più visibili grazie ad elementi che nascondono i vani dedicati con ante scorrevoli e a ribalta.

Selecta separates the spaces and defines their functions: on the one hand the TV unit creates a comfortable living environment, while the bookcase is an encouragement to study and work. The open units let bookcase with Carbone oak structure, Petrol green Lct lacquered back panels, transparent glass hinged doors with black anodized metal profile. TV, dvd player, decoder, etc., are no longer visible thanks to elements that hide the inside of the relevant units with sliding and drop-down doors.





Struttura rovere Carbone, fondali laccati Lct verde Petrolio, ante battenti vetro trasparente con profilo metallo anodizzato bronzo.

Bookcase with Carbone oak structure, Petrolio green Lct lacquered back panels, transparent glass hinged doors with black anodized metal profile.





Divano, Sofa Yard  
Tavolino, Coffee table Cruise  
Mobile retrodivano, Back sofa cabinet Court yard

Selecta è protagonista della zona living con una grande composizione pensata per accogliere libri, oggetti, ricordi. I contenitori con ante a vetro e i cassetti si alternano ai vani a giorno. Al centro il vano tv con ante scorrevole e vano passacavi celato alla vista dal fondale in legno. La struttura è in rovere Carbone, l'anta scorrevole e quelle a ribalta dei cassetti sono in laccato lucido color Ruta mentre le ante battenti sono in vetro trasparente con profilo in metallo anodizzato nero.

Selecta is the protagonist of the living area with a large composition designed to keep books, objects, memories. Units with glass doors and drawers alternate with open compartments. In the middle, the TV compartment with sliding door and cable compartment concealed from view by the wooden back panel. The structure is in Carbone oak, the sliding door and the flap doors of the drawers are in Ruta glossy lacquered while the hinged doors are in transparent glass with black anodized metal profile.



Divano, Sofa **Yard**  
 Tavolino, Coffee table **Sign**  
 Tavolino, Coffee table **Mansion**  
 Pouf **Notch**

L'anta a ribalta in laccato lucido color Ruta con apertura a pressione svela un vano con mensola, ideale per riporre telecomandi e impianti multimediali. La cura del dettaglio di Lema si evidenzia nel cavetto in acciaio che permette l'apertura dell'anta e negli interni in rovere Carbone come la struttura.

The flap door Ruta glossy lacquered with push/pull opening reveals a unit with shelf, which is ideal for the accommodation of remote controls and multimedia devices. The Lema's attention to details is recognisable in the steel cable that allows the door's opening and in the inside finishing in Carbone oak same as the structure.







Una composizione a parete, in legno rovere Carbone e laccato grigio Fumo, crea un'interessante alternanza di volumi, dando vita a una nuova interpretazione di spalla portante.

A wall composition in Carbone oak wood lacquered Fumo grey creates an interesting alternation of volumes, resulting in a new interpretation of load-bearing side panels.

Divano, Sofa Snap  
Tavolino, Coffee table Mansion

La tv è alloggiata in un ampio vano incassato, perfettamente integrato con il resto della facciata. Un'alternativa più classica e calda è offerta dalla facciata interamente in legno.

The TV is housed in a large recessed unit and integrates perfectly with the rest of the front. A more classic and warmer alternative is offered with the front entirely in wood.





Dettaglio del passacavi sul piano di appoggio per la tv, non appesa, ma appoggiata sulla propria base. A destra, facciata in versione con ante in rovere Carbone.

Detail of the cable ducting on the TV stand, which does not hang but rests on its own base. Right, the front in the version with Carbone oak doors.





Dotata di ampio vano tv, questa composizione Selecta alterna elementi a giorno e chiusi, ante di spessore normale e maxi, il mélange della finitura lucida Alga a quella opaca Fango. I vani a giorno hanno il fondo color Avio.

Equipped with a large TV unit, this Selecta composition alternates open and closed elements with normal and extra-thick doors, and a mix of gloss Alga and matt Fango finishes. The color Avio is chosen for the rear of the units.

Tavolino, Coffee table **Flowers**  
Pouf, **Pouf**

In questo dettaglio proponiamo un'alternativa che include coppia di cassetti nella versione a maxi spessore.

In this detail we present an alternative that includes a pair of drawers in the extra-thick version.





Una composizione pensata come parete attrezzata per la zona pranzo. I vani chiusi hanno diverse profondità e sono studiati per organizzare al meglio gli spazi dedicati al contenimento. Una soluzione esteticamente lieve, grazie alla struttura in bianco opaco con ante bianco lucido.

A composition created as a fitted wall for the dining area. The closed sections have different depths and are designed for optimal organization of storage spaces. A solution that is aesthetically light thanks to the structure in matt white with gloss white doors.

Poltrona, Armchair Wing

Le ante battenti aggettanti  
in laccato lucido bianco  
conferiscono movimento  
alla composizione in laccato  
bianco opaco creando volumi  
chiusi con mensole dove  
riporre piatti, bicchieri e altri  
oggetti.

The protruding hinged doors  
in white glossy lacquered  
give a movement to the  
composition in white matt  
lacquered, creating closed  
units with shelves for placing  
plates, glasses and other  
objects.





Dettaglio del vano orizzontale aggettante, chiuso da anta a ribalta con apertura a cavetto in acciaio e illuminazione a sensore ad apertura d'anta. Lo spazio interno è organizzato con cassetto e vani con ripiani in cristallo. Tutte le facciate, eccetto la ribalta, prive di maniglia, sono dotate di apertura a pressione.



Detail of the horizontal projecting unit, closed by drop-down doors with steel cable and lighting that is sensor-activated when door is opened. The interior space is organized with a drawer and units with glass shelves. All the fronts, except for the drop down door, are free of handles and equipped with a push opening mechanism.



# DINING ROOMS

Nella fluidità delle case contemporanee, anche nella zona dining come in cucina, spazi designati alla convivialità e alle relazioni più intime, Selecta con l'unicità del suo segno arreda e delimita gli ambienti con soluzioni su misura. Pareti attrezzate, altamente personalizzabili scandiscono le diverse zone, separando le funzioni in un gioco di volumi aperti e chiusi, di chiari e scuri.

In the fluidity of contemporary homes, even in the dining area as in the kitchen, spaces designed for conviviality and more intimate relationships, Selecta with the uniqueness of its sign furnishes and delimits rooms with tailor-made solutions. Equipped, highly customizable walls scan the different areas, separating the functions in a game of open and closed volumes, of light and dark.





Tavolo, Table **Memo**  
Sedia, Chair **Bai Lu**



La grande composizione che arreda la zona dining sceglie il carattere sofisticato delle ante in vetro retrolaccato color Titanio con profilo in metallo anodizzato nero. Raffinata eleganza anche nei dettagli: i cassetti hanno facciate in laccato opaco senza maniglie mentre scelgono per gli interni la finitura in melaminico Stone, esclusiva di Lema.

The great composition furnishing the dining room is featured by the sophisticated character of the back lacquered glass doors in Titanium colour with black anodized metal profile. Refined elegance in details too: drawers have matt lacquered fronts without handles, and for the inside the Stone melamine finish, exclusive only for Lema.



Tavolo, Table **Jump**  
Poltroncina, Armchair **Hati**



Spazio fluido, da un lato la grande cucina, dall'altro il living e la zona pranzo. A dividere gli ambienti e definirne le funzioni la grande composizione bifronte di Selecta che abbina alla struttura a giorno in rovere Carbone speciali ante battenti su misura, quasi come quadri sospesi, nell'intensa finitura noce L a contrasto.

Fluid space, on one side the great kitchen, on the other one the living and the dining room. To separate the rooms and define the functions, the big double-faced Selecta composition combines the open structure in Carbone oak with special custom hinged doors – almost like hanged paintings – in the intense finishing L-walnut that creates contrast.

Rovere Carbone e noce L,  
il dialogo tra le due essenze  
a contrasto definisce il carat-  
tere sofisticato di questa  
cucina. La struttura a giorno  
scura sostiene le ante su  
misura con punto di battuta  
fuori modulo.

Carbone oak and L-walnut,  
the sophisticated dialogue  
between the two woods in  
contrast that defines the  
sophisticated character of  
the kitchen space. The dark  
open structure underlines the  
protruding hinged doors.





La luminosità dell'ambiente si specchia in questa sofisticata composizione di Selecta definita dalle trasparenze delle ante in vetro aggettanti Glance con profilo in metallo bronzo che alleggeriscono la struttura in rovere Carbone donando intensi riflessi. La purezza del vetro trasparente extra-chiaro caratterizza anche i terminali con ante ad angolo e i ripiani interni in cristallo.

The brightness of the room reflects itself in this sophisticated Selecta composition defined by the transparency of the protruding glass doors Glance with black anodized metal profile, which lighten the structure in Carbone oak giving intense reflects. The purity of the extra-clear glass characterises also the ending units with corner doors and internal glass shelves.



Tavolo, Table Graceland  
Sedia, Chair Bea

Bergère Lady Jane  
Tavolino, Coffee table Mr Zheng





Il profilo in metallo anodizzato nero come la cornice di un quadro definisce la raffinata essenza di questa composizione caratterizzata dalla trasparenza delle ante aggettanti ad angolo in vetro extra chiaro Glance con ripiani interni in cristallo extra light.



The black anodized metal profile like the frame of a painting defines the refined essence of this composition characterized by the transparency of the projecting corner doors in glass Glance with internal shelves in extra light glass.

# STUDIO, BOOKCASES

Una libreria è una vera e propria architettura, una casa per oggetti e pensieri, scoperte e memorie capaci di dare anima allo spazio, di rendere dinamiche le pareti, trasformandole in una scansione ritmica creata per ordinare. Nelle prossime pagine, Selecta è proposta in diverse composizioni libreria pensate per adeguarsi funzionalmente alle esigenze domestiche, ma anche alle qualità degli ambienti, valorizzandone gli aspetti più interessanti.

A bookcase is in reality a piece of architecture, a home for objects and thoughts, discoveries and memories able to give a soul to the space and to render the walls dynamic, transforming them into a scene of rhythmic orderliness. On the following pages, Selecta is presented in a variety of bookcase compositions designed to adapt functionally both to the needs of the domestic environment and to the quality of the surroundings, enhancing its most interesting aspects.





Una grande libreria a "C" in rovere Carbone, con soluzioni ad angolo, che alterna vani a giorno e parti chiuse da eleganti ante in vetro trasparente di diverse misure con telaio in alluminio anodizzato bronzo.

A large C-shaped bookcase in Carbone oak with corner systems alternates open shelving with units enclosed by elegant clear glass doors of different sizes with bronze anodized aluminum framing.

Divano, Sofa **Aberdeen**  
Tavolino, Coffee table **Cruise**



Dettaglio dell'anta in vetro trasparente con telaio in alluminio anodizzato bronzo. All'interno, i vani hanno ripiani in cristallo extra light e sono illuminati da lampada led incassata nel coperchio.

Detail of the door in clear glass with bronze anodized aluminum framing. Inside, the units have extra-light glass shelves and are illuminated by LED lighting recessed into the top.





Due librerie Selecta si fronteggiano, utilizzate come elementi divisori d'ambiente: la struttura è in rovere Carbone, con ante a ribalta e battenti laccate Grigio lucido. speculari, le due librerie si caratterizzano per il movimento che delimita gli spazi dei vani a giorno in un gioco estetico e funzionale di forme, dimensioni e altezze diverse.

Two Selecta bookcases facing each other, used as room dividing elements: the structure is in Carbone oak, with flap and hinged doors glossy lacquered in colour Grigio. Symmetrical, the two bookcases are featured by the movement that marks of the open units spaces in an aesthetic and functional game of forms, dimensions and different heights.

Consolle, Console Victoria



Al movimento geometrico dei volumi a giorno si contrappongono i contenitori chiusi dalle raffinate ante battenti in laccato grigio lucido con apertura a pressione.

To contrast the geometrical movement of the open units there are the units closed by refined hinged doors glossy lacquered in Grigio colour with push/pull opening.



Poltrona, Armchair **Taiki**  
Contenitore a isola, Free standing unit **Faroe**



La grande libreria bifronte a tutta altezza sceglie il calore della finitura noce L, raffinata interpretazione del noce Canaletto trattato secondo una gradazione cromatica calda e contemporanea, esclusiva di Lema.



The large double-faced full-height bookcase chooses the warmth of the L-walnut finishing, a refined interpretation of Canaletto walnut treated according to a warm and contemporary colour gradation, exclusive to Lema.





Selecta offre la possibilità di realizzare soluzioni home office su misura. Questa composizione in rovere Carbone combina ai vani a giorno un grande piano scrittoio di importante spessore.

Selecta offers the possibility to realize customized home office solutions. This Carbone oak composition combines a large, extra-thick writing desk with the open units.

Tavolino, Coffee table **Flowers**  
Tavolino, Coffee table **Cruise**



Il valore della qualità industriale su misura di Selecta si evidenzia nel rinforzo centrale della struttura a ponte che sostiene il ripiano superiore.

The value of the industrial made-to-measure quality of Selecta is underlined by the central reinforcement of the bridge structure that bears the upper shelf.



Il piano sporgente dal forte spessore trasforma Selecta in una soluzione ideale per organizzare uno spazio lavoro all'interno dell'ambiente domestico.

The jutting-out shelf of great thickness transforms Selecta in an ideal solution to organize the working space inside our homes.





La progettualità libera e senza schemi di Selecta permette di arricchire la struttura a giorno in rovere Carbone con le ante a gola in rovere Termotrattato dell'Armadio al Centimetro Naica. Al centro, la griglia in legno dagli spessori ridotti amplifica i vani di contenimento dando movimento al rigore geometrico della composizione.

The free planning ability without schemes offered by Selecta allows to enrich the open structure in Carbone oak with grooved handle doors Naica in Heat-treated oak from Armadio al Centimetro. In the centre, the wooden grid with reduced thickness amplifies the units giving movement to the geometrical rigour of the composition.



La disposizione irregolare dei ripiani di questa composizione Selecta crea interessanti geometrie nel gioco fra pieni e vuoti. Ogni combinazione può, di volta in volta, essere personalizzata secondo le diverse esigenze. La struttura è in rovere Carbone con ante a ribalta e battenti lucide color Nocciola e opache color Ombra.

The irregular arrangement of shelves of this Selecta composition creates an interesting geometry in a play between solids and voids. Each combination may be changed and customized according to different requirements. The structure is in Carbone oak with drop-down and side-hinged doors in the colors gloss Nocciola and matt Ombra.





Il ritmo irregolare dei ripiani fuori asse definisce l'estetica e le funzioni di questa grande libreria su misura in rovere Carbone. Un nuovo racconto delle potenzialità del sistema Selecta.

The irregular rhythm of the misaligned shelves defines the aesthetics and the function of this great custom bookcase in Carbone oak. A new way to tell the potentialities of Selecta system.



# 4.

## ASSEMBLAGES

Il dialogo tra forma e materiali sta al piacere tattile come la cura certosina dei dettagli sta all'eleganza firmata Lema.

Legni, marmi, metalli. Rovere Carbone, noce L, argilla. E ancora cristallo, bronzo. Un inventario di materiali la cui fisicità affascina la creatività, promuove accostamenti e diversità. L'assemblage di Lema è un'operazione di ricerca inclusiva che tende a sintetizzare l'eleganza con un effetto estetico mai scontato. Osare inediti accostamenti di materie prime per sperimentare nuove manufatti secondo un'idea di progetto frutto della filosofia di Lema.

Wood, marble and metal have special Lema finishes called Carbone oak, L-walnut, clay – all are combined with glass and bronze. The inventory of materials was carefully selected to fascinate the creative eye, to promote interesting combinations of diverse textures. Combinatory studies are an all-round line of research at Lema, aimed at encapsulating elegance with a novel aesthetic effect. The audacious juxtaposition of different raw materials goes hand in hand with experimentation in new types of manufacturing along the lines of the design thinking at Lema.

At Lema, the dialogue between shapes and materials is an indispensable part of tactile pleasure. Just as meticulously crafted details are an active ingredient of elegance.

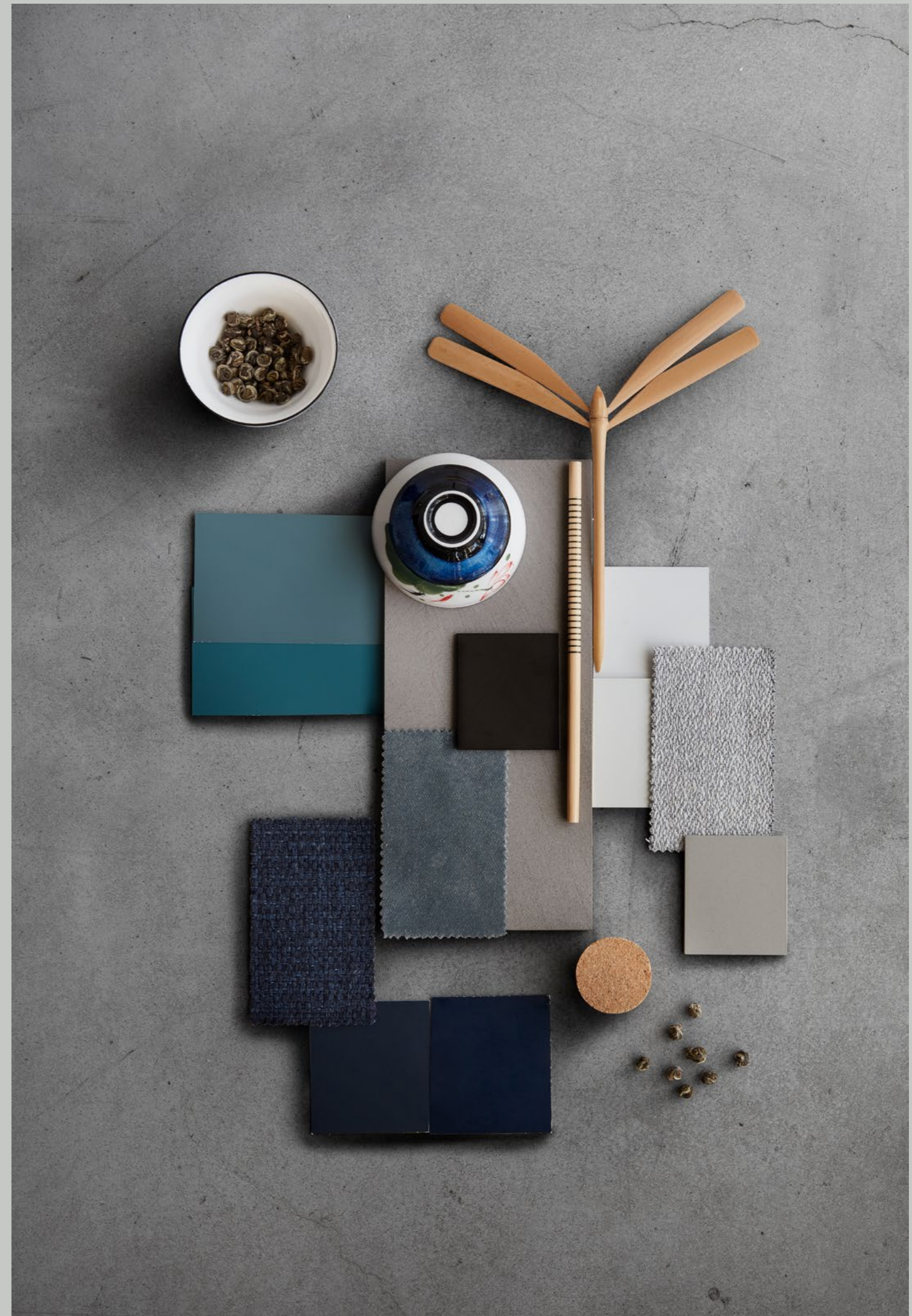
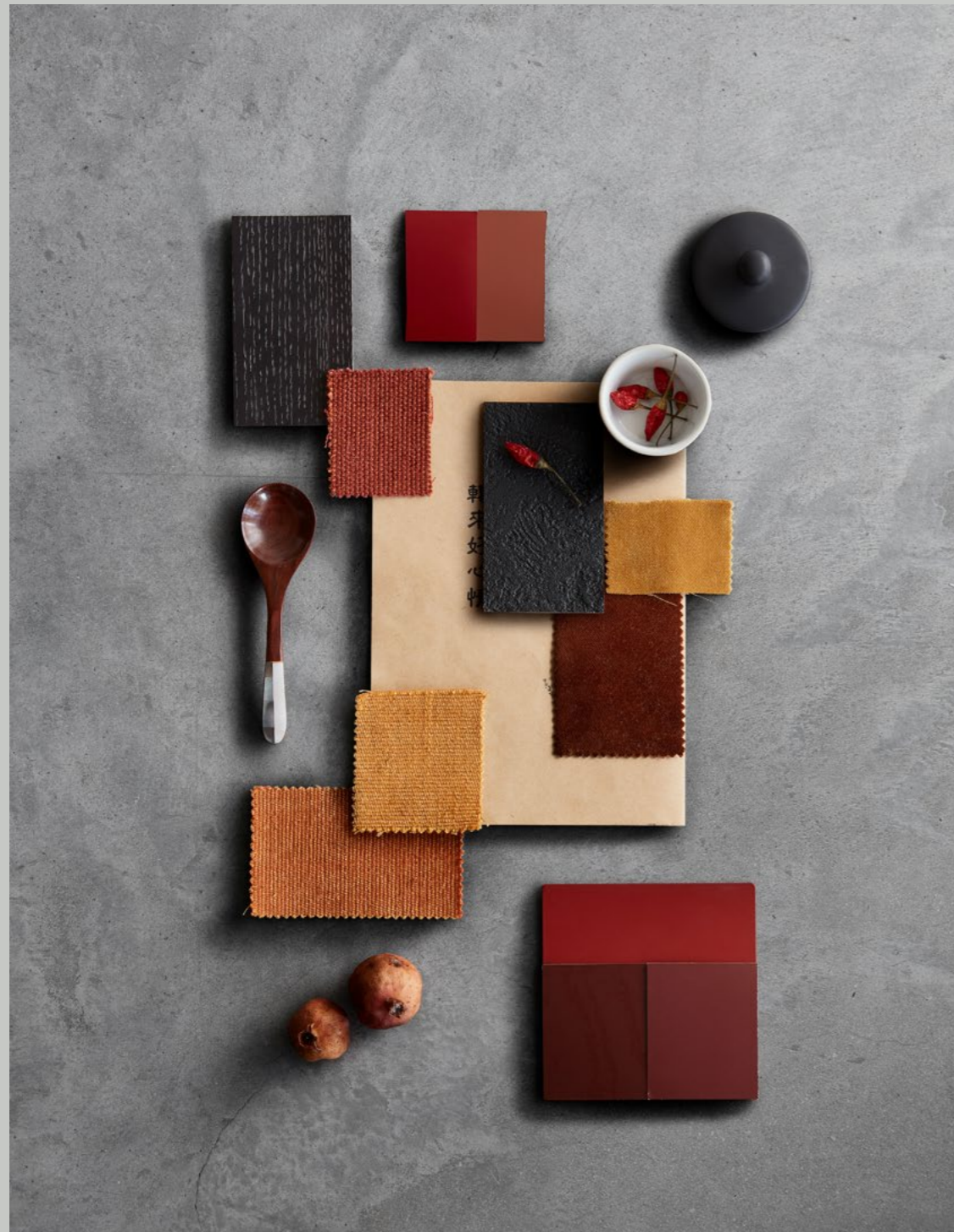



# Assemblage 1+2

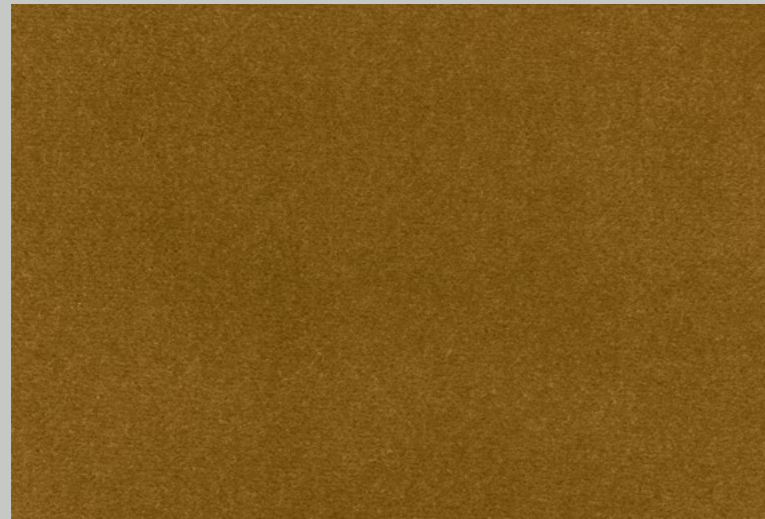

Chara TDE 770



Argilla Polvere  
Polvere Clay

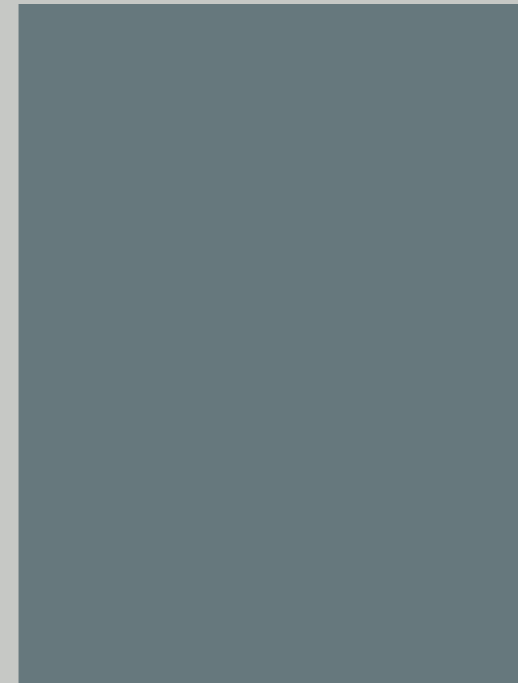

LCT Avio 476



Noce L  
L-walnut



LCL Granata 238



LCL Persia 241

# Assemblage 1+2

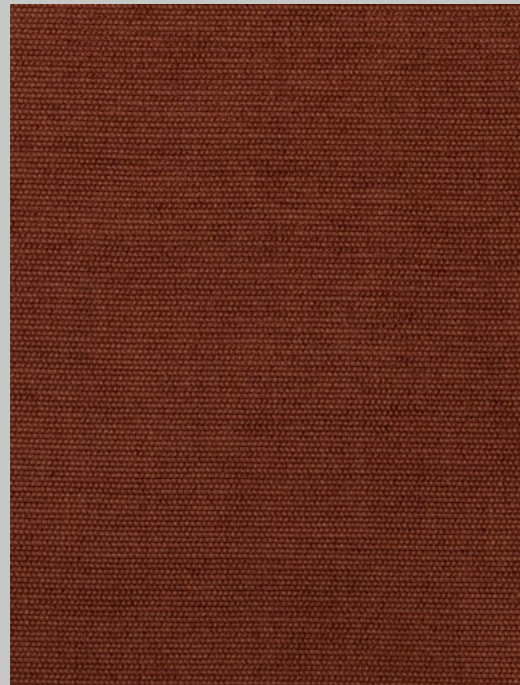

Fenice TDD 864

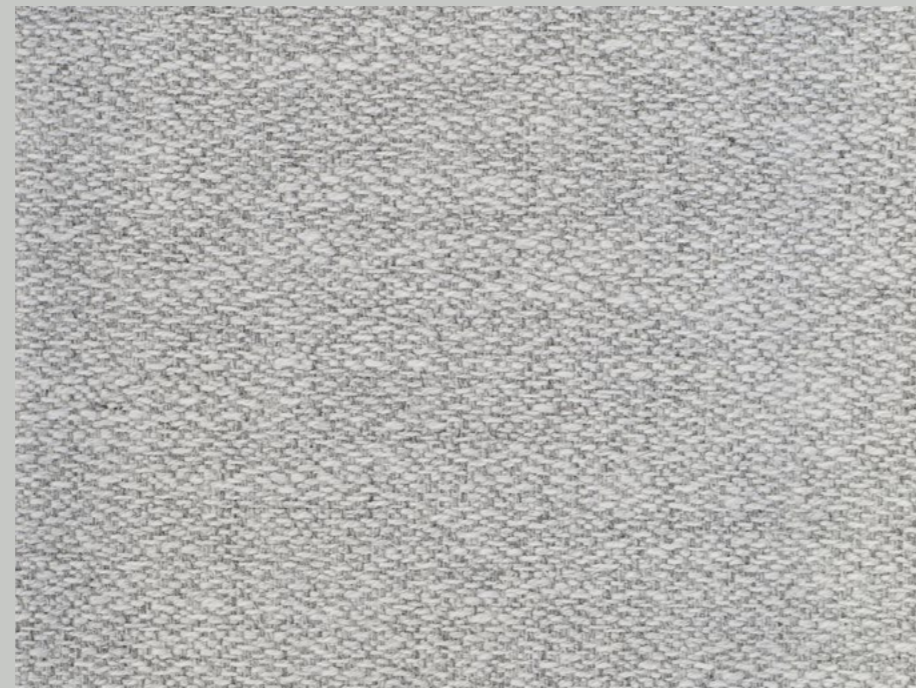

Choo TDC 790



LCT Amarena 828



Kuma TDD 190

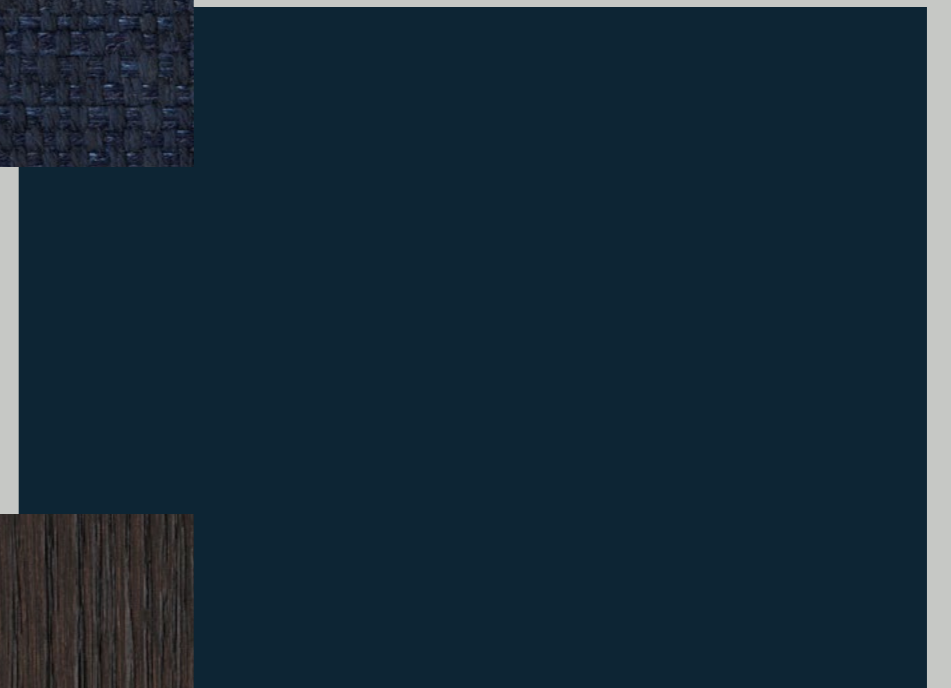

LCL Danubio 242



Rovere Carbone  
Carbone oak

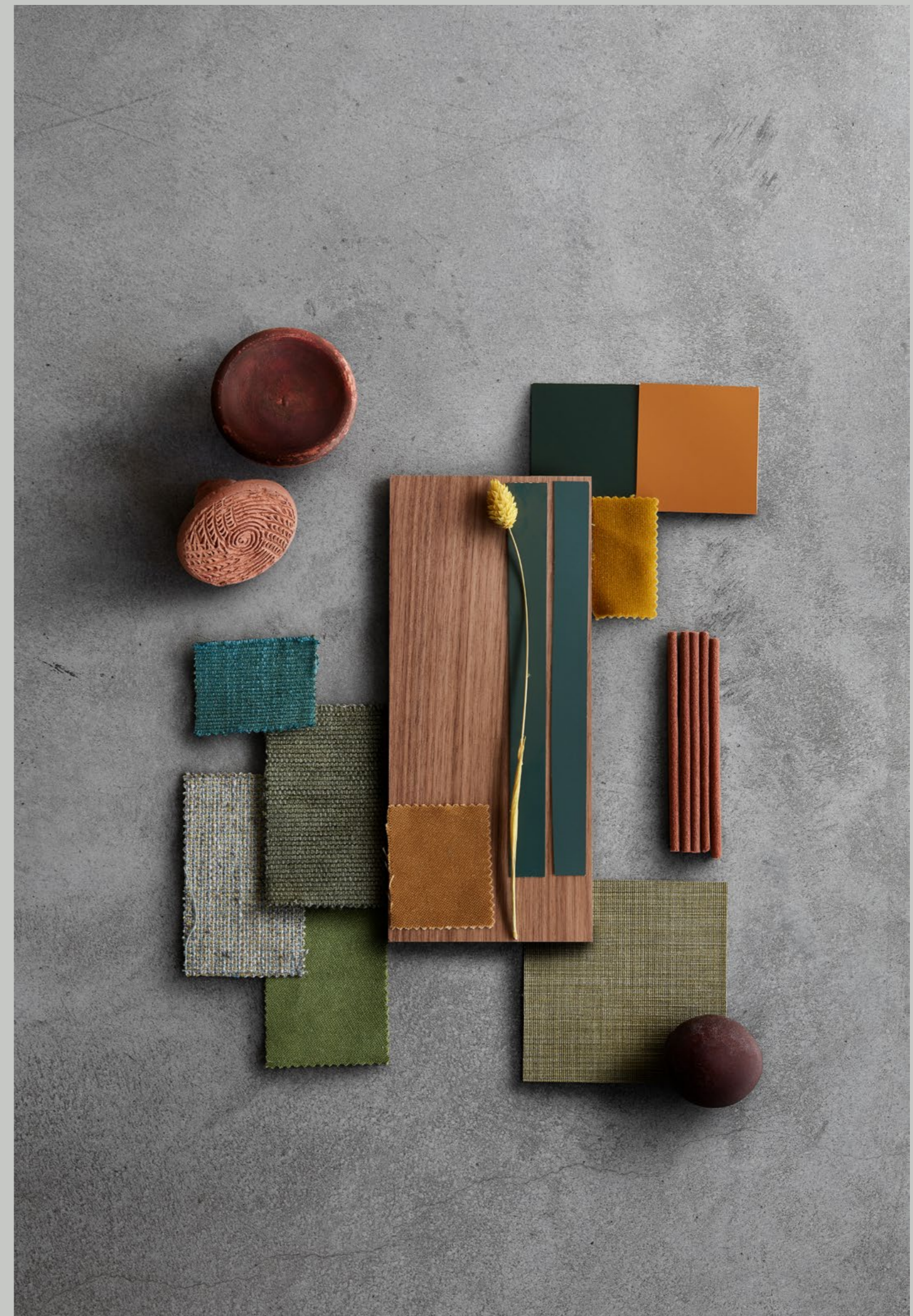

# Assemblage 3+4



Vetro Aragosta  
Aragosta glass

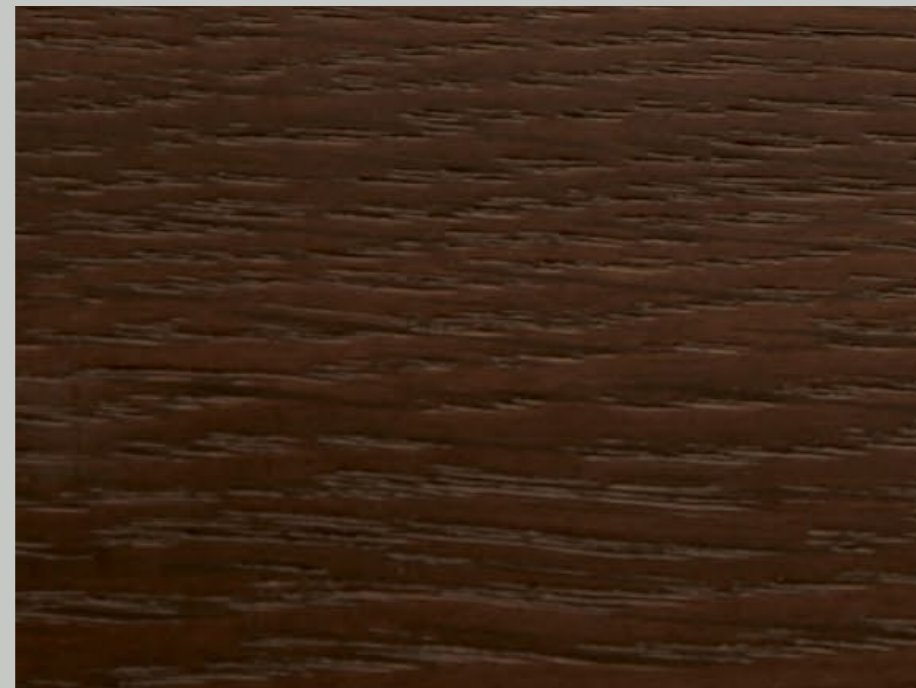

Rovere termotrattato  
Heat-treated oak



LCL Grigio 205



LCL Alga 222



LCT Terracotta 478



Phobos TDC 469

# Assemblage 3+4



LCT Bruciato 477

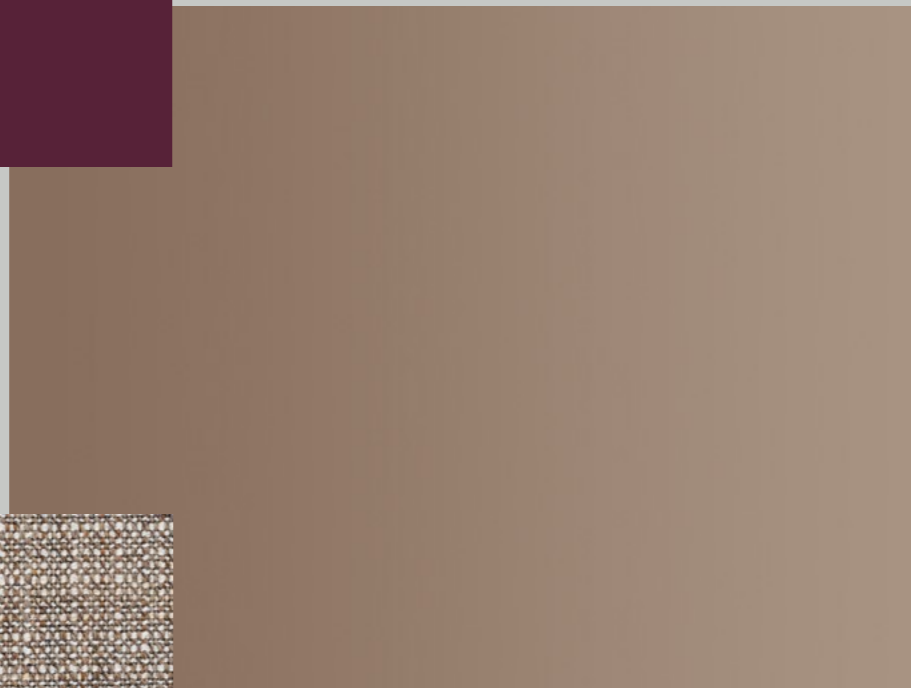

Vetro bronzo riflettente  
Bronze reflective glass



Dorado TDD 875



Metallo anodizzato nero  
Anodized black metal



LCT Curry 922



Cassiopea TDC 132

# SERVICE AREAS

Zone di servizio, spazi di passaggio, ambienti intermedi, sottotetti, aree prossime a scale: Selecta, per la sua versatilità e l'ampia gamma di finiture, misure e moduli in cui è disponibile, si adatta a qualsiasi tipo di utilizzo all'interno della casa. Cura e attenzione ai dettagli fanno di ogni composizione una presenza di raffinato design, in grado di sottolineare la qualità dello spazio domestico.

Service areas, passageways, intervening spaces, attics, areas close to stairs: due to its versatility and the wide range of finishes, sizes and forms available, Selecta is suitable for any type of use within the home. Care and attention to detail make each composition a piece of refined design, able to emphasize the quality of the domestic space.





Due composizioni a giorno in laccato opaco color Antimonio, dedicate a biblioteca. I vani di diverse misure in larghezza consentono di coprire l'intera dimensione dello spazio disponibile. Entrambe le composizioni mostrano una soluzione a misura sia in altezza sia in larghezza, a raggiungimento delle misure delle pareti.



Two open bookcase compositions in the color matt Antimonio. The units of different widths can cover the entire area of available space. Both compositions illustrate a solution that has been customized in both height and width to the respond to the dimensions of the walls.

Una rigorosa composizione in laccato opaco e rovere Carbone, dotata di vani a giorno e chiusi, fa di un ambiente di servizio, come un lungo corridoio, uno spazio ordinato e accogliente.

This rather austere composition in mat lacquered and Carbone oak with open and closed shelving, makes a service environment, such as a long corridor, a tidy and welcoming space.







La grande libreria con struttura in laccato opaco si arricchisce di vani con ante a ribalta e cassetti in rovere Carbone, senza maniglie con aperture a pressione. La cura del dettaglio di Lema si racconta nelle discrete cerniere in lega metallica bronzata.



The great bookcase with matt lacquered structure is enhanced by units with flap door and drawers in Carbone oak, without handle and with push/pull opening. The attention to the detail of Lema is expressed by the discreet hinges in bronzed metal.

Selecta arreda anche gli spazi di servizio come questa zona lavanderia con una grande composizione a tutta altezza con struttura in laccato opaco. Le ante scorrevoli arricchiscono la proposta aumentando la funzionalità. Perfetto l'abbinamento con l'Armadio al Centimetro Dandy, altra perfetta espressione del suo misura di serie di Lema.

Selecta is capable to furnish also service spaces like this laundry room with a big composition at full height and matt lacquered structure. The sliding doors enrich the proposal increasing its functionality. Perfect combination with Dandy door from Armadio al Centimetro, which is a perfect expression of the Lema made-to-measure.



Tavolo, Table Filo  
Pouf Notch



Raffinatezza formale e funzionalità dialogano in questa composizione dove le ante scorrevoli e la scala a pioli scorrono sul binario in metallo integrato nella struttura.

Formal refinement and functionality converse in this composition where the sliding doors and the ladder slide on the metal rail integrated into the structure.





Una composizione a vetrina i cui ripiani, tramite sensore, si illuminano ad apertura di ante. L'alta qualità del sistema Selecta fa di un mobile di servizio, collocato in una zona di passaggio fra pranzo e soggiorno, un arredo di elegante design.

A showcase composition where the shelves are illuminated when the doors are opened. The high quality of the Selecta system makes a service unit, located in a passageway between the dining and living room, a piece of decor of elegant design.

Poltrona, Armchair Popsi



Dettaglio dei ripiani in vetro opalino, delle ante con telaio in metallo anodizzato nero e vetri trasparenti extra light. Le cerniere, a marchio Lema, sono in lega metallica bronzata.

Detail of the opal glass shelves, the doors with black anodized metal framing and extra-light clear glass. The Lema brand hinges are bronze metal alloy.



Dettaglio dei ripiani luminosi con accensione a sensore ad apertura di anta. La maniglia è incassata nel telaio della vetrina, in metallo anodizzato bronzo.

Detail of the luminous shelves that light up when the door is opened. The handle is recessed into the frame of the showcase, in bronze anodized metal.



Sotto la grande vetrata,  
a segnare la lunghezza  
del vano scala, la libreria  
angolare bassa corre lungo  
la parete. L'intensa finitura  
in noce L della struttura a  
giorno riscalda l'ambiente.

Below the great glass window,  
to mark the length of the  
stairwell, the low corner  
bookcase covers the whole  
wall. The intense finish in  
L-walnut of the open  
structure warms the room up.





# MADE TO MEASURE SOLUTIONS

Doppie altezze, mansarde, larghezze e altezze non standard... spesso gli spazi domestici presentano situazioni architettoniche complesse. Grazie alla versatilità strutturale che connota il suo progetto, il sistema Selecta risolve adeguatamente le più diverse problematiche di spazio attraverso soluzioni custom.

Double heights, attics, non-standard widths and heights... domestic spaces are often architecturally complex. Thanks to the structural versatility that characterizes the project, the Selecta system is able to address a wide range of spatial problems through the provision of custom solutions.





Divano, Sofa Jermyn  
Tavolino, Coffee table Cruise

La grande libreria angolare a doppia altezza realizzata su progetto scandisce e delimita gli spazi del raffinato living affacciato su grandi vetrate. La struttura geometrica con vani a giorno nella calda finitura in noce L è intervallata da vani chiusi da ante battenti in laccato opaco verde Assenzio.

The great corner bookcase with double heights realized on measures defines the spaces of the refined living room surrounded by great glass windows. The geometrical structure with open units in the warm finish L-walnut is interrupted by closed units with hinged doors matt lacquered in green colour Assenzio.

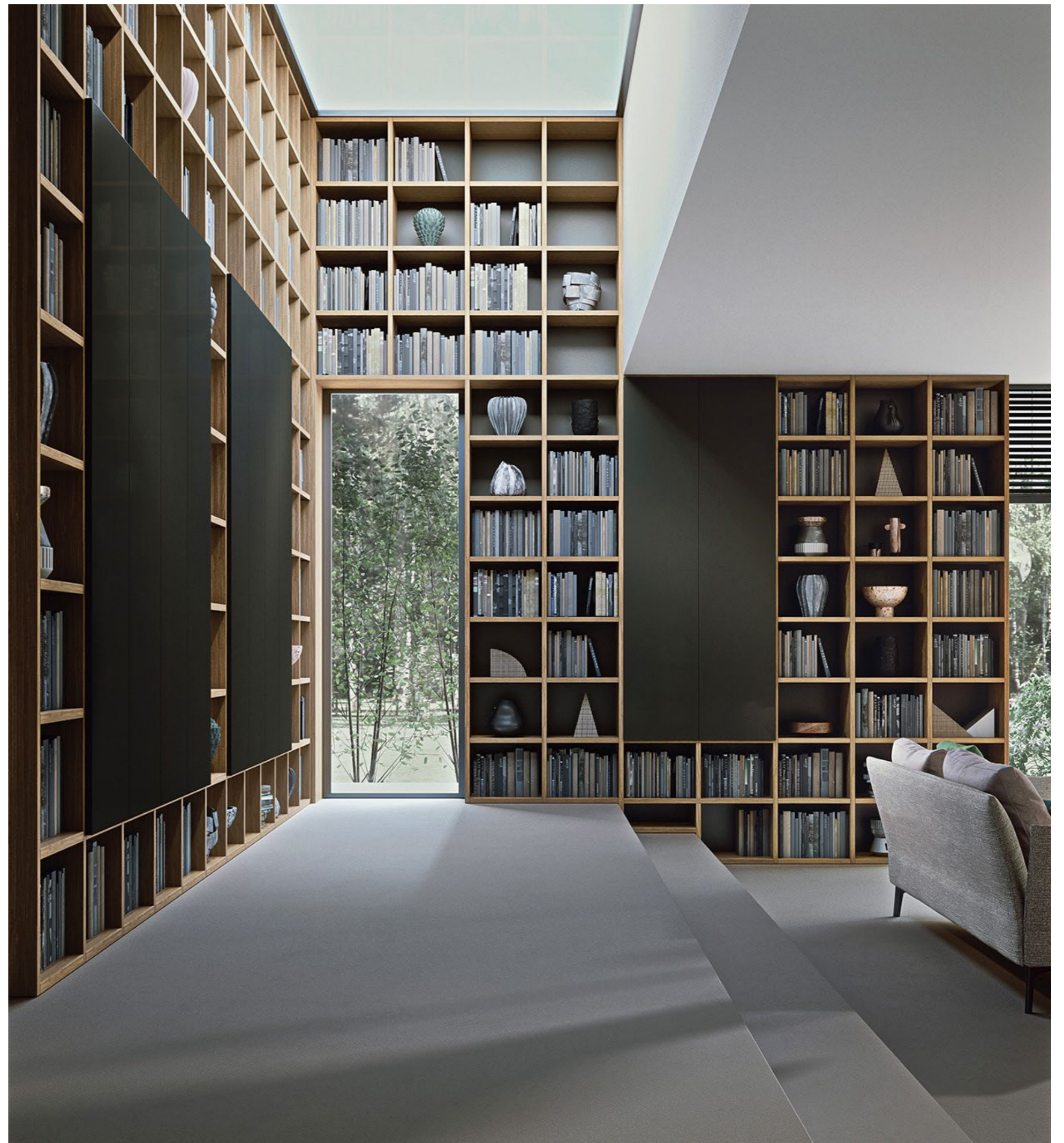



Un progetto su misura in ogni dettaglio: la libreria segue la forma delle pareti e si sviluppa a scala sui gradini che collegano i diversi livelli dell'ambiente.

A tailor-made project in every detail: the bookcase follows the shape of the walls and develops in a staircase on the steps that connect the different levels of the environment.



Il calore del legno della struttura e l'eleganza del laccato opaco verde Ruta delle ante battenti disegnano un armonico gioco di spessori e materiali. Aprendo le ante l'effetto continuità è assicurato dagli interni in noce L come la struttura.

The wood's warm of the structure and the elegance of the matt lacquered in green colour Ruta of the hinged doors create an harmonic game of thicknesses and materials. By opening the doors, the continuity is ensured by the internal elements in L-walnut as per the structure.



Divano, Sofa **Snap**  
Tavolino, Coffee table **Deck**

Storage system **LT40**  
Daybed **Yard**



Protagonista dell'ambiente, la libreria a doppia altezza bifronte sceglie l'eleganza del laccato opaco Pepe. I vani a giorno sono interrotti con ritmo geometrico da ante a ribalta nella stessa finitura della struttura e ante battenti in vetro trasparente con profilo in metallo anodizzato nero.

Protagonist of the environment, the double-height bookcase chooses the elegance of Pepe matt lacquer. The open units are interrupted with a geometric rhythm by flap doors in the same finishing as the structure and hinged doors in transparent glass with black anodized metal profile.



La sofisticata trasparenza delle ante battenti in vetro con profilo in metallo anodizzato nero caratterizza la grande libreria su misura bifronte, elemento architettonico che divide lo spazio custodendo libri, ricordi e oggetti preziosi.



The sophisticated transparency of the glass hinged doors with black anodized metal profile characterises the large double-faced tailored bookcase, an architectural element that divides the space by keeping books, memories and precious objects.

Nel grande ambiente a doppia altezza le due librerie su misura sovrapposte definiscono lo spazio con raffinato rigore. La struttura è in rovere Carbone mentre le ante battenti e a ribalta scelgono il laccato lucido verde Aneto e il vetro trasparente con profilo in metallo bronzo. Ricca e articolata nell'abbinamento dei diversi elementi che ne sottolineano il carattere sartoriale.

In the large double-height room, the two overlapping tailored bookcases define the space with refined rigour. The structure is in Carbone oak while the hinged and flap doors choose Aneto green glossy lacquer and transparent glass with black anodized metal profile. It is rich and articulated in the combination of the different elements that underline its tailoring character.



Divano, Sofa Yard  
Tavolino, Coffee table Oydo  
Poltrona, Armchair Alton





Al centro tra le ante aggettanti Glance in vetro trasparente con profilo in metallo anodizzato nero, la nicchia a giorno con rivestimento in velluto e ripiani in vetro diventa spazio elettivo dove esporre collezioni, ricordi e i propri oggetti più preziosi.



In the centre between the protruding Glance doors in transparent glass and black anodised metal profile, the open niche with velvet covering and glass shelves becomes an ideal space to display collections, memories and most precious objects.



La raffinata eleganza del rovere Carbone è enfatizzata dai ripiani in legno retroilluminati a led che donano una luce soffusa a tutto l'ambiente.

The refined elegance of Carbone oak is emphasised by LED backlit wooden shelves that give a suffused light to the whole room.



Nel grande ambiente sotto-tetto, il soffitto spiovente è enfatizzato dalla grande libreria, progetto su misura con taglio a mansarda in laccato opaco color Sabbia che ai vani a giorno abbina contenitori chiusi con ante battenti e a ribalta. Sviluppata su tutta la parete, la libreria offre appoggio per le testate dei letti e incornicia anche la finestra che diventa un quadro vivente, con rinforzi strutturali a ponte armato.

In the big attic, the sloping roof is emphasised by the great bookcase, custom designed with inclined cut in matt lacquered colour Sabbia combining open and closed units with hinged and flap doors. Developed along the entire wall, the bookcase offers accommodation to headboards, framing also the window, which becomes a living painting, with structural bridge reinforcements.



Il taglio a mansarda permette alla grande libreria su misura di assecondare il movimento della parete, sfruttando al meglio gli spazi. La finestra è incorniciata da essa. Per assicurare il miglior risultato funzionale ed estetico il davanzale e la volta superiore che sostiene un vano con anta a ribalta hanno rinforzi strutturali a ponte armato.

The sloped cut allows the custom bookcase to follow the movement of the wall, using at best the spaces. The window is framed by the bookcase. To ensure the best final functional and aesthetic result, the windowsill and the upper top that bears a unit with flap door have structural reinforcements.





La libreria su misura veste tutta la parete e grazie ai pannelli fissi funge anche da appoggio per le testate dei letti per una zona notte dal fascino unico. La struttura che incornicia la finestra disegna un davanzale con rinforzo armato che diventa piano d'appoggio e seduta dove abbandonarsi alla lettura.



The custom bookcase covers the entire wall and thanks to the fixed panels is capable to be a support for the headboards for a night room of a unique charm. The structure framing the window draws a windowsill with reinforcement bar that becomes a tabletop and a seat for a pleasant reading.

# TECHNICAL INDEX

Technical sheet — 154

Disegni tecnici, Technical drawings — 156

Composizioni, Compositions — 160

Samples collection — 168



# 5.

## TECHNICAL SHEET

Libreria per eccellenza, in continuo sviluppo, Selecta è estremamente versatile dal punto di vista delle composizioni, delle finiture e degli usi. Architetture domestiche libere da schemi e vincoli, su misura per ogni casa e funzione d'uso.

Grazie alla costante introduzione di nuove finiture ed elementi, Selecta si adatta all'evoluzione degli spazi abitativi. Su misura di serie, risponde ad ogni esigenza sia essa estetica o funzionale, in linea con le tendenze più attuali che mettono la libreria al centro dell'arredo domestico. Spazi di servizio e di passaggio, ambienti con doppie altezze, mansarde, sotto scala non rappresentano vincoli ma opportunità. All'ampia modularità corrisponde un caleidoscopio di finiture anch'esso in continuo sviluppo: 35 colori laccati opachi Lemacolortrend, rovere Carbone, rovere Termotrattato, noce L per tutte le componenti del programma; laccato lucido in 22 colori per alcuni elementi. Vetri trasparenti, riflettenti, laccati colorati e argille in 5 colori per le facciate di ante e cassetti.

Thanks to the constant introduction of new finishing and elements, Selecta adapts to the evolution of living spaces. Tailored and standard, it meets every need, aesthetic or functional, in line with the most current trends that place the bookcase in the middle of home furnishing. Service and passage spaces, rooms with double heights, attics, under stair units do not represent constraints but opportunities. The wide modularity is matched by a kaleidoscope of finishing which is also in continuous development: 35 Lemacolortrend matt lacquered colours, Carbone oak, Heat-treated oak, L-walnut for all the components of the program; glossy lacquered in 22 colours for some elements. Transparent, reflective, coloured lacquered glass and clays in 5 colours for the facades of doors and drawers.

Bookcase par excellence, in continuous development, Selecta is extremely versatile from the point of view of compositions, finishing and uses. Domestic architectures free from schemes and constraints, tailored to each home and function of use.

# Disegni tecnici – Technical drawings

Sviluppo compositivo  
Components development

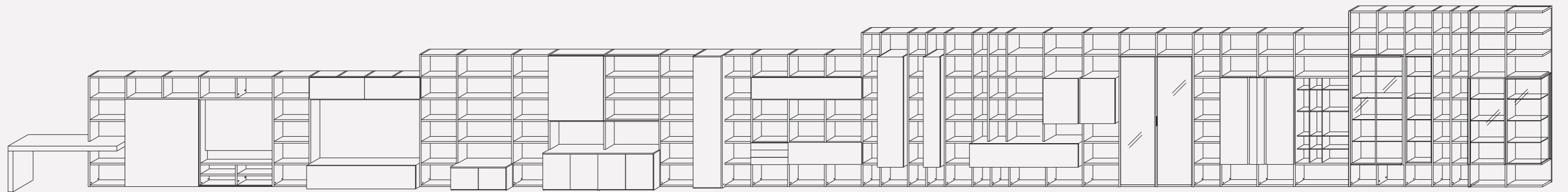



# Disegni tecnici – Technical drawings

Larghezze  
Widths

Profondità  
Depths

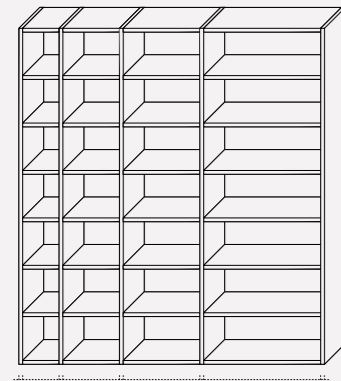

270,5 420 569 868 28  
10¼" 16½" 22½" 34¼" 1"

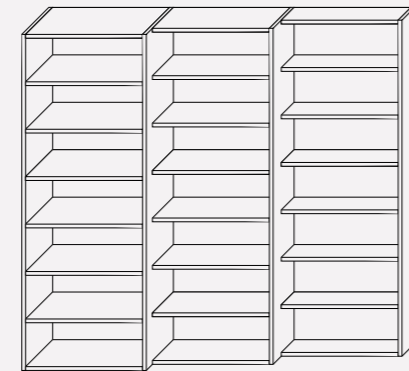

442 - 17½" 346 - 13½" 218 - 8½"

Altezze e profondità elementi sporgenti  
Heights and depths protruding elements

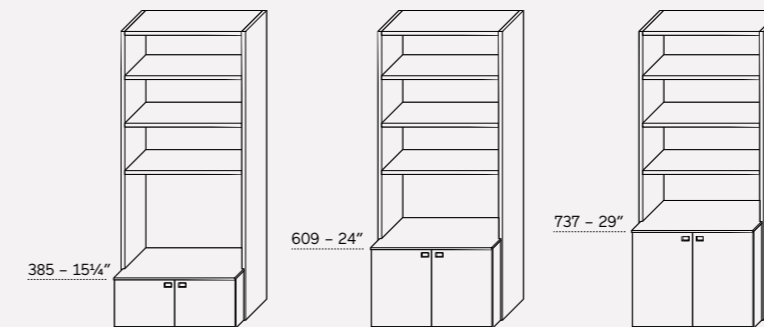

385 - 15¼" 468 - 18½" 609 - 24" 737 - 29"  
596 - 23½" 596 - 23½" 596 - 23½"  
814 - 32"

## Nicchie, Niches

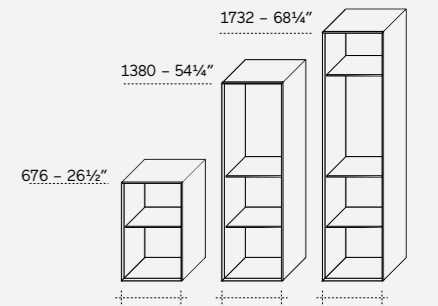

676 - 26½" 1380 - 54¼" 1732 - 68¼"  
420 - 569 420 - 569 420 - 569  
16½" - 22½" 16½" - 22½" 16½" - 22½"

Altezze  
Heights

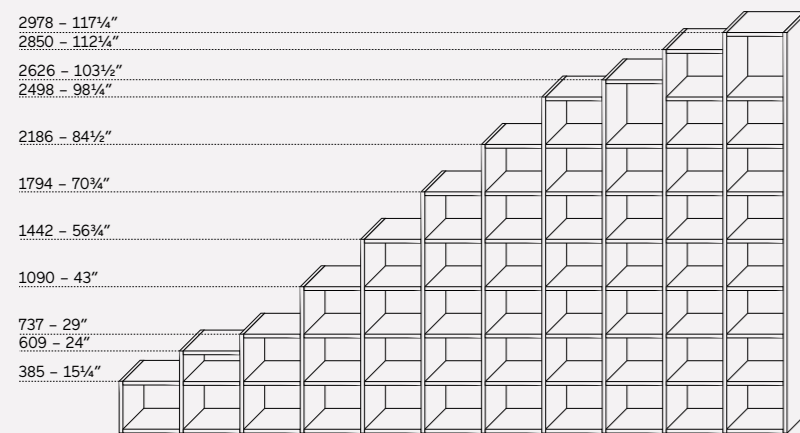

2978 - 117¼"  
2850 - 112¼"  
2626 - 103½"  
2498 - 98¼"  
2186 - 84½"  
1794 - 70¾"  
1442 - 56¾"  
1090 - 43"  
737 - 29"  
609 - 24"  
385 - 15¼"

## Ante Glance

Terminale  
Ending door

Sporgente  
Protruding door

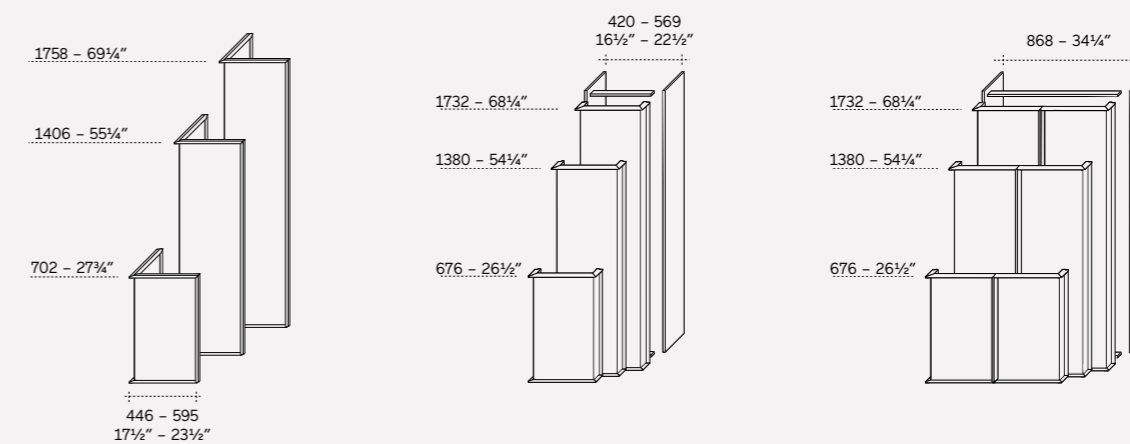

1758 - 69¼" 1406 - 55¼" 702 - 27¾" 446 - 595 17½" - 23½"  
1732 - 68¼" 1380 - 54¼" 676 - 26½" 420 - 569 16½" - 22½"  
1732 - 68¼" 1380 - 54¼" 676 - 26½" 868 - 34¼"

# Composizioni – Compositions

## Living Rooms – p. 18

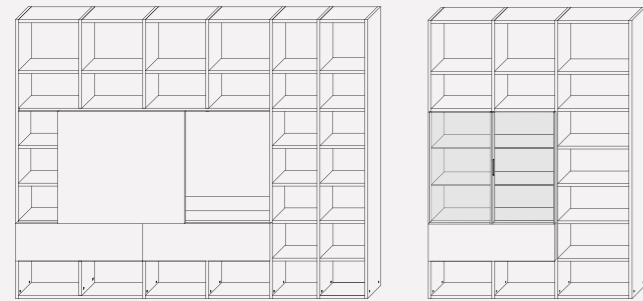

L. 3312 - 1921 H. 2626 P. 346  
W. 130½" - 75¼" H. 103½" D. 13½"

## Living Rooms – p. 24

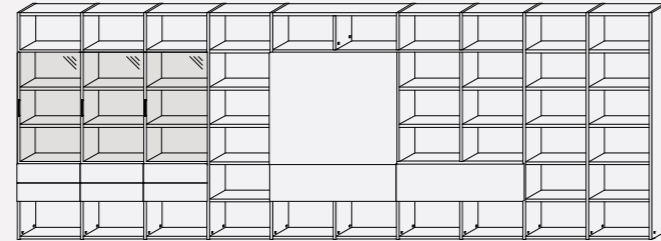

L. 5998 H. 2146 P. 346  
W. 236¼" H. 84½" D. 13½"

## Living Rooms – p. 40

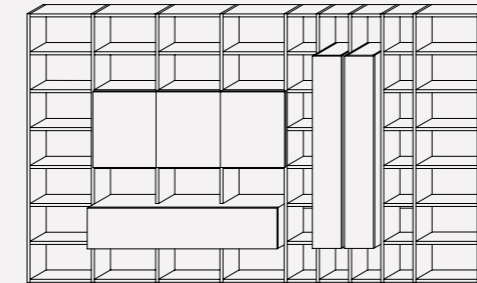

L. 4207 H. 2498 P. 500  
W. 165¾" H. 98¼" D. 19¾"

## Dining Rooms – p. 48

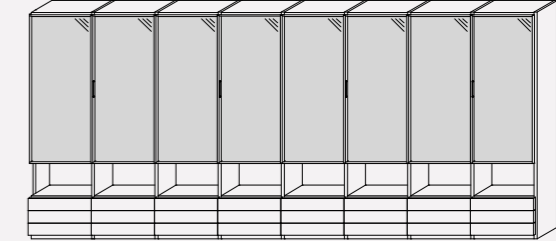

L. 4804 H. 2146 P. 442  
W. 189¼" H. 84½" D. 17½"

## Living Rooms – p. 30

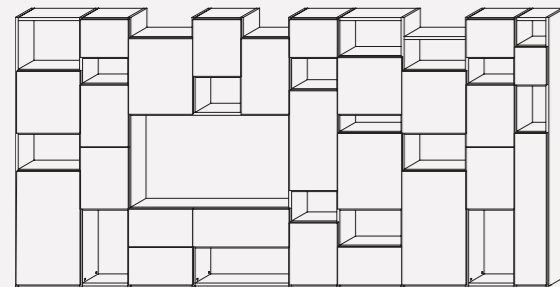

L. 4955 H. 2498 P. 346  
W. 195" H. 98¼" D. 13½"

## Living Rooms – p. 36

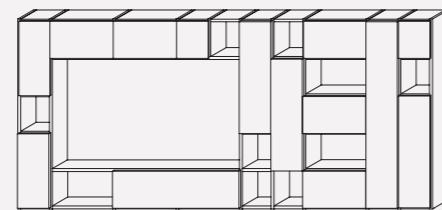

L. 3924 H. 1792 P. 346  
W. 154½" H. 70½" D. 13½"

## Dining Rooms – p. 52

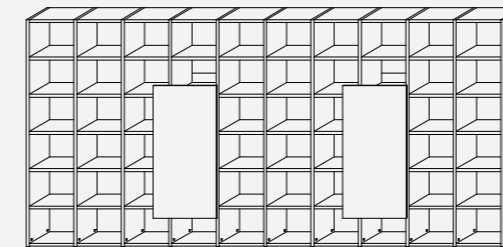

L. 4508 H. 2146 P. 442  
W. 177½" H. 84½" D. 17½"

## Dining Rooms – p. 58

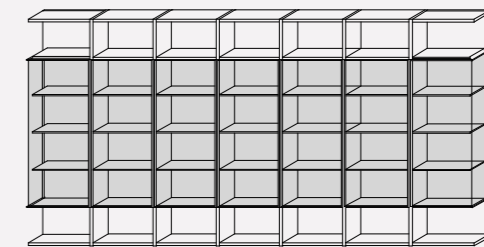

L. 4176 H. 2146 P. 346  
W. 164½" H. 84½" D. 13½"

# Composizioni – Compositions

Studio, Bookcases – p. 66

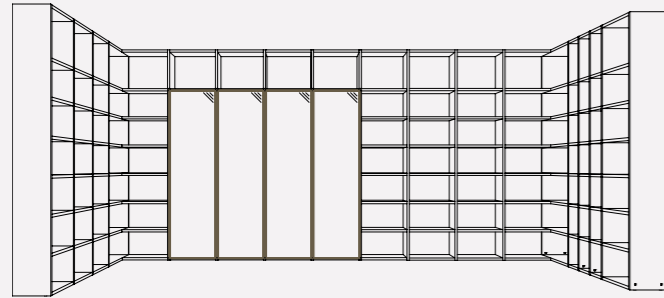

L. 6037 – 2715 – 2416 H. 2626 P. 346  
W. 237¼" – 107" – 95" H. 103½" D. 13½"

Studio, Bookcases – p. 70

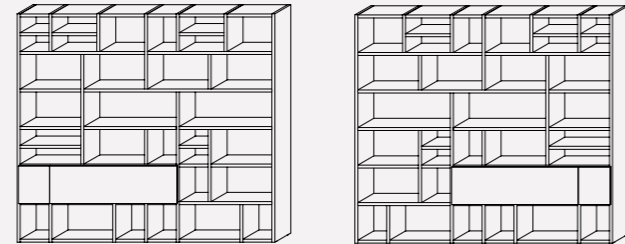

L. 2416 H. 2146 P. 346  
W. 95" H. 84½" D. 13½"

Studio, Bookcases – p. 84

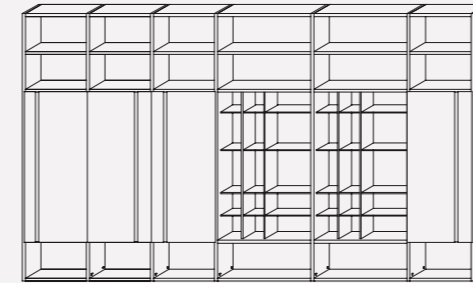

L. 4208 H. 2498 P. 346  
W. 165¼" H. 98¼" D. 13½"

Studio, Bookcases – p. 86

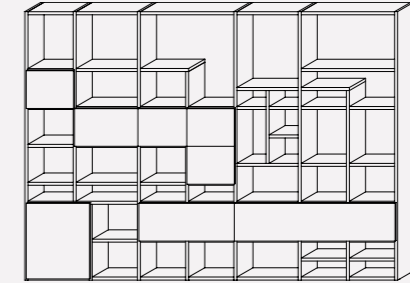

L. 3462 H. 2498 P. 346  
W. 136¼" H. 98¼" D. 13½"

Studio, Bookcases – p. 74

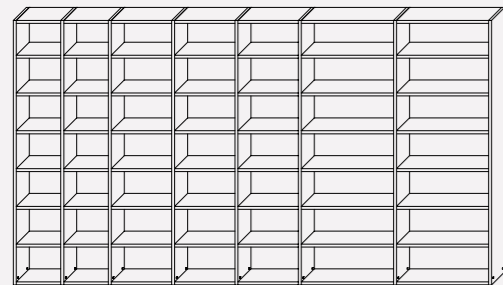

L. 4507 H. 2498 P. 346  
W. 177½" H. 98½" D. 13½"

Studio, Bookcases – p. 78

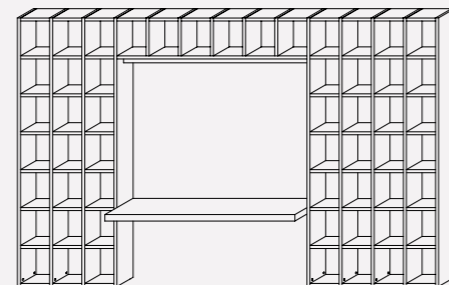

L. 3909 H. 2498 P. 600  
W. 154" H. 98¼" D. 23½"

Service Areas – p. 106

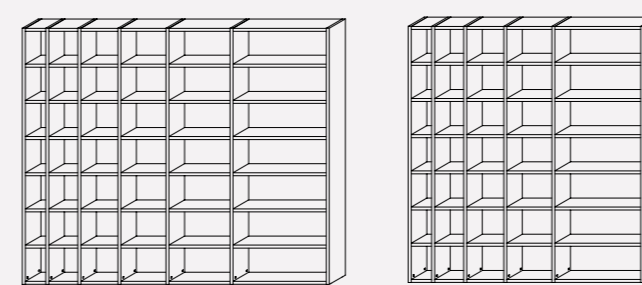

L. 2859 – 2194 H. 2390 P. 346  
W. 112½" – 86¼" H. 94" D. 13½"

Service Areas – p. 108

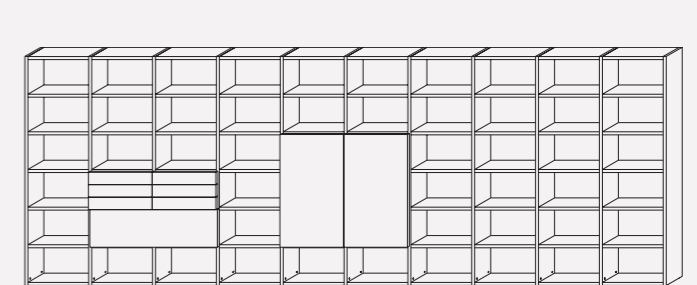

L. 5998 H. 2146 P. 346  
W. 236¼" H. 84½" D. 13½"

# Composizioni – Compositions

## Service Areas – p. 112

## Service Areas – p. 116

## Made to measure solutions – p. 134

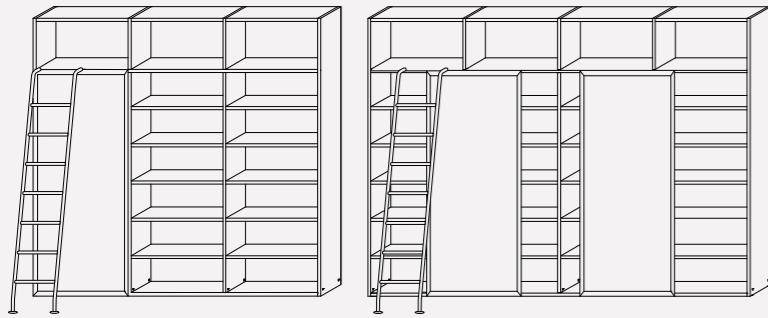

L. 2716 H. 2626 P. 442  
W. 107" H. 103½" D. 17½"

L. 3612 H. 2626 P. 442  
W. 142¼" H. 103½" D. 17½"

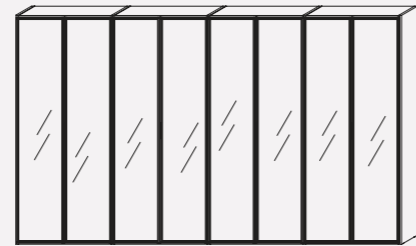

L. 3612 H. 2146 P. 346  
W. 142¼" H. 84½" D. 13½"

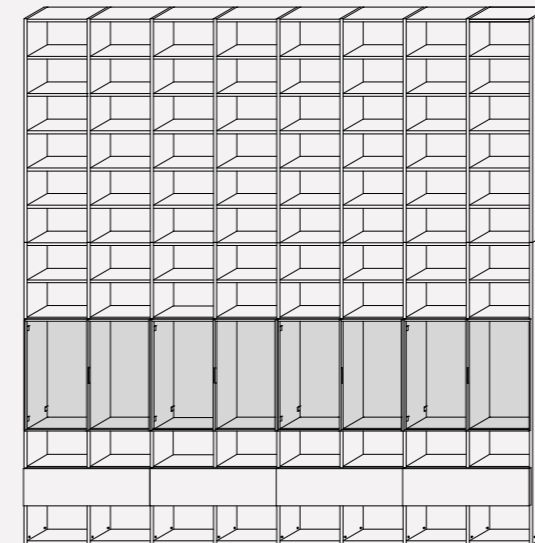

L. 4785 H. 4963 P. 442  
W. 188½" H. 195½" D. 17½"

## Service Areas – p. 122

## Made to measure solutions – p. 128

## Made to measure solutions – p. 140

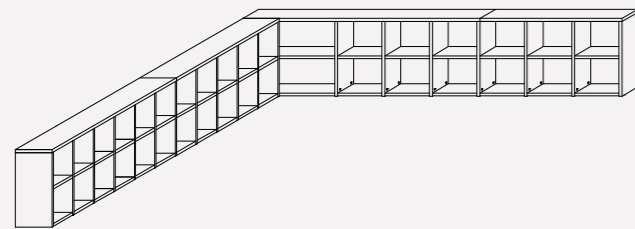

L. 5301 + 3584 H. 737 P. 346  
W. 208¾" + 141" H. 29" D. 13½"

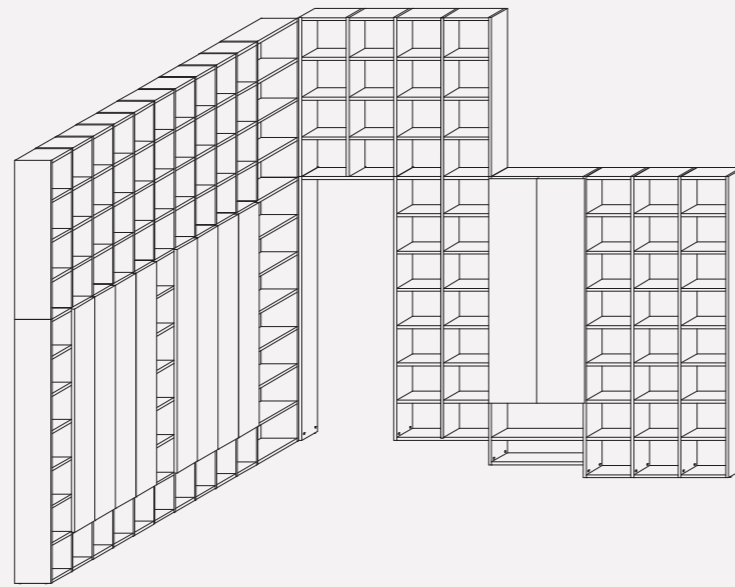

L. 5750 + 4060 H. 3996 – 2846 P. 346  
W. 226½" + 159¾" H. 157¼" – 112" D. 13½"

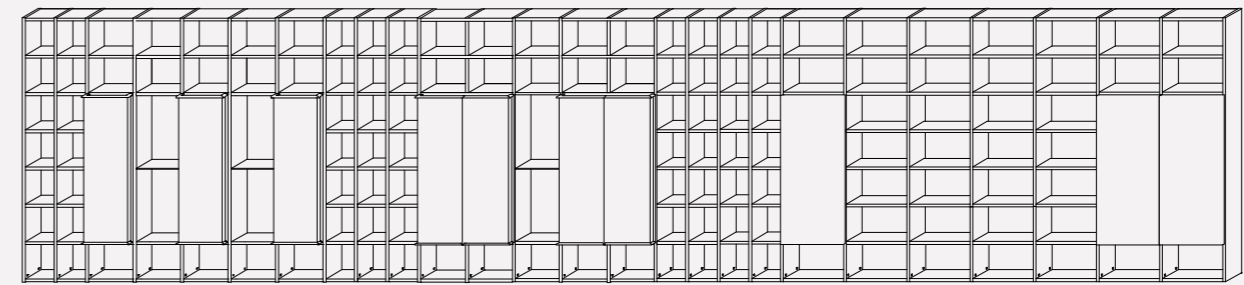
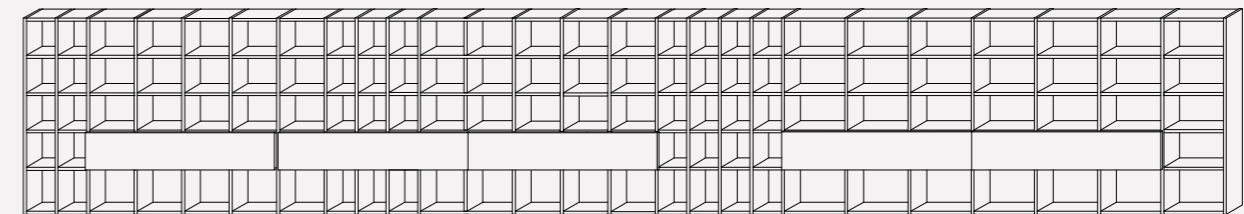

Sopra – Upper composition  
L. 11375 H. 1857 P. 346  
W. 447¾" H. 73" D. 13½"

Sotto – Bottom composition  
L. 11375 H. 2498 P. 346  
W. 447¾" H. 98¾" D. 13½"

# Composizioni – Compositions

Made to measure solutions – p. 146

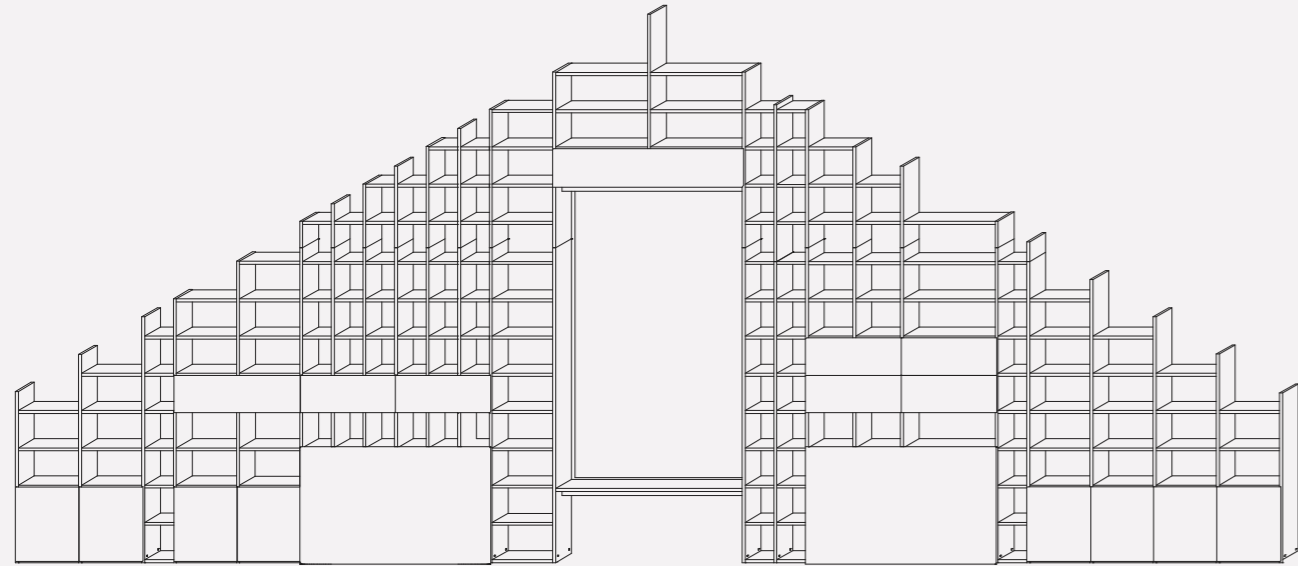

L. 11970 H. 895 – 5185 P. 346  
W. 471¼" H. 35¼" – 204¼" D. 13½"

# 6.

## SAMPLES COLLECTION

Lemacolortrend LCT — 170, 171

Argille, Clay — 171

Lemacolorlucido LCL — 172

Vetri, Glass — 173

Essenze, Woods — 173

Velluti, Velvets — 174

Metalli, Metals — 174

Lemacolortrend — LCT



Lemacolortrend — LCT



Argille, Clay

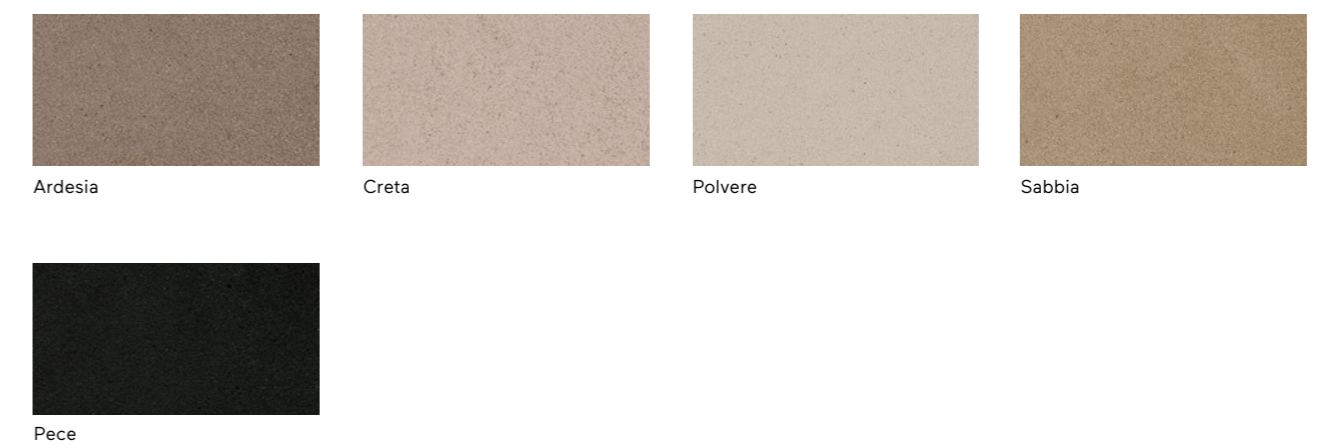

## Lemacolorlucido — LCL



Corrispondenza in LCT •  
Correspondence in LCT •

## Vetri, Glass

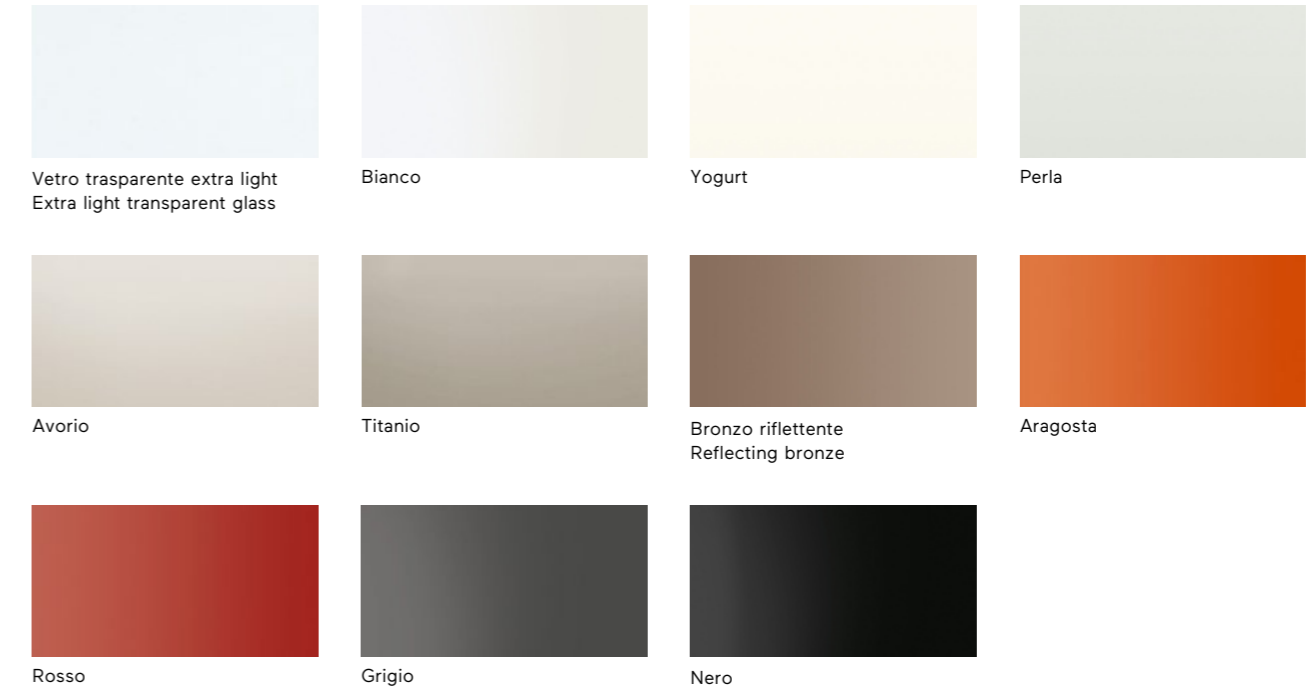

## Essenze, Woods

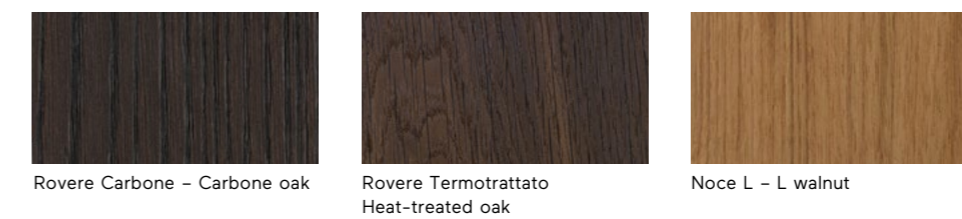



## Velluti, Velvets



Phobos TDC 447



Phobos TDC 448



Phobos TDC 469



Phobos TDC 466



Phobos TDC 460



Phobos TDC 450



Phobos TDC 451



Phobos TDC 462



Phobos TDC 446

## Metalli, Metals



Metallo anodizzato nero M101  
Anodized black metal M101

\* Consultare il campionario per visionare l'intera gamma cromatica.  
Consult the sample book to view the full color range available.

**Ad+Design**  
**Photo**  
**Styling**  
**Rendering**  
**Text**  
**Translation**  
**Repro**

**Graph.X**  
**Santi Caleca**  
**Studio Salaris**  
**Inside**  
**R+W**  
**Lema**  
**A. De Pedrini**

Thanks to

3Dotscollective  
Abc Italia  
Alessandra Roveda  
Amini  
Artigiani Del Cashmere  
Aum ceramiche  
Draga Obradovic  
Avalon  
C&C Milano  
Carl Hansen  
Cc Tapis  
Cecchi&Cecchi  
Christina Lassus  
Crizu  
Danese  
Designheure  
Discipline  
E15/Canova  
Ebb&Flow  
Fabrica  
Fontana Arte  
Golran  
Guaxs  
Gumdesign  
Ilaria I  
Incipitlab  
Jab  
Lithho  
Nani Marquina  
Next Materials  
Occra  
Oluce  
Pulpo  
Restart  
Scandola Marmo  
Serena Confalonieri  
Sklo studio  
Studio Baag  
Studio Salaris  
Tafuri ceramiche  
Tato Design  
Vanessa Mitraniw

关注LEMA微信公众号  
Follow LEMA WeChat account



公众号 ID : LemaOfficial

Seguici su – Follow us:  
Facebook, LinkedIn, Instagram, Pinterest, Youtube

Lema S.p.a.  
22040 Alzate Brianza  
Como — Italia  
Strada Statale  
Briantea N° 2  
T. +39 031 630 990  
[lemamobili.com](http://lemamobili.com)