

Armadio
al centimetro

TECHNICAL BOOK



Armadio
al centimetro

TECHNICAL BOOK

LEIVA



INDEX

1. Structure details — 10
2. Doors — 68
3. Wardrobe Open — 140
4. Wardrobe Tian — 146
5. Internal accessories — 164
6. Lema Air Cleaning System — 244

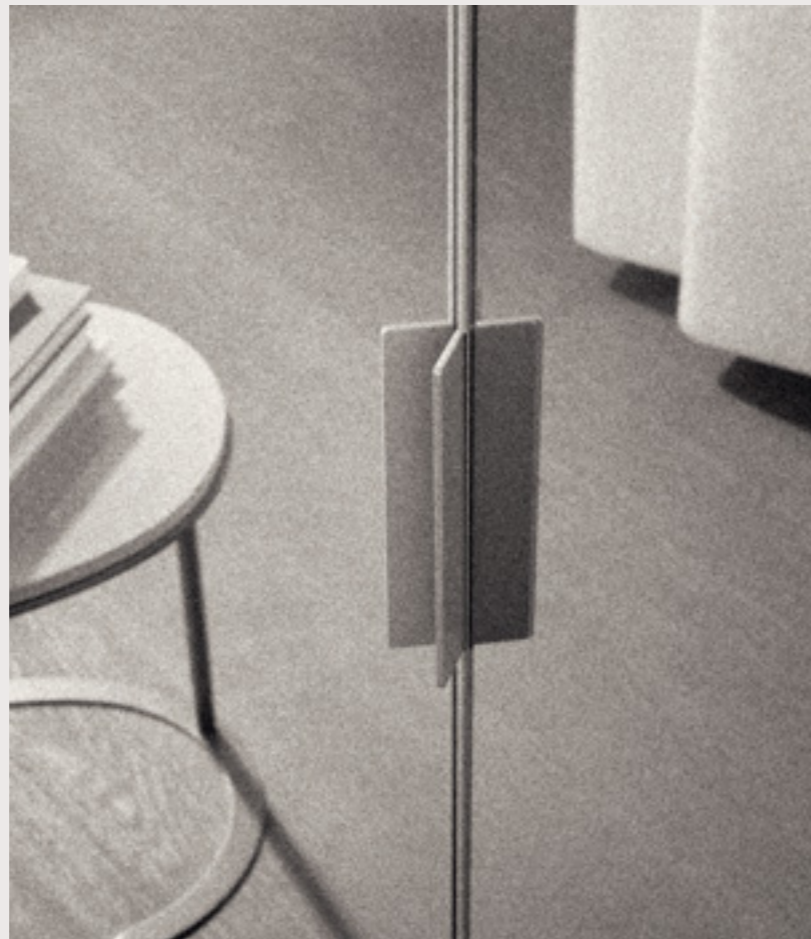

Indice

Structure details

Sistemi apertura — 12
Modularità — 13
Componenti struttura — 14
Angolari, terminali — 16
Fianchi esterni — 18
Profilo di finitura — 19
Fianchi interni — 20
Fianchi telaio — 21
Fondali — 22
Allineamenti — 23
Componibilità — 24
Cerniere — 26
Foratura — 30
Dettagli struttura — 31
Riduzioni — 32
Pannelli d'ispezione — 34
Lavorazioni speciali — 38
Fasce di chiusura — 40
Soluzioni particolari — 44
Vanity LT40 — 48
Vano lavatrice — 56
Armadio sovrapposto — 58
Passaggio porta, ponte armato — 59
Porta — 60
Colonna con cassettera esterna,
elemento a giorno — 62
Finiture struttura — 64

Doors

Ante battenti — 70
Ante scorrevoli — 78
Ante complanari — 84
Tipologia Ante — 90
Maniglie — 118
Serratura anta Dandy — 128
Finiture ante — 130

Open wardrobe

Componenti — 144
Struttura — 145

Tian wardrobe

Componenti — 150
Componibilità — 152
Fianchi, angolare e fondali — 154
Caratteristiche tecniche — 156
Attrezzatura — 157
Illuminazione verticale — 158
Illuminazione orizzontale — 160
Schema illuminazione — 161

Internal accessories

Allestimento interno — 166
Finiture attrezzatura — 174
Attrezzatura Comfort e Tech — 176
Fianco divisorio — 178
Supporto strutturale — 179
Ripiani — 180
Scarpiera — 186
Appendiere — 192
Vassoi e accessori — 198
Teca e accessori — 202
Portagioielli modulare — 206
Griglia portacamicie — 208
Accessori — 210
Cassettiere — 214
Cassettiere comfort e tech — 216
Cassettiere speciali — 218
Tipologie cassette — 220
Tipologie cassettiere — 224
Isola — 227
Accessori cassettiere — 228
Illuminazione orizzontale — 230
Illuminazione verticale — 234
Schema illuminazione — 236
Profilo elettrificato — 238
Contenitore per cablaggi — 240

Lema Air Cleaning System

Tecnologia — 246
Dettagli tecnici — 248

Abacus

Abaco tipologico ante — 252
Abaco finiture ante — 258
Abaco adattabilità attrezzature — 264

Contents

Structure details

- Opening systems — 12
- Modular systems — 13
- Structure components — 14
- Corner and end units — 16
- External sides — 18
- Finishing profiles — 19
- Internal sides — 20
- Frame sides — 21
- Back panels — 22
- Alignments — 23
- Layouts — 24
- Hinges — 26
- Drilling — 30
- Structure details — 31
- Reductions — 32
- Access panels — 34
- Special processing — 38
- Filler panels — 40
- Bespoke solutions — 44
- Vanity LT40 — 48
- Washing machine compartment — 56
- Overlapping wardrobe — 58
- Passage and bridge solution — 59
- Door — 60
- Column with external drawers, open element — 62
- Structure finishings — 64

Doors

- Hinged doors — 70
- Sliding doors — 78
- Coplanar doors — 84
- Type of doors — 90
- Handles — 118
- Lock for Dandy door — 128
- Doors finishings — 130

Open wardrobe

- Components — 144
- Structure — 145

Tian wardrobe

- Components — 150
- Layouts — 152
- Sides, corners and back panels — 154
- Technical characteristics — 156
- Equipment — 157
- Vertical lighting — 158
- Horizontal lighting — 160
- Lighting details — 161

Internal accessories

- Internal layout — 166
- Equipment finishings — 174
- Comfort and Tech equipment — 176
- Divider side — 178
- Structural support — 179
- Shelves — 180
- Shoe cabinets — 186
- Hanging bars — 192
- Trays and accessories — 198
- Display case and accessories — 202
- Modular jewellery holder — 206
- Shirt rack — 208
- Accessories — 210
- Drawer units — 214
- Comfort and Tech drawers unit — 216
- Special drawers unit — 218
- Drawer types — 220
- Drawer units types — 224
- Island — 227
- Drawer units accessories — 228
- Horizontal lighting — 230
- Vertical lighting — 234
- Lighting details — 236
- Electrified profile — 238
- Cable box — 240

Lema Air Cleaning System

- Technology — 246
- Technical details — 248

Abacus

- Abacus door types — 252
- Abacus door finishings — 258
- Abacus equipment adaptability — 264

1.

STRUCTURE DETAILS

Armadio al Centimetro offre la possibilità di costruire uno spazio domestico riservato e personale. Per questo nasce come progetto incentrato sulla massima flessibilità: di dimensioni prima di tutto, ma anche di modelli, materiali, elementi, finiture, accessori, attrezzature. Una varietà di componenti che dedicano a ognuno la massima scelta, secondo le singole necessità e i gusti. Il sistema si sviluppa intorno ai moduli base formati da strutture e ante: battenti, scorrevoli e complanari.

Armadio al Centimetro offers the possibility of creating a private and very personal domestic space. For this reason the project focused from the very start on creating maximum flexibility, principally as regards the dimensions but also in terms of models, materials, elements, finishings and accessories. A wide variety of components gives everyone the maximum choice, enabling people to select according to their own needs and tastes. The system develops around the base modules formed of structures and doors: hinged, sliding and coplanar.

Sistemi Apertura — Opening Systems

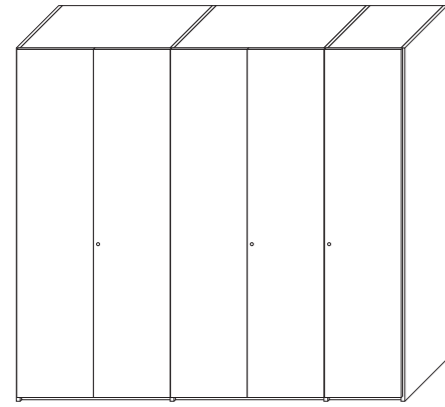

01

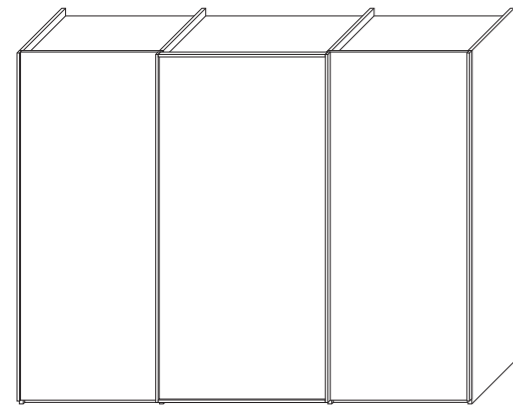

02

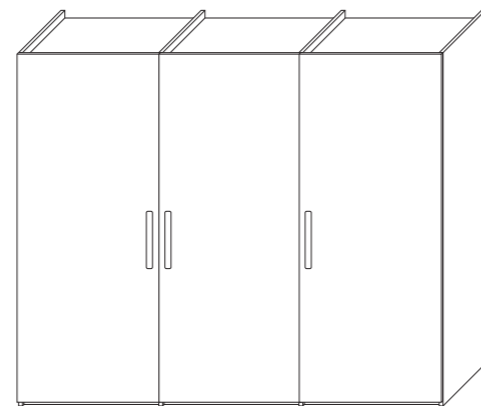

03

01

Ante battenti
Hinged doors

Prima
Flago
Text
Next
Elegant
Kyn
Ellevi
Naica
Nur
Emery
Dandy
Warm
Seryasse

02

Ante scorrevoli
Sliding doors

Prima
Text
Ellevi
Naica
Emery
Warm

03

Ante complanari
Coplanar doors

Prima
Text
Ellevi
Naica
Emery
Warm

Altezze disponibili
Available height
2048 - 2368 - 2464 -
2624 - 2880

80¾" - 93¾" - 97" -
103¼" - 113½"

Modularità — Modularity

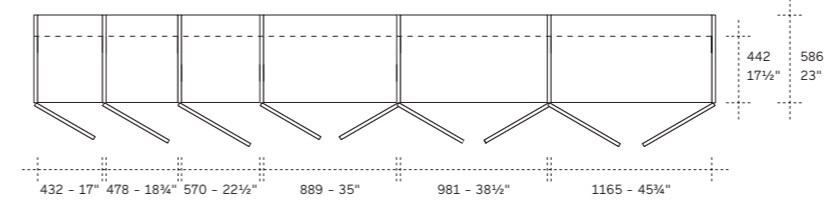

01

Larghezza colonne ante battente
Column width for hinged doors

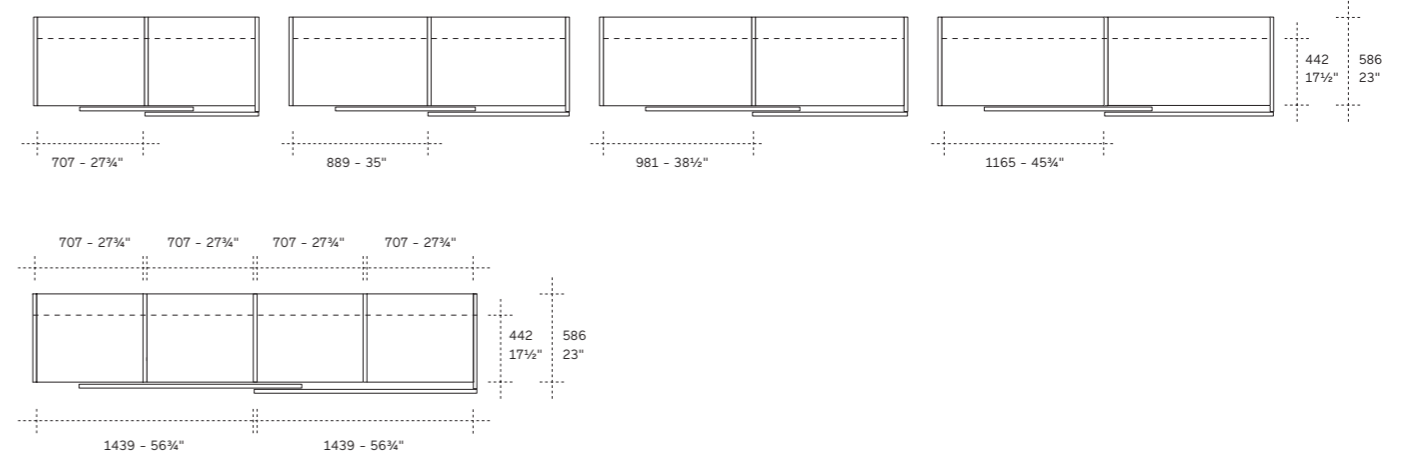

02

Larghezza colonne ante scorrevole
Column width for sliding doors

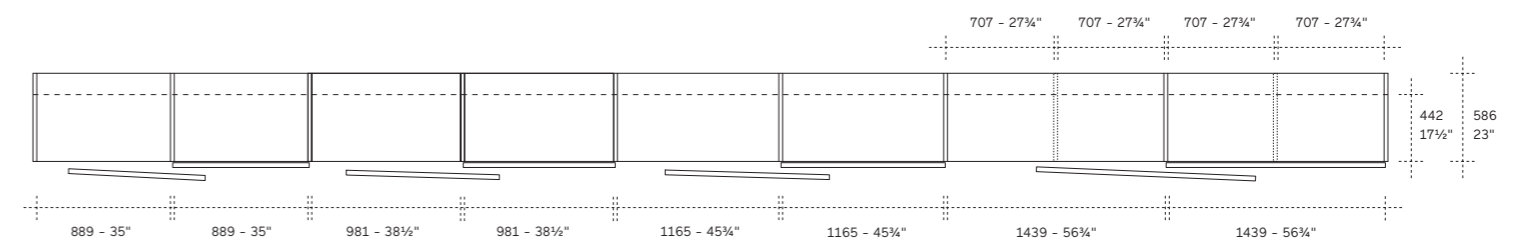

03

Larghezza colonne ante complanare
Column width for coplanar doors

Componenti Struttura — Structural Components

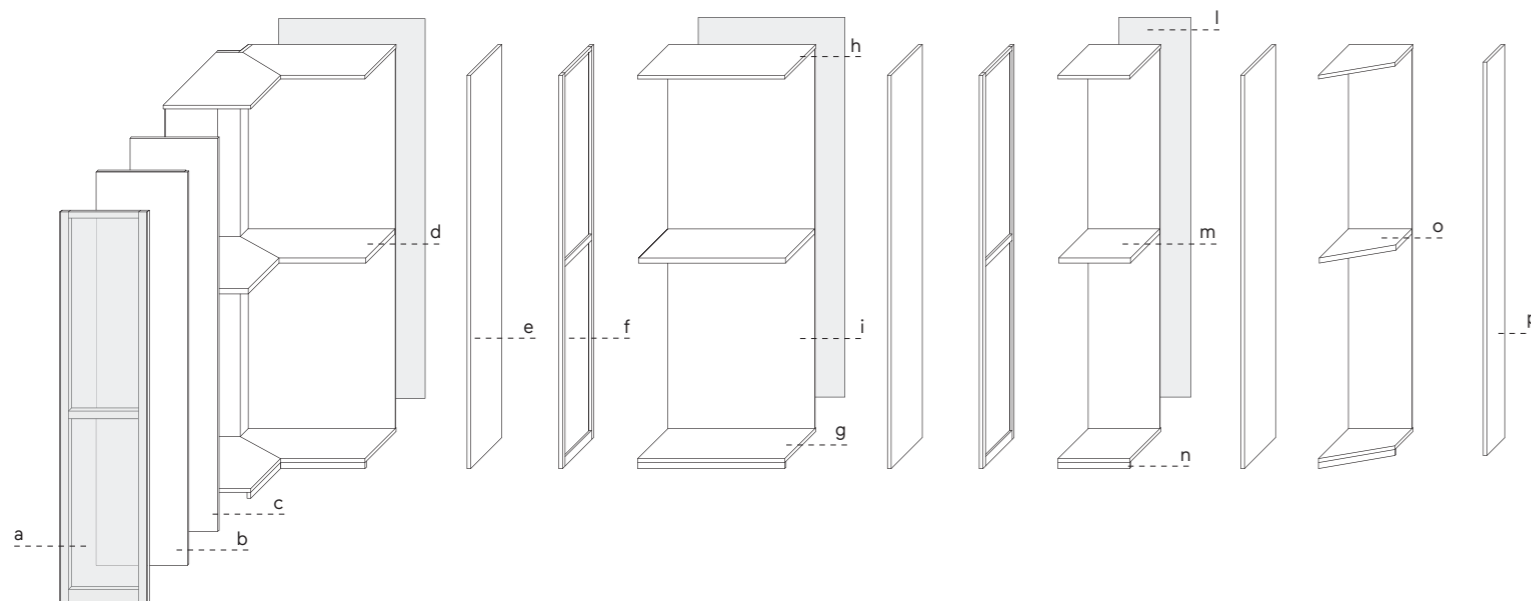

Componenti struttura Structural components

a. fianco esterno vetro	a. external side in glass
b. fianco esterno finitura	b. external finishing side
c. fianco esterno	c. external side
d. ripiano angolare	d. corner shelf
e. fianco interno	e. internal side
f. fianco interno telaio	f. internal frame side
g. base	g. base
h. coperchio	h. top
i. fondale	i. back panel
l. fondale vetro	l. glass back panel
m. ripiano	m. shelf
n. zoccolo	n. plinth
o. ripiano per colonna terminale	o. shelf for end column
p. fianco esterno terminale	p. external end side

Nota Note

A partire dal vano larghezza 707, è possibile inserire un "supporto strutturale per fondale" per evitare problemi di flessione

Starting from column width 707 - 27¾", it is possible to insert a "structural support for back panel" to avoid bending problems

Pag. 179
On page 179

a. Fianco esterno vetro Glass external side

Spessore - Thickness
33 - 1¼"

Altezza - Height
2368 - 2464 - 2624 - 2880
93¼" - 97" - 103¼" - 113½"

Profondità - Depth
586 - 23"

Finiture - Finishings
Telaio metallo verniciato:
bronzo epox M421
sand epox M455
Vetro:
vetro trasparente
vetro fumé grigio
vetro bronzo riflettente

Frame:
metal painted bronze epox M421
sand epox M455
Glass:
transparent glass
grey smoked glass
reflecting bronze glass

b. Fianco esterno di finitura External finishing side

Spessore - Thickness
14 - ½"

Altezza - Height
2368 - 2464 - 2624 - 2880
93¼" - 97" - 103¼" - 113½"

**Profondità per fianco 586
Depth for side panel 586**
613 - 618 - 629
24¼" - 24¼" - 24¾"

**Profondità per fianco 442
Depth for side panel 442**
469 - 474 - 485
18½" - 18¾" - 19"

**Finiture esterne
External finishings**
laccato opaco LCT
laccato lucido LCL
rovere carbone
rovere grigio
rovere termotrattato
noce-L

matt lacquered LCT
glossy lacquered LCL
carbone oak
grey oak
heat-treated oak
walnut-L

c. Fianco esterno External side

Spessore - Thickness
25 - 1"

Altezza - Height
2048 - 2368 - 2464 - 2624 - 2880
80¾" - 93¼" - 97" - 103¼" - 113½"

Profondità - Depth
442 - 586
17½" - 23"

Profondità - Depth
(con anta esterna scorrevole)
(with sliding external door)
480 - 624
19" - 24½"

**Finiture esterne
External finishings**
melaminico 6 varianti
laccato opaco LCT
laccato lucido LCL
rovere carbone
rovere grigio
rovere termotrattato
noce-L

melaminico 6 varianti
matt lacquered LCT
glossy lacquered LCL
carbone oak
grey oak
heat-treated oak
walnut-L

d. Ripiano angolare Corner shelf

Spessore - Thickness
35 - 1½"

**Dimensioni per fianco 586
Dimensions for side panel 586**
1084 x 1084 x 500 (comfort)
1084 x 1084 x 507 (tech)
42¾" x 42¾" x 19¾" (comfort)
42¾" x 42¾" x 20" (tech)

**Dimensioni per fianco 442
Dimensions for side panel 442**
939 x 939 x 402 (comfort)
939 x 939 x 408 (tech)
37" x 37" x 15¾" (comfort)
37" x 37" x 16" (tech)

**Tipologie e finiture
Types and finishings**
pag. 182 - 183
on p. 182 - 183

e. Fianco interno Internal side

Spessore - Thickness
25 - 1"

Altezza - Height
2048 - 2368 - 2464 - 2624 - 2880
80¾" - 93¼" - 97" - 103¼" - 113½"

2308 - 2404 - 2564
90¾" - 94¾" - 101"
(complanare)

Profondità - Depth
442 - 586
17½" - 23"

Finiture - Finishings
melaminico 6 varianti
melamine 6 variants

f. Fianco interno telaio Internal frame side

Spessore - Thickness
25 - 1"

Altezza - Height
2368 - 2464 - 2624 - 2880
93¼" - 97" - 103¼" - 113½"

Profondità - Depth
586 - 23"

Finiture - Finishings
Telaio metallo verniciato:
bronzo epox M421
sand epox M455

frame:
metal painted bronze epox M421
sand epox M455

g. - h. Base e coperchio Base and top

Spessore - Thickness
25 - 1"

Larghezza - Width
432 - 478 - 570 - 707 - 889 - 981 - 1165
17" - 18¾" - 22½" - 27¾" - 35" - 38½" - 45¾"

Profondità - Depth
441 - 585
17¼" - 23"

Finiture - Finishings
melaminico 6 varianti
melamine 6 variants

i. Fondale Back panel

Spessore - Thickness
8 - ¾"

Larghezza - Width
442 - 488 - 580 - 717 - 899 - 991 - 1175
17½" - 19¼" - 22¾" - 28¾" - 35½" - 39" - 46¼"

Altezza - Height
1968 - 2288 - 2384 - 2544 - 2800 (battente)
77½" - 90" - 93¼" - 100¼" - 110¾" (hinged)

2208 - 2304 - 2464 - 2720 (scorrevole)
87" - 90¾" - 97" - 107"
(sliding)

2208 - 2304 - 2464 (complanare)
87" - 90¾" - 97" (coplanar)

Finiture - Finishings
melaminico 6 varianti
rivestimento decorativo tessile
melamine 6 variants
decorative fabric covering

l. Fondale vetro Glass back panel

disponibile solo per armadio battente
only available for hinged door wardrobe

Spessore - Thickness
4 - 1"

Larghezza - Width
440 - 486 - 578 - 897 - 989 - 1173
17¼" - 19¼" - 22¾" - 35¾" - 39" - 46¼"

Altezza - Height
2286 - 2382 - 2542 - 2798
90" - 93¼" - 100" - 110¾"

Finiture - Finishings
vetro trasparente
vetro fumé grigio
vetro bronzo riflettente

transparent glass
grey smoked glass
reflecting bronze glass

m. Ripiano - Shelf

Spessore - Thickness
35 - 1½"

Larghezza - Width
432 - 478 - 570 - 707 - 889 - 981 - 1165
17" - 18¾" - 22½" - 27¾" - 35" - 38½" - 45¾"

**Profondità per fianco 586
Depth for side panel 586**
441 - 585
17¼" (comfort) - 20" (tech)

**Profondità per fianco 442
Depth for side panel 442**
402 (comfort) - 408 (tech)
15¾" (comfort) - 16" (tech)

**Tipologie e finiture
Types and finishings**
pag. 180 - 181
on p. 180 - 181

n. Zoccolo - Plinth

Spessore - Thickness
25 - 1"

Larghezza - Width
max. 3270 - 128¾"

Altezza - Height
40 - 1½"

Finiture - Finishings
melaminico 6 varianti
laccato opaco LCT
laccato lucido LCL
rovere carbone
rovere grigio
rovere termotrattato
noce-L

matt lacquered LCT
glossy lacquered LCL
carbone oak
grey oak
heat-treated oak
walnut-L
verniciato bronzo epox M421 (per fianco telaio)
verniciato sand epox M455 (per fianco telaio)

melamine 6 variants
matt lacquered LCT
glossy lacquered LCL
carbone oak
grey oak
heat-treated oak
walnut-L
painted bronze epox M421 (for frame side)
painted sand epox M455 (for frame side)

o. Ripiano per colonna terminale Shelf for end column

Spessore - Thickness
35 - 1½"

**Dimensioni (L x P)
Dimensions (W x D)**
418 x 500
16½" x 19¾"

Finiture - Finishings
melaminico 6 varianti
melamine 6 variants

p. Fianco esterno terminale solo per battente External end side hinged door only

Spessore - Thickness
25 - 1"

Altezza - Height
2048 - 2368 - 2464 - 2624 - 2880
80¾" - 93¼" - 97" - 103¼" - 113½"

Profondità - Depth
326 - 12¾"

**Finiture esterne
Finishings**
melaminico 6 varianti
laccato opaco LCT
laccato lucido LCL
rovere carbone
rovere grigio
rovere termotrattato
noce-L

melamine 6 variants
matt lacquered LCT
glossy lacquered LCL
carbone oak
grey oak
heat-treated oak
walnut-L

Profilo di finitura
in aggiunta al fianco battente esterno in legno
in addition to the external hinged side in wood

Spessore - Thickness
12 - ½"

Altezza - Height
2048 - 2368 - 2464 - 2624 - 2880
80¾" - 93¼" - 97" - 103¼" - 113½"

Profondità - Depth
26 - 30 - 17
1" - 1¼" - ¾"

Finiture - Finishings
laccato opaco LCT
rovere carbone
rovere grigio
rovere termotrattato
noce-L

matt lacquered LCT
carbone oak
grey oak
heat-treated oak
walnut-L

**Nota
Note**
Finiture da pag. 132
Finishings on page 132

Angolari, terminali — Corner, end-unit

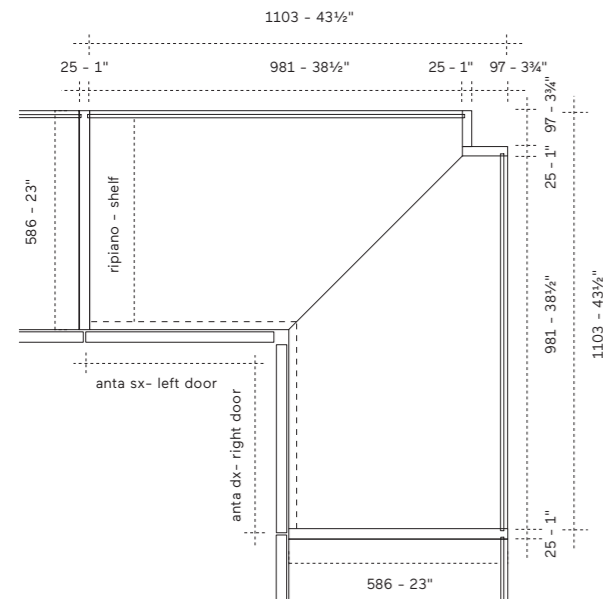

01

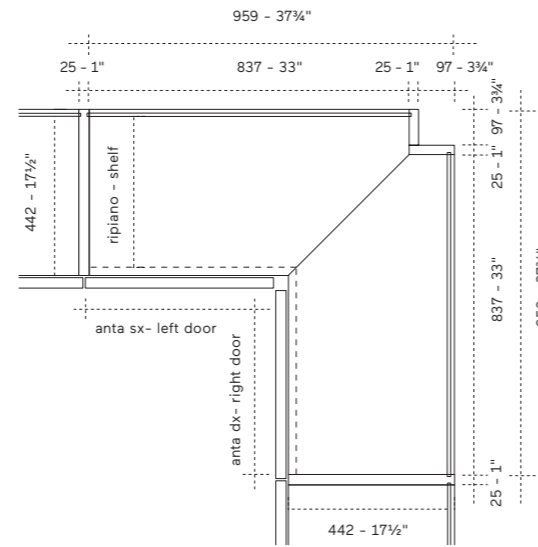

02

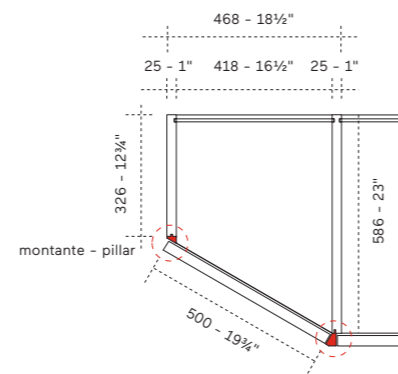

03



01 - 02



03

01 - 02

Colonna angolare Corner column	Altezza Height	Ripiano angolare comfort Comfort corner shelf
	2048 - 2368 - 2464 - 2624 - 2880	
Dimensioni colonna Column dimensions	80 3/4" - 93 1/4" - 97" - 103 1/4" - 113 1/2"	Dimensioni Dimensions
Per fianco 586: For side panel 23": 1103 x 1103 x 586 43 1/4" x 43 1/4" x 23"		Per fianco 586: For side panel 23": comfort 1084 x 1084 x 500 42 3/4" x 42 3/4" x 19 3/4"
Per fianco 442: For side panel 17 1/2": 959 x 959 x 442 37 1/4" x 37 1/4" x 17 1/2"		tech 1084 x 1084 x 507 42 3/4" x 42 3/4" x 20"

03

Colonna terminale End column	Ripiano per colonna terminale Shelf for end column
Dimensioni colonna Column dimensions	Dimensioni Dimensions
468 x 586 18 1/2" x 23"	418 - 500 16 1/2" - 19 3/4"
Altezza Height	
2048 - 2368 - 2464 - 2624 - 2880 80 3/4" - 93 1/4" - 97" - 103 1/4" - 113 1/2"	

01 - 02

Colonna angolare Corner column	Ante battenti disponibili e larghezza Available doors and width
	sx dx
Prima 500	497
Flago 500	497
Text 500	497
Next 520	497
Elegant 520	497
Kyn 500	496
Ellevi 500	497
Naica 500	494
Nur 25 500	497
Nur 28 500	494
Dandy 500	484
Emery 500	500
Warm 500	492

03

Colonna terminale End column	Ante battenti disponibili e larghezza Available doors and width
Prima 500	500
Flago 500	500
Text 500	500
Next 500	500
Elegant 500	500
Kyn 500	500
Ellevi 500	500
Emery 500	500

Nota
Note
Nella colonna terminale è presente un profilo sagomato installato sul fianco esterno e sull'anta
In end unit column is foreseen a shaped profile installed both on external side panel and door

Fianchi esterni — External side panel

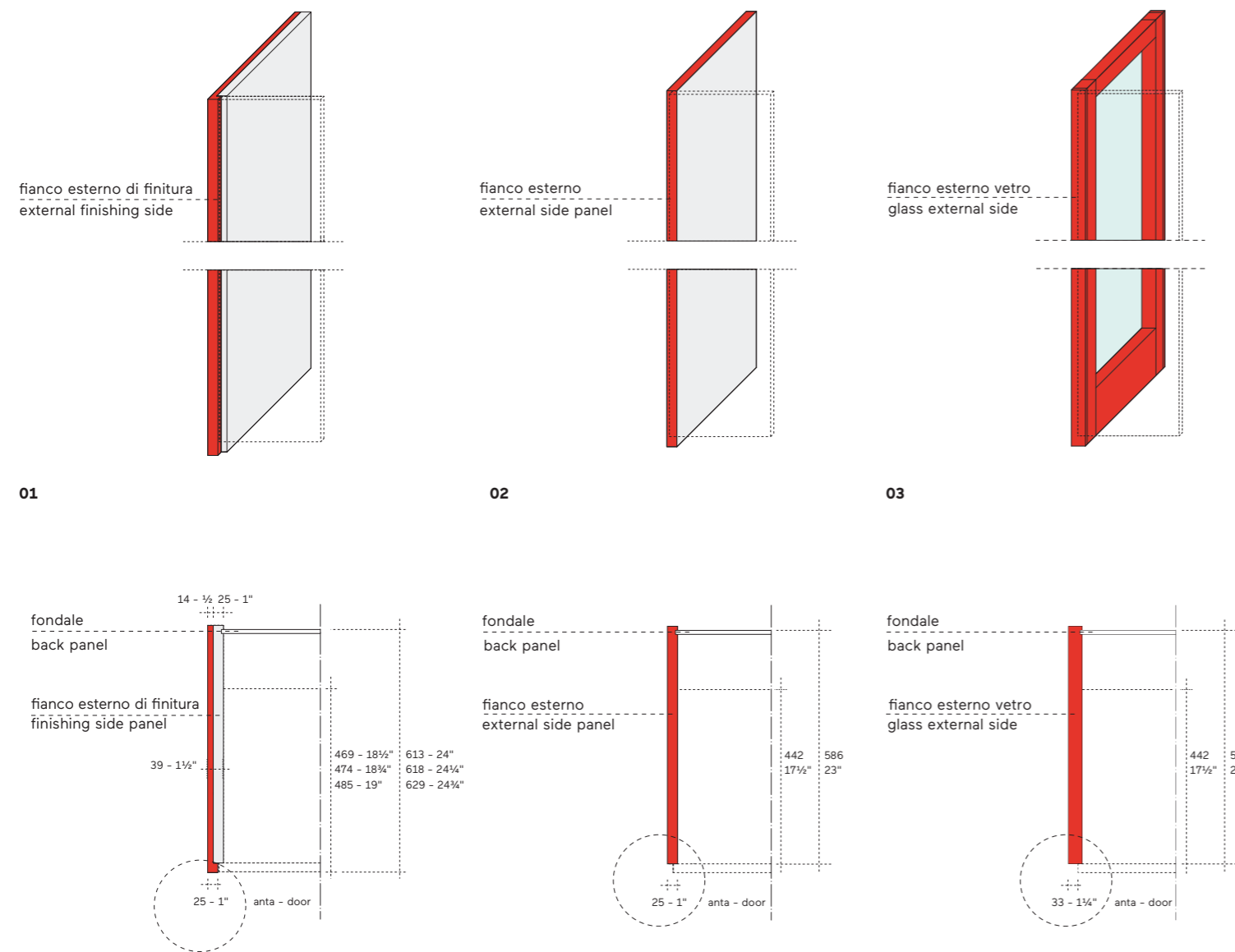

01	Fianco esterno di finitura** External finishing side**	Profondità 469 - 613 per ante spessore 25 Depth 18 1/2" - 24 1/4" for door thickness 1"	Profondità 474 - 618 per ante spessore 27-28-30 Depth 18 3/4" - 24 1/4" for door thickness 1" - 1/4"	Fianco esterno* External side panel*	Fianco esterno vetro Glass external side	Profondità Depth 442 - 480 - 586 - 624 (per anta scorrevole esterna) 17 1/2" - 19" - 23" - 24 1/2" (for sliding external door)	Spessore Thickness 25 1"	03.	Fianco esterno vetro Glass external side	Profondità Depth 586 23"	Spessore Thickness 1 1/4"	* Il fianco esterno è disponibile per tutti i tipi di anta battente, scorrevole e coplanare The external side panel is available for all types of hinged, sliding and coplanar doors
-----------	---	--	---	---	---	---	---	------------	---	---	---	---

Profilo di finitura — Finishing profile

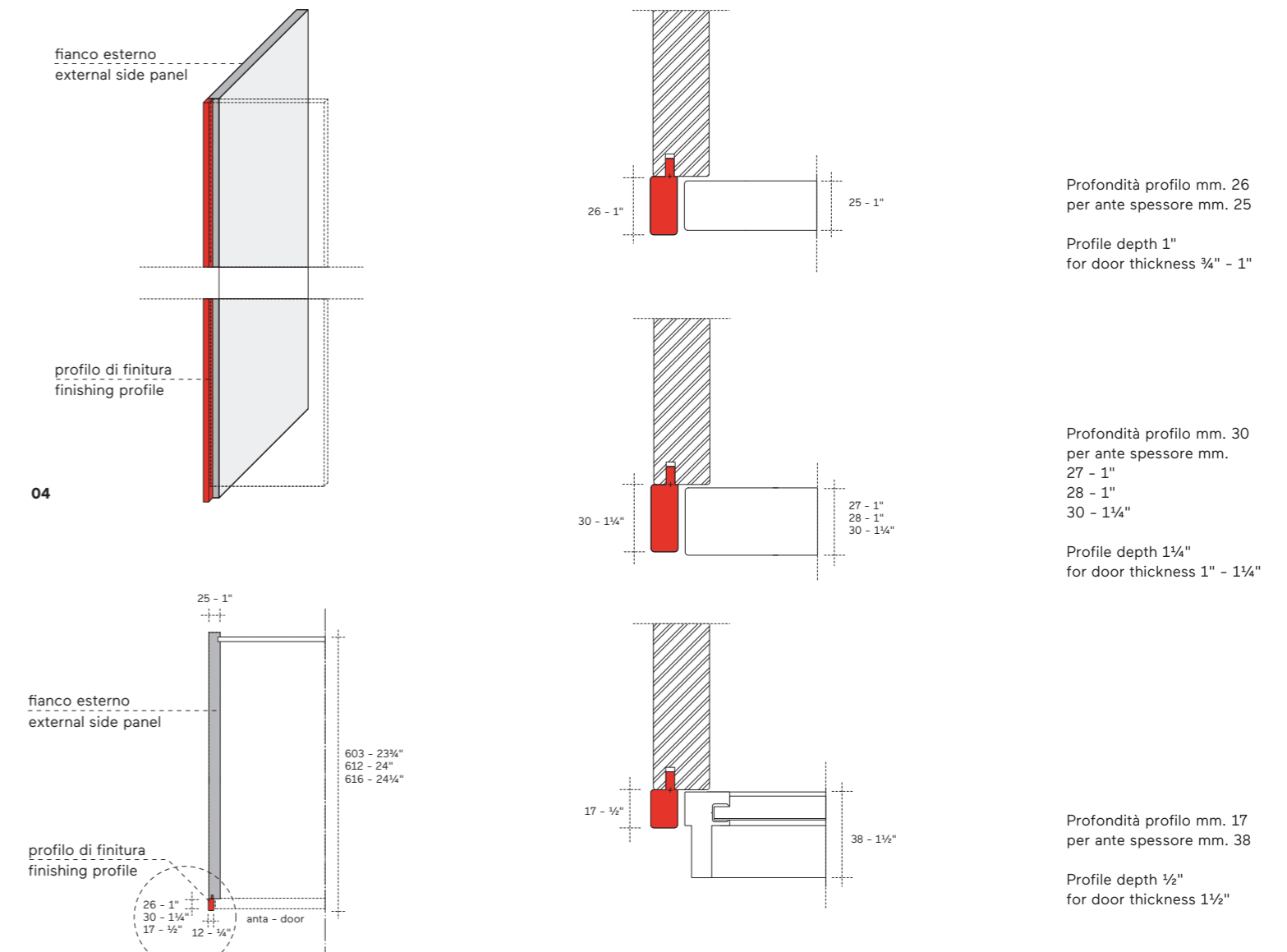

04	Profilo di finitura** (opzionale) Finishing profile** (optional)	Profondità 26 per ante spessore 25 Depth 1" for door thickness 1"	Profondità 30 per ante spessore 27 - 28 - 30 Depth 1 1/4" for door thickness 1" - 1 1/4"	Profondità 17 per ante spessore 38 Depth 1/2" for door thickness 1 1/2"	** Disponibile solo per anta battente Available only for hinged doors
-----------	---	--	---	--	--

Fondali — Back panels

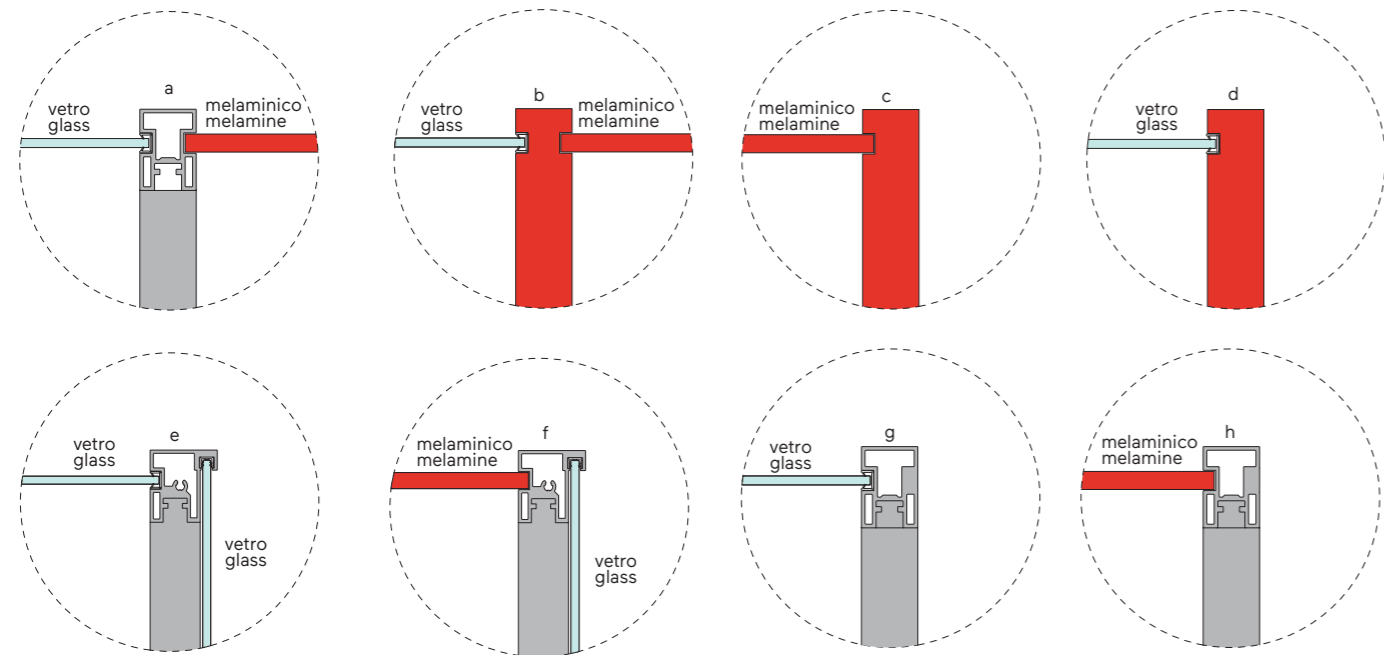
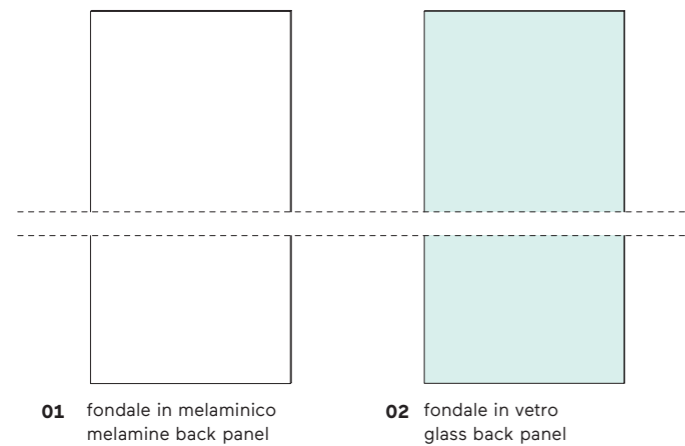

<p>01</p> <p>Fondale melaminico** Melamine back panel**</p> <p>Spessore Thickness</p> <p>8 ¼"</p> <p>Larghezza Width</p> <p>442 - 488 - 580 - 717 - 899 - 991 - 1175 17½" - 19¼" - 22¾" - 28¾" - 35½" - 39" - 46¼"</p> <p>Altezza Height</p> <p>per battente - for hinged 1968 - 2288 - 2384 - 2544 - 2800 77½" - 90" - 93¾" - 100¼" - 110¼"</p> <p>per scorrevole - for sliding 2208 - 2304 - 2464 - 2720 87" - 90¾" - 97" - 107"</p> <p>per coplanare for coplanar 2208 - 2304 - 2464 87" - 90¾" - 97"</p>	<p>02</p> <p>Fondale vetro Glass back panel</p> <p>Spessore Thickness</p> <p>4 - ¼"</p> <p>Larghezza Width</p> <p>440 - 486 - 578 - 897 - 989 - 1173 17¼" - 19¼" - 22¾" - 35¼" - 39" - 46¼"</p> <p>Altezza Height</p> <p>2286 - 2382 - 2542 - 2798 90" - 93¾" - 100" - 110¼"</p>	<p>a - b - c - d - e - f</p> <p>Combinazione fianco-fondale Combination side-back panel</p> <p>a Fianco interno telaio Internal frame side panel</p> <p>e - f Fianco esterno vetro + fondale in melaminico o vetro External side panel + melamine back panel or glass</p> <p>b Fianco interno melaminico Melamine internal side panel</p> <p>c - d Fianco esterno melaminico External side panel</p> <p>g-h Fianco esterno telaio passante per soluzione Open External frame side for Open wardrobe</p>	<p>Nota Note</p> <p>In presenza di fondale in vetro l'illuminazione orizzontale è disponibile solamente con profilo elettrificato pag. 238</p> <p>If a glass back panel is present, horizontal lighting is only available with the electrified profile as per page 238</p> <p>** Non utilizzabile nella soluzione bi-fronte</p> <p>Cannot be used in double-faced solutions</p>
---	---	---	--

Allineamenti — Alignments

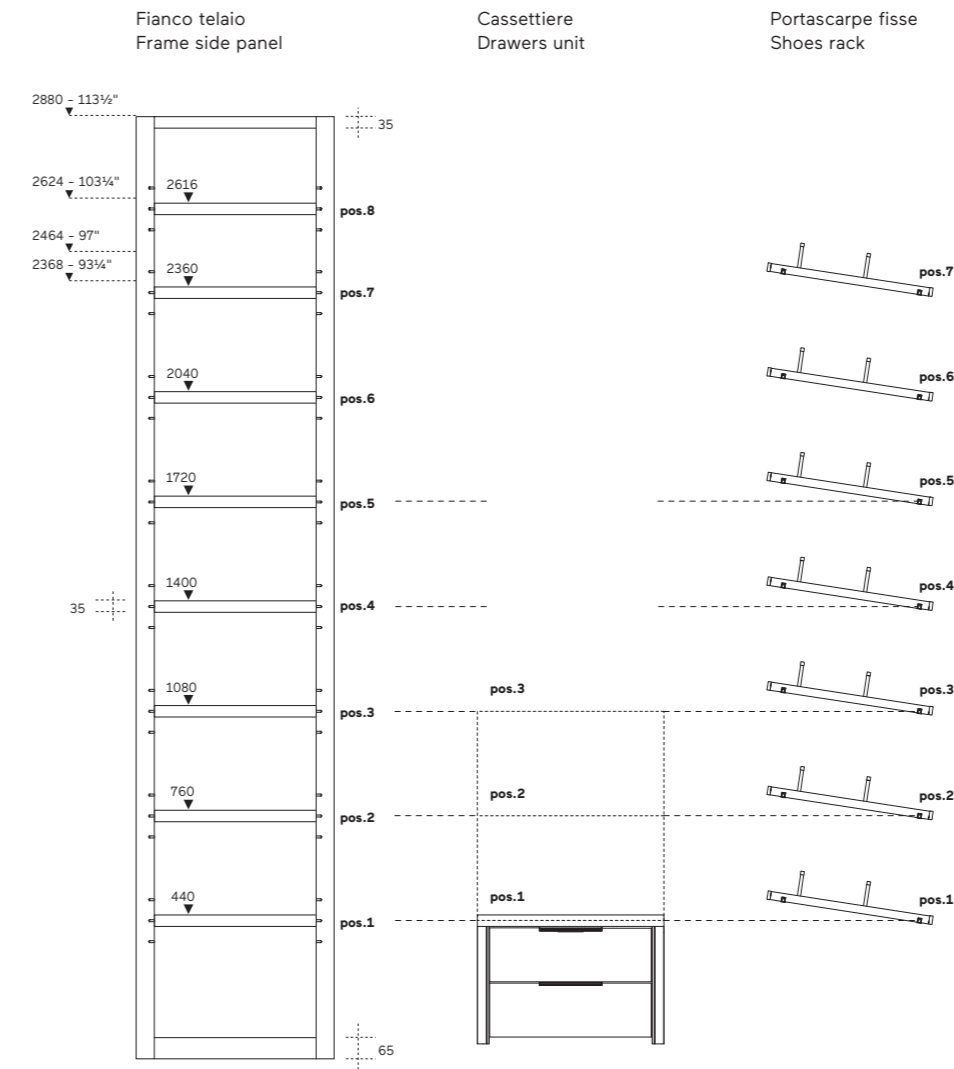

<p>Passo di foratura Drilling</p> <p>Il passo di foratura a 3 fori su fianco telaio è vincolato in specifiche posizioni non personalizzabili. Ogni attrezzatura è riposizionabile a +64 e -64 rispetto alle posizioni predefinite. Vedi disegno "pos. 1 - 2 - 3 - etc."</p> <p>The drilling pitch with 3 holes on the frame side is restricted to specific positions which cannot be customised. Each equipment can be repositioned at +64 and -64 from the predefined positions. See the drawing "pos. 1 - 2 - 3 - etc."</p>	<p>Posizioni Position</p> <p>Per l'alloggiamento delle attrezzature su fianco interno telaio o fianco esterno vetro, è necessario l'utilizzo di uno o due traversi di supporto secondo composizione</p> <p>One or two support traverses are required to fit equipment to internal frame side or external side panels in glass, depending on the composition</p>	<p>Attrezzatura disponibile Available equipment</p> <p>È possibile inserire le attrezzature descritte da pag. 164 a pag. 241 per realizzare tutte le combinazioni desiderate</p> <p>Equipment described from page 164 to page 241 can be fitted to enable you to find your desired combination</p> <p>Griglia portacamicie e fianco divisorio sono disponibili solo in presenza di fondale in melaminico</p> <p>Shirt rack and divider side are only available with the melamine back panel</p>	<p>Attrezzatura non disponibile Unavailable equipment</p> <p>Barra appendiabiti sezione tonda Servetto</p> <p>Hanger bar with round section Wardrobe lift</p>	<p>Nota Note</p> <p>Le strutture telaio non sono disponibili nella profondità 442 e per colonna terminale</p> <p>Frame structures not available for 442 depth wardrobe and terminal column</p>
--	--	--	--	---

Componibilità — Layouts

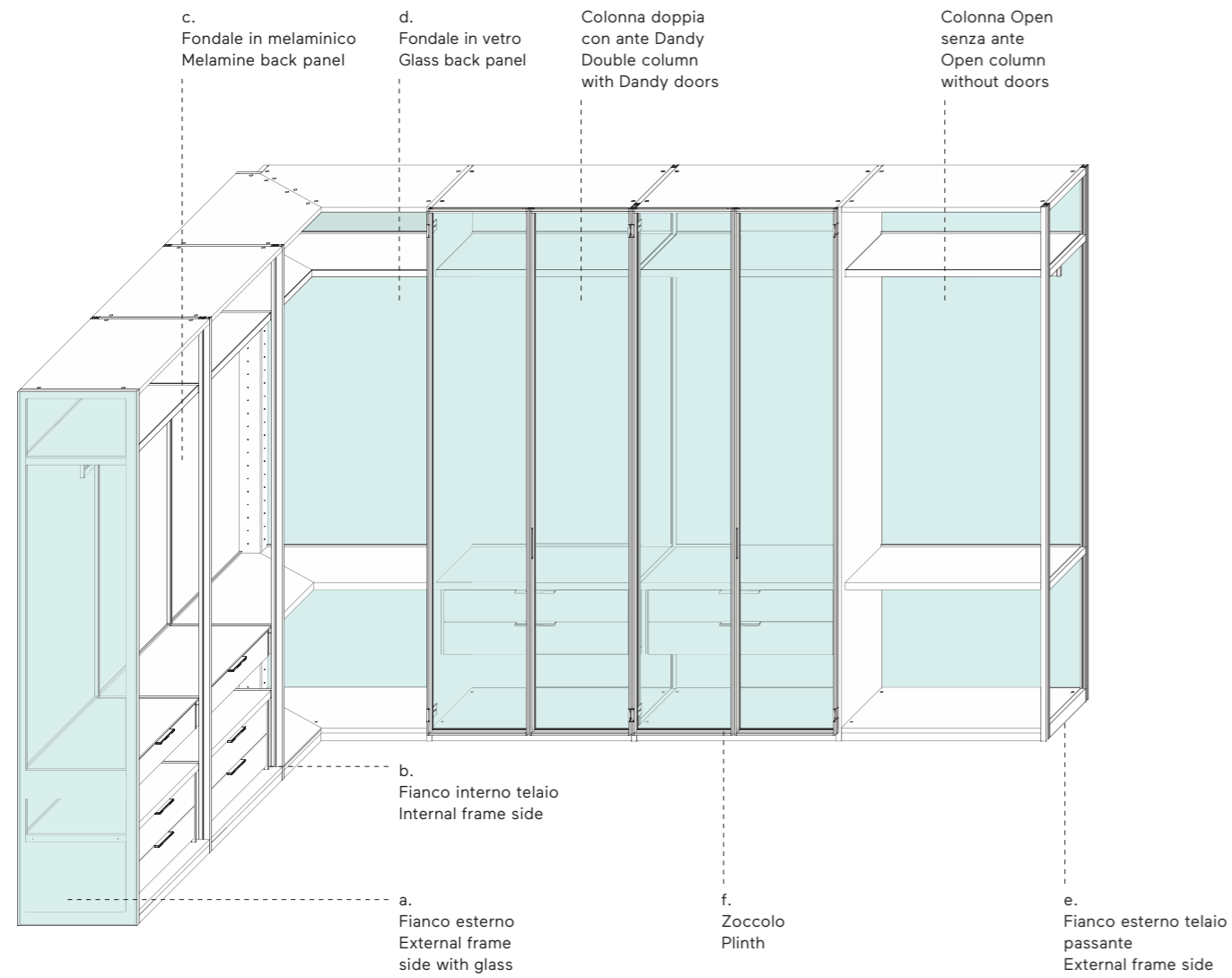

Descrizione componenti
Component description

- a. Fianco esterno vetro
 - b. Fianco interno telaio
 - c. Fondale in melaminico
 - d. Fondale in vetro
 - e. Fianco esterno telaio passante
 - f. Zoccolo
-
- a. External side in glass
 - b. Internal frame side
 - c. Back panel in melamine
 - d. Glass back panel
 - e. External frame side
 - f. Plinth



Cerniere — Hinges



Cerniera standard
Disponibile per ante battenti. Applicabile a colonne singole, doppie e ad angolo

Finiture
Bronzo
Nichel

Apertura 94° per colonne singole e doppie
Apertura 165° per colonne angolari
Apertura 135° per colonne terminali

Standard hinge
Available for hinged doors. Applicable to single, double and corner columns

Finishings
Bronze
Nickel

94° opening for single and double columns
165° opening for corner columns
135° opening for end columns

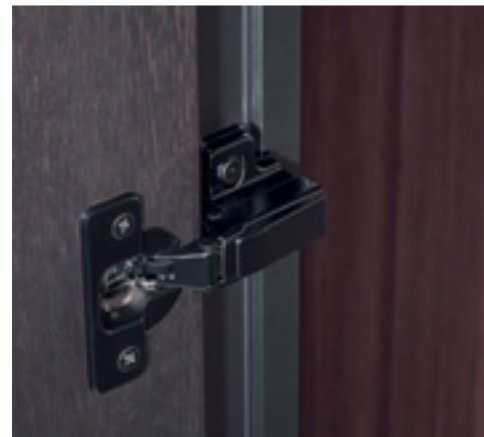

Cerniera speciale per fianco telaio
Disponibile per tutte le tipologie di ante battenti. Non disponibile per soluzioni ad angolo

Finiture
Bronzo
Nichel

Apertura 94°

Special hinge for frame side
Available for all types of hinged doors. Not available for corner solutions

Finishings
Bronze
Nickel

94° opening



Cerniera Dandy 120°
Disponibile solo per anta Dandy. Applicabile a colonne singole e doppie

Finiture
Metallo verniciato:
bronzo epox M421
sand epox M455

Apertura 120°

Dandy 120° hinge
Only available for Dandy doors. Applicable to single and double columns

Finishings
Metal painted:
bronze epox M421
sand epox M455

120° opening



Cerniera Dandy 180°
Disponibile per colonna angolare con anta Dandy. Su richiesta è disponibile anche per colonne singole e doppie con anta Dandy.

Finiture
Metallo verniciato:
bronzo epox M421
sand epox M455

Apertura 180°

Dandy 180° hinge
Available for Dandy angle column. Upon request also for single and double Dandy column

Finishings
Metal painted:
bronze epox M421
sand epox M455

180° opening

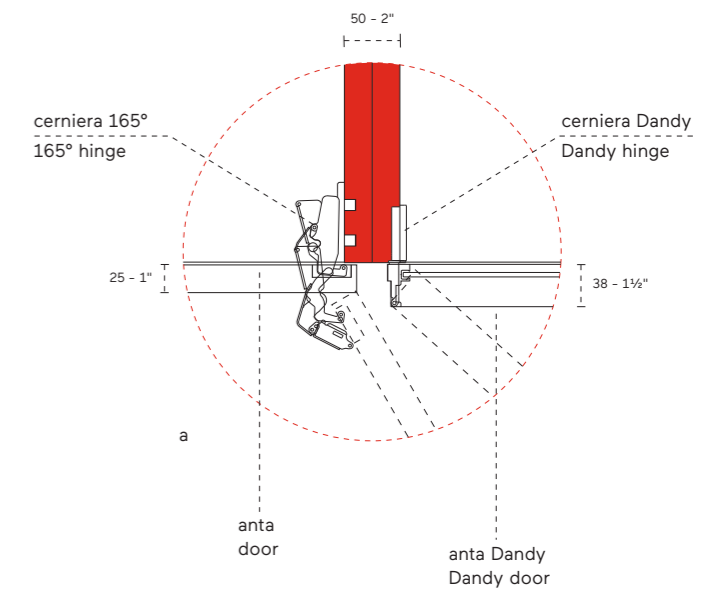
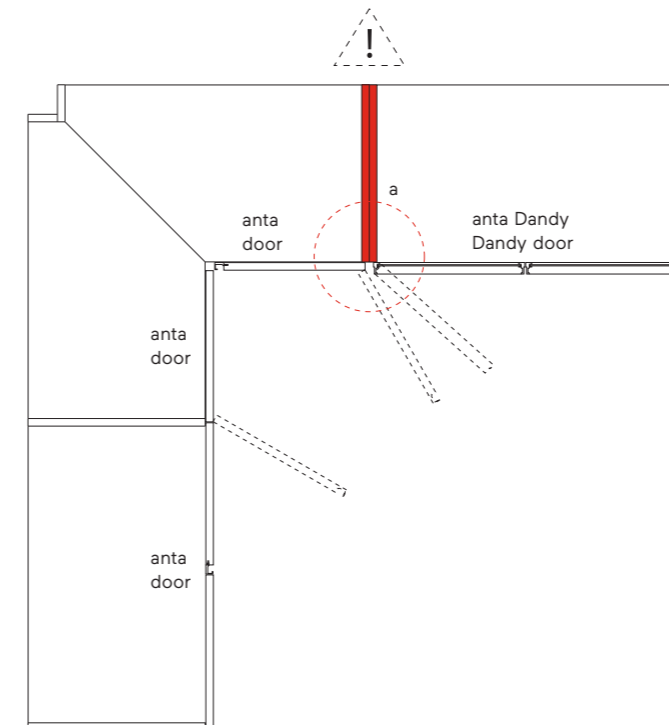
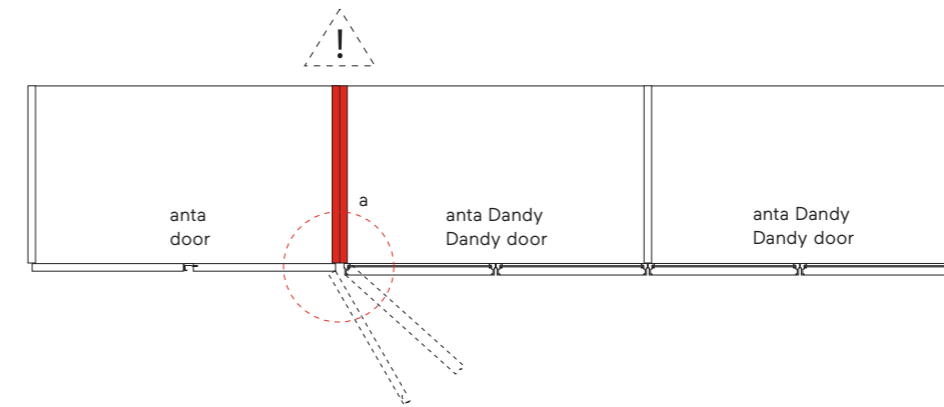

Cerniera standard 165° Standard hinge 165°

Su richiesta è possibile applicare la cerniera standard con apertura 165° anche sui vani singoli e doppi

Nel caso si scegliesse di accostare una colonna con ante con apertura 165° e una colonna con ante Dandy, sarà necessario prevedere il raddoppio del fianco interno per consentire l'apertura completa delle ante

Lema sconsiglia l'utilizzo di questo accostamento poiché due fianchi accostati generano uno spazio marcato tra le ante non conforme con l'estetica compositiva

By request, the standard hinge with 165° opening can be installed on single and double compartments

In the event that a column with 165° opening doors is combined with a column with Dandy doors, the internal side must be doubled up to ensure that the doors can open fully

Lema advises against this combination, because having two sides doubled up creates a noticeable space between the doors, with a negative impact on the aesthetics

Posizionamento cerniere — Hinges position

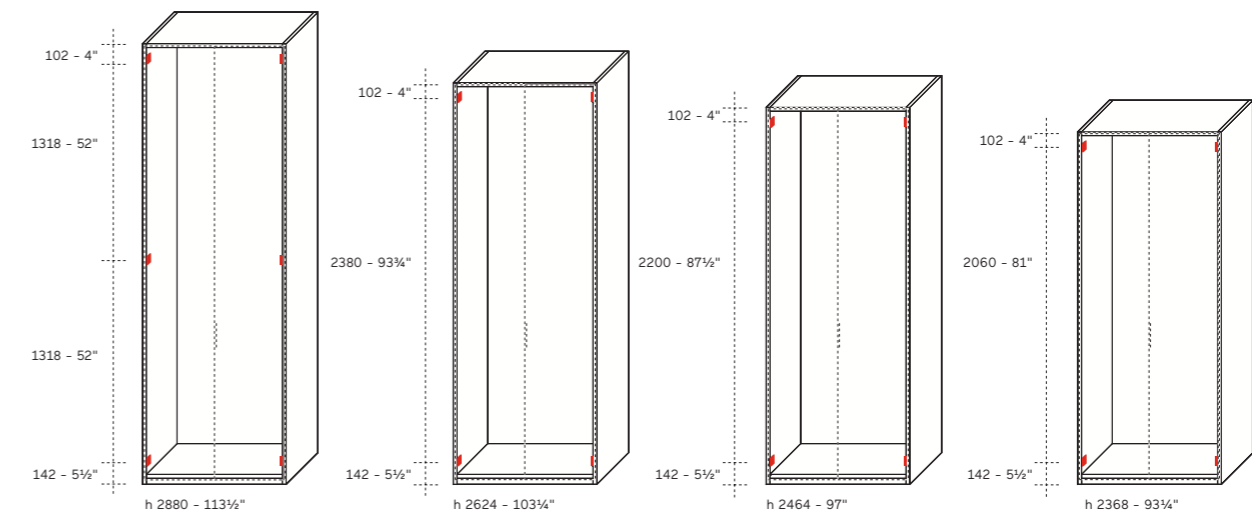
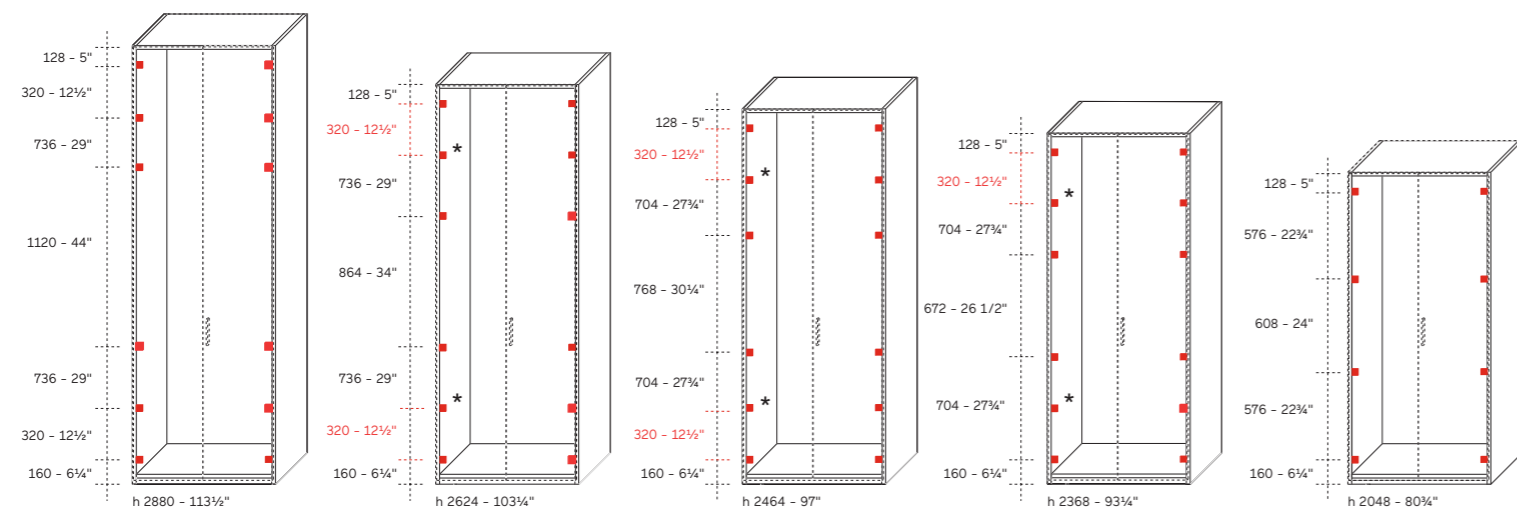

Cerniera standard Standard hinge

Apertura 94° per colonne singole e doppie
Apertura 165° per colonne angolari
Apertura 135° per colonne terminali

94° opening for single and double columns
165° opening for corner columns
135° opening for end columns

Cerniera speciale per fianco telaio Special hinged for frame side panel

Cerniera a chiusura rallentata a basso impatto dimensionale indispensabile per poter alloggiare l'anta in legno sul montante del fianco telaio.
Apertura 94° per colonne singole e doppie

Space-saving soft-close hinge required to fit the door on the upright of the frame side.
94° opening for single and double columns

Finiture Finishings

Il colore della cerniera segue la finitura del metallo presente all'interno dell'armadio.
Nichel - Metallo verniciato sand epox M455
Bronzo - Metallo verniciato bronzo epox M421

The color of the hinged follows the metal finishing present internally of the wardrobe.
Nikel - Metal sand epox painted M455
Bronze - Metal bronze epox painted M421

Altezza armadio Quantità cerniere Wardrobe height Hinge quantity

2048 - 80 3/4" - Nr.4
2368 - 93 1/4" - Nr.4
2464 - 97" - Nr.4
2624 - 103 3/4" - Nr.4
2880 - 113 1/2" - Nr.6

Nota Note

Per tutte le ante larghezza 592, montate su colonne altezza 2624, vengono installate nr. 6 cerniere

6 hinges must be used for all 592 width doors fitted on 2624 height columns

*

Cerniera aggiuntiva solo per ante: Emery, Warm, Seryasse

Additional hinge only for the following types of door: Emery, Warm, Seryasse

Cerniera Dandy 120° Dandy hinge

Cerniera pivot con riscontro magnetico di chiusura ammortizzata. Apertura 120° per colonne singole e doppie

Pivot hinge with magnetic soft-close system. 120° opening for single and double columns

Cerniera Dandy 180° Dandy hinge

Cerniera pivot con riscontro magnetico di chiusura ammortizzata. Apertura 180° per colonne ad angolo

Pivot hinge with magnetic soft-close system. 180° opening for corner columns

Finiture Finishings

Il colore della cerniera segue la finitura del metallo del profilo anta.
Metallo verniciato bronzo epox M421
Metallo verniciato sand epox M455

Hinges color matches doors profile.
Metal bronze epox painted M421
Metal sand epox painted M455

Altezza armadio Quantità cerniere Wardrobe height Hinge quantity

2368 - 93 1/4" - Nr.2
2464 - 97" - Nr.2
2624 - 103 3/4" - Nr.2
2880 - 113 1/2" - Nr.3

Nota Note

Su richiesta è possibile installare la cerniera con apertura 180° sulle colonne singole e doppie con anta Dandy. In tal caso per consentire l'apertura dei cassetti sarà necessario aprire l'anta alla massima rotazione

By request, the 180° opening hinge can be installed on single and double columns with Dandy door. In this case, to allow the drawers to be opened, the door must be opened to its maximum rotation

Foratura — Drilling



Passo foratura completa per fianco legno
Foratura standard.
Passo mm. 64.
Diametro fori a vista mm. 3

Complete drilling wood side
Standard hole.
Hole spacing 2½".
Hole diameter ¼"

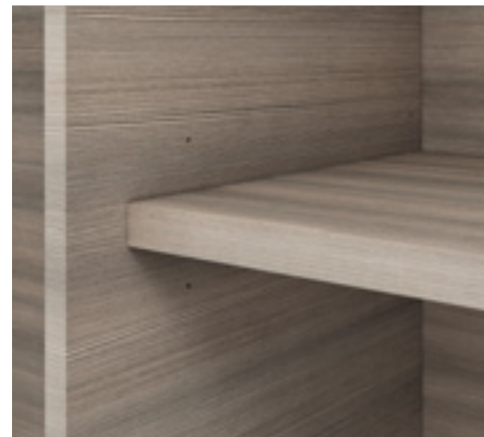

Passo di foratura 3 fori per fianco legno
Foratura su richiesta.
Passo mm. 64.
Diametro fori a vista mm. 3

3 holes drilling wood side
Drilling available on request.
Hole spacing 2½".
Hole diameter ¼"

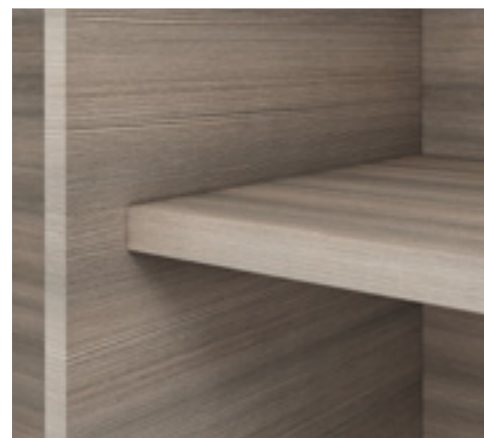

Passo di foratura personalizzata per fianco legno
Foratura su richiesta in corrispondenza delle attrezzature scelte

Custom drilling wood side
Drilling available on request in relation to the accessories selected



Passo di foratura per fianco telaio
Foratura 3 fori ad altezze predefinite non personalizzabili.
Dettagli a pag. 21

Drilling pitch frame side
Drilling pitch with 3 holes at a predetermined height, which cannot be customised.
Details on page 21

Dettagli struttura — Structure details



Profilo parapolvere
Montato su coperchi e basamenti.
Realizzato in coestruso di gomma trasparente

Dust-seal profile
Mounted on covers and bases.
Made of transparent, co-extruded rubber



Reggiripiano
Realizzato in metallo finiture bronzo o sand

Shelf supports
Made of bronze or sand finishings metal

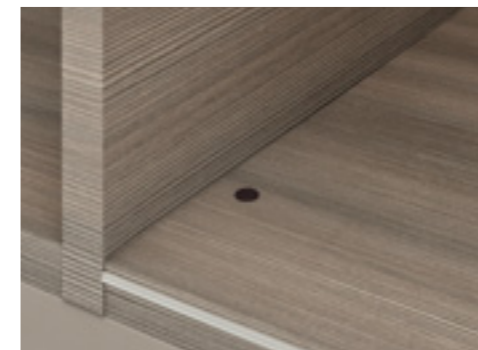

Base con foro di regolazione piedino
Il foro permette l'accesso alla regolazione del piedino, garantendo il livellamento di ogni colonna d'armadio.
Viene coperto con un tappino in materiale plastico nei colori bianco, talco, bronzo

Base with foot adjustment access
The hole allows access to foot adjustment to ensure that each column of the wardrobe is level.
It is covered with a plastic plug in white, talc or bronze



Profilo battanta per anta battente
Montato su anta battente è realizzato in coestruso di gomma, disponibile trasparente e traspirabile color bronzo

Door silencer profile for hinged door
Mounted on hinged door and made of coextruded rubber, available in transparent and transparent bronze color



Spazzola para-polvere anta scorrevole
Applicata su anta scorrevole, è disponibile nei colori nero o grigio

Brush dust-seal for sliding door
Applied to sliding door and available in white or grey

Riduzioni — Reductions

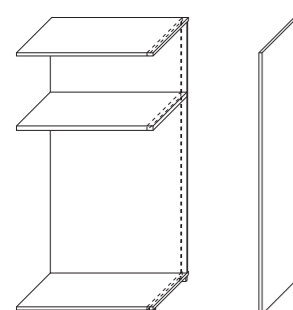

01

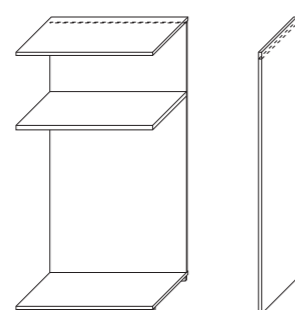

02

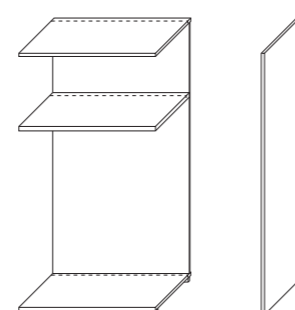

03

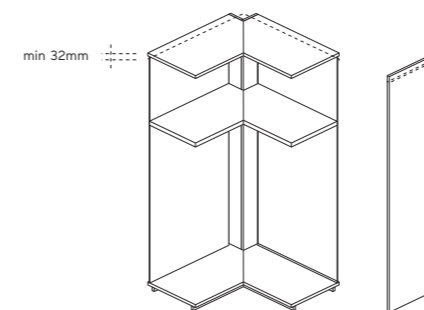

04

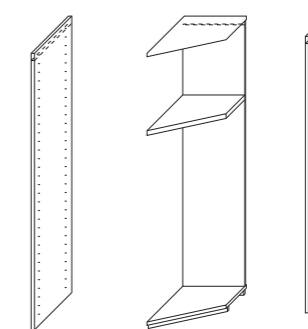

05

01

Riduzione in larghezza Width reduction

Possibile riduzione in larghezza a misura. Attrezzatura inseribile: ripiani o cassettiere speciali vedi pag. 218

The width can be reduced from minimum 1¼". Optional internal accessories: shelves or special drawer units See page 218

Ante riducibili* Reducible doors*

Prima
Flago
Text
Next
Elegant
Kyn
Ellevi
Naica
Nur
Emery
Dandy

02

Riduzione in altezza Height reduction

Possibile riduzione in altezza a misura. The height can be reduced from minimum 1¼"

Ante riducibili Reducible doors

Prima
Flago
Text
Next
Elegant
Kyn
Ellevi
Naica
Nur
Emery
Dandy
Seryasse

03

Riduzione struttura e fianchi in profondità Column and side panels depth reduction

Possibile riduzione in profondità con passo iniziale mm. 21 e poi su misura. Attrezzatura inseribile: ripiani e cassettiere. Riduzione massima cassettiere fino a mm. 340. Riduzione massima fianco fino a mm. 235

The depth can be reduced, initially by ¾" and then according to the dimension required. Optional Internal accessories: shelves and drawers. Drawer unit can be reduced by up to 13½". Side element can be reduced by up to 9¼"

04

Riduzione per colonne ad angolo** Corner column reduction**

Possibile riduzione in altezza a misura

The height can be reduced from minimum 1¼"

Ante riducibili Reducible doors

Prima
Flago
Text
Next
Elegant
Kyn
Ellevi
Naica
Nur
Emery

05

Riduzione per colonne terminali End column reduction

Possibile riduzione solo in altezza a misura

The height can be reduced from minimum 1¼"

Ante battenti riducibili Reducible hinged doors

Prima
Flago
Text
Next
Elegant
Kyn
Ellevi
Emery

Nota Note

Ogni composizione su misura verrà valutata, applicando dove possibile le riduzioni richieste

Each customized composition will be evaluated and applicated where possible

* Riduzione massima ante scorrevole fino a mm. 750

Maximum reduction for sliding door up to 29½"

** La dimensione di riduzione in profondità dovrà essere uguale per entrambi i lati della colonna angolare

The reduction in depth must be the same for both sides of the corner column

Pannelli d'ispezione — Access Panel

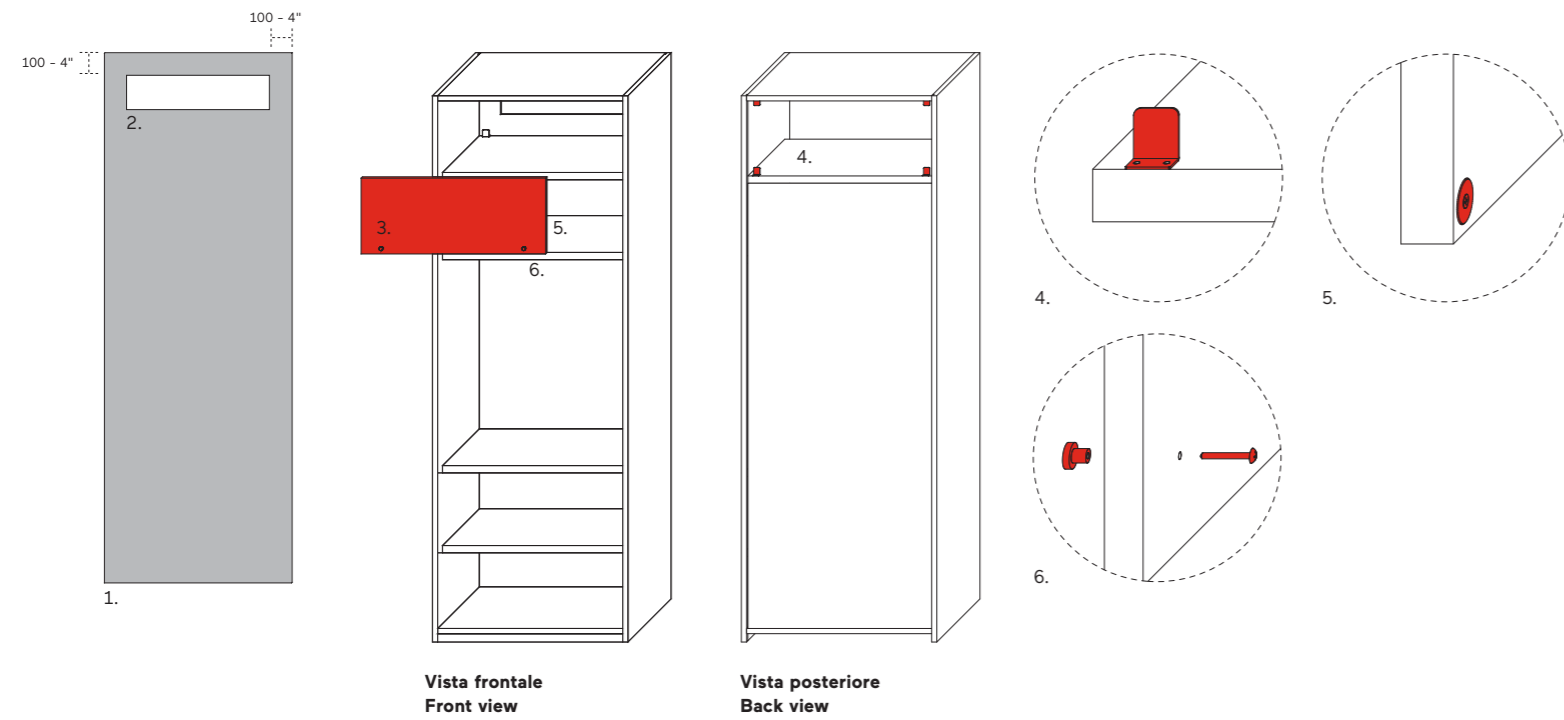

Vista frontale
Front view

Vista posteriore
Back view

**Tipologia 1 —
Ispezione su fondale
Type 1 —
Access panel at the back**

- | | |
|---|--|
| 1. Fondale spessore 8 | 1. Back panel thickness 8 |
| 2. Taglio su fondale senza bordatura | 2. Cut-out on back panel without border |
| 3. Pannello removibile larghezza colonna, spessore 19 con bordatura 4 lati | 3. Column-width removable panel, thickness 19 with border on 4 sides |
| 4. Squadretta angolare per fissaggio pannello. Posizionabile alla profondità desiderata | 4. Square bracket for securing the panel. Can be positioned at desired depth |
| 5. Magnete diametro 20 | 5. Magnet diameter 20 |
| 6. Apertura tramite pomolo verniciato bronzo | 6. Opening via bronze-painted knob |

**Nota
Note**
Ogni richiesta verrà valutata dal nostro ufficio tecnico per confermarne la fattibilità

All requests will be assessed by our Technical Department to gauge their feasibility

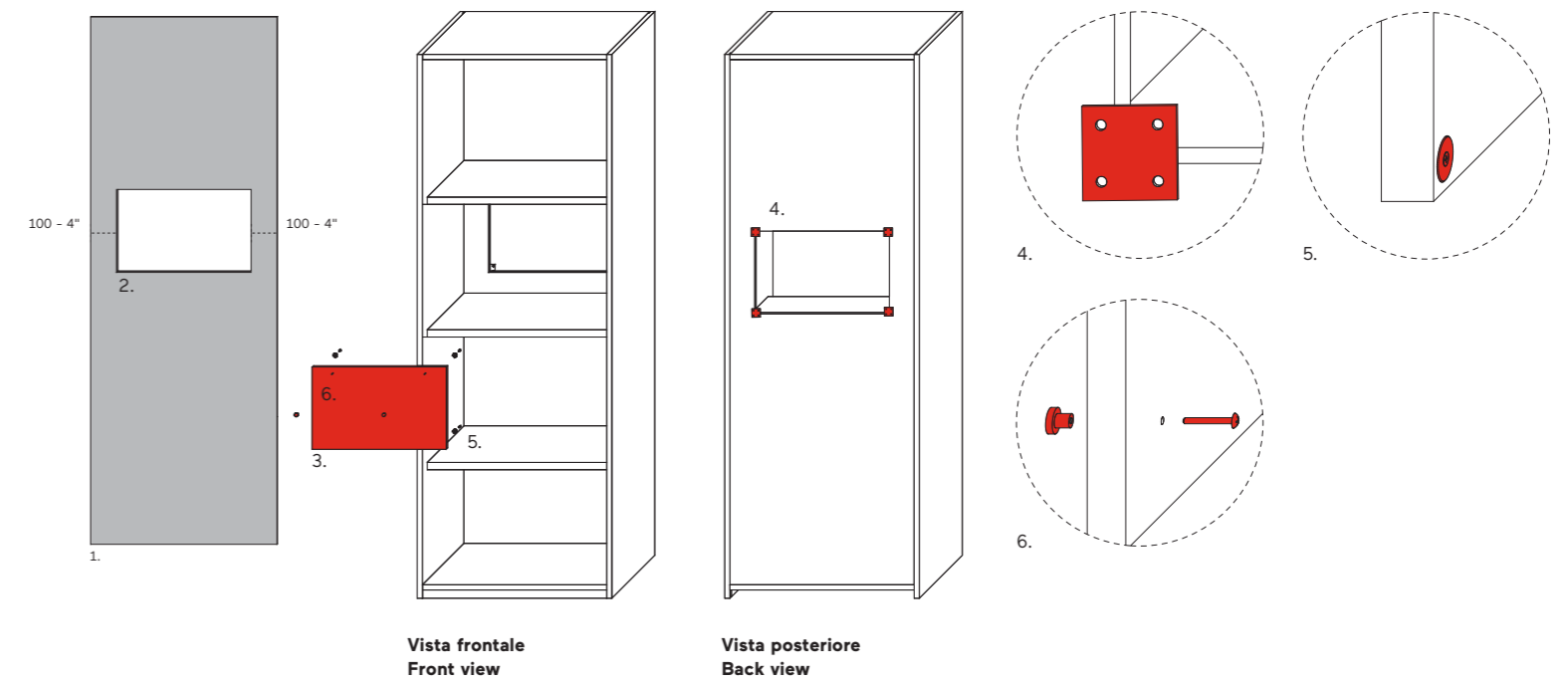

Vista frontale
Front view

Vista posteriore
Back view

**Tipologia 2 —
Ispezione su fondale
Type 2 —
Access panel at the back**

- | | |
|---|---|
| 1. Fondale spessore 19 | 1. Back panel thickness 19 |
| 2. Taglio a misura su fondale bordatura 4 lati | 2. Bespoke cut-out on back panel with border on 4 sides |
| 3. Pannello removibile a misura, spessore 19 con bordatura 4 lati | 3. Bespoke removable panel, thickness 19 with border on 4 sides |
| 4. Piastra metallica 40x40 per ancoraggio pannello | 4. 40x40 metal plate for securing the panel |
| 5. Magnete diametro 20 | 5. Magnet diameter 20 |
| 6. Apertura tramite pomolo verniciato bronzo | 6. Opening via bronze-painted knob |

**Nota
Note**
Ogni richiesta verrà valutata dal nostro ufficio tecnico per confermarne la fattibilità

All requests will be assessed by our Technical Department to gauge their feasibility

Pannelli d'ispezione — Access Panel

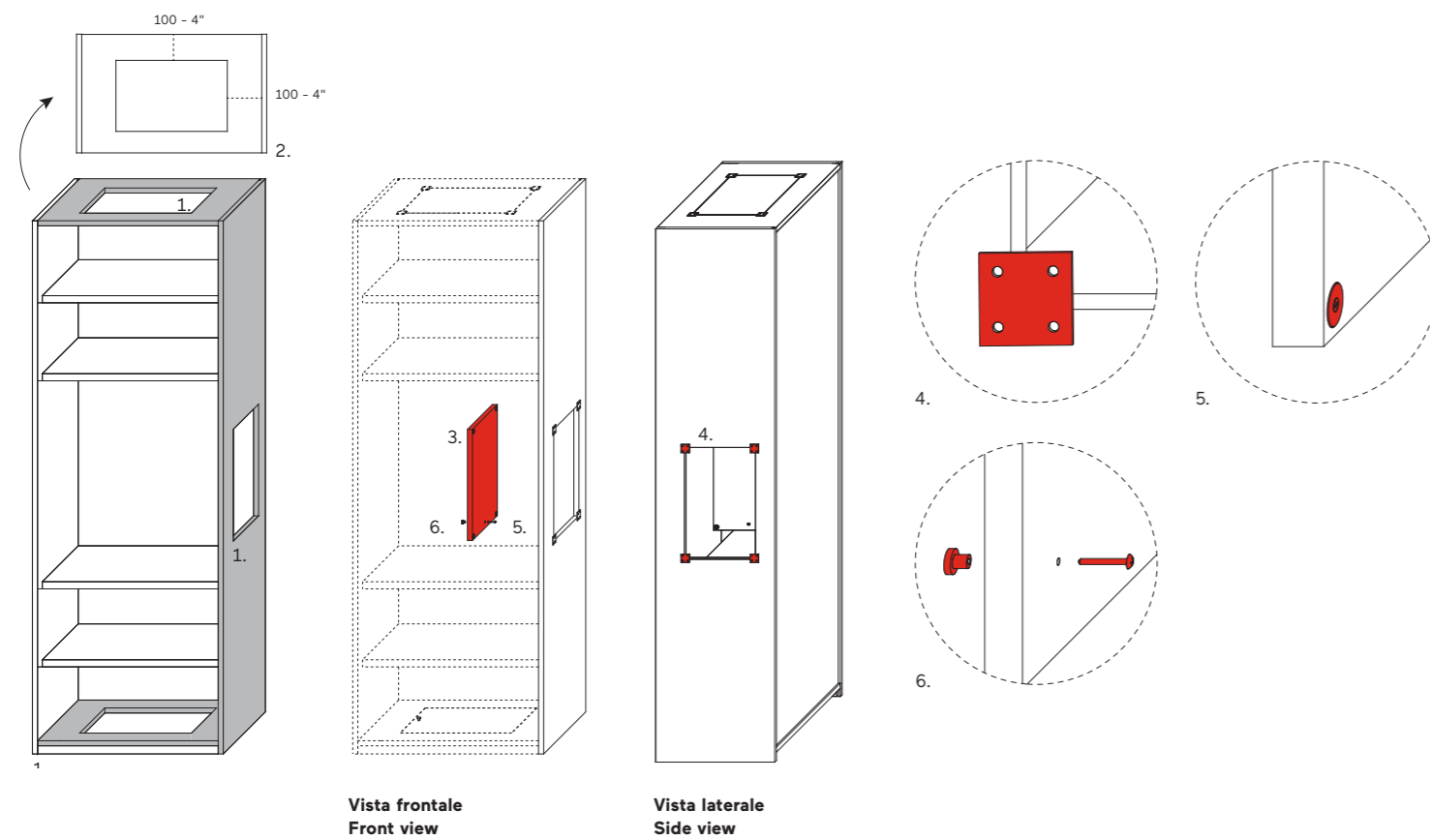

Vista frontale
Front view

Vista laterale
Side view

Tipologia 3 — Ispezione su basamento, fianco, coperchio

Type 3 — Access panel on base, side and top

1. Taglio su basamento, fianco e coperchio con bordatura 4 lati
2. Spazio minimo necessario bordo
3. Pannello removibile spessore 25 con bordatura 4 lati
4. Piastra metallica 40x40 per ancoraggio pannello
5. Magnete diametro 20
6. Apertura tramite pomolo verniciato bronzo

1. Cut-out on base, side and top with border on 4 sides
2. Minimum space required for border
3. Removable panel, thickness 25 with border on 4 sides
4. 40x40 metal plate for securing the panel
5. Magnet diameter 20
6. Opening via bronze-painted knob

Informazioni utili Useful information

Ispezione su basamento Access panel on base

Per colonna 1165 considerare profondità massima pannello 320

Ispezione su fianco Access panel on side

In presenza di foratura continua: dim. minima bordo anteriore 120 dim. minima bordo posteriore 100

In presenza di Air Cleaning system: altezza interruttore da terra 1152

Access panel on base Access panel on top

For column 1165 consider a maximum panel depth of 320

Access panel on side

In presence of continuous drilling: minimum front border dim. 120, minimum rear border dim. 100

With Air Cleaning System: Height of switch from the floor 1152

Ispezione su coperchio Access panel on top

Per armadio scorrevole, in presenza del binario: dim. massima pannello 200x200

Per armadio complanare, in presenza del binario: non è possibile l'inserimento del pannello removibile

For sliding wardrobe, including rail: maximum panel dim. 200x200

For coplanar wardrobe, including rail: no removable panel can be fitted

Nota Note

Ogni richiesta verrà valutata dal nostro ufficio tecnico per confermarne la fattibilità

All requests will be assessed by our Technical Department to gauge their feasibility

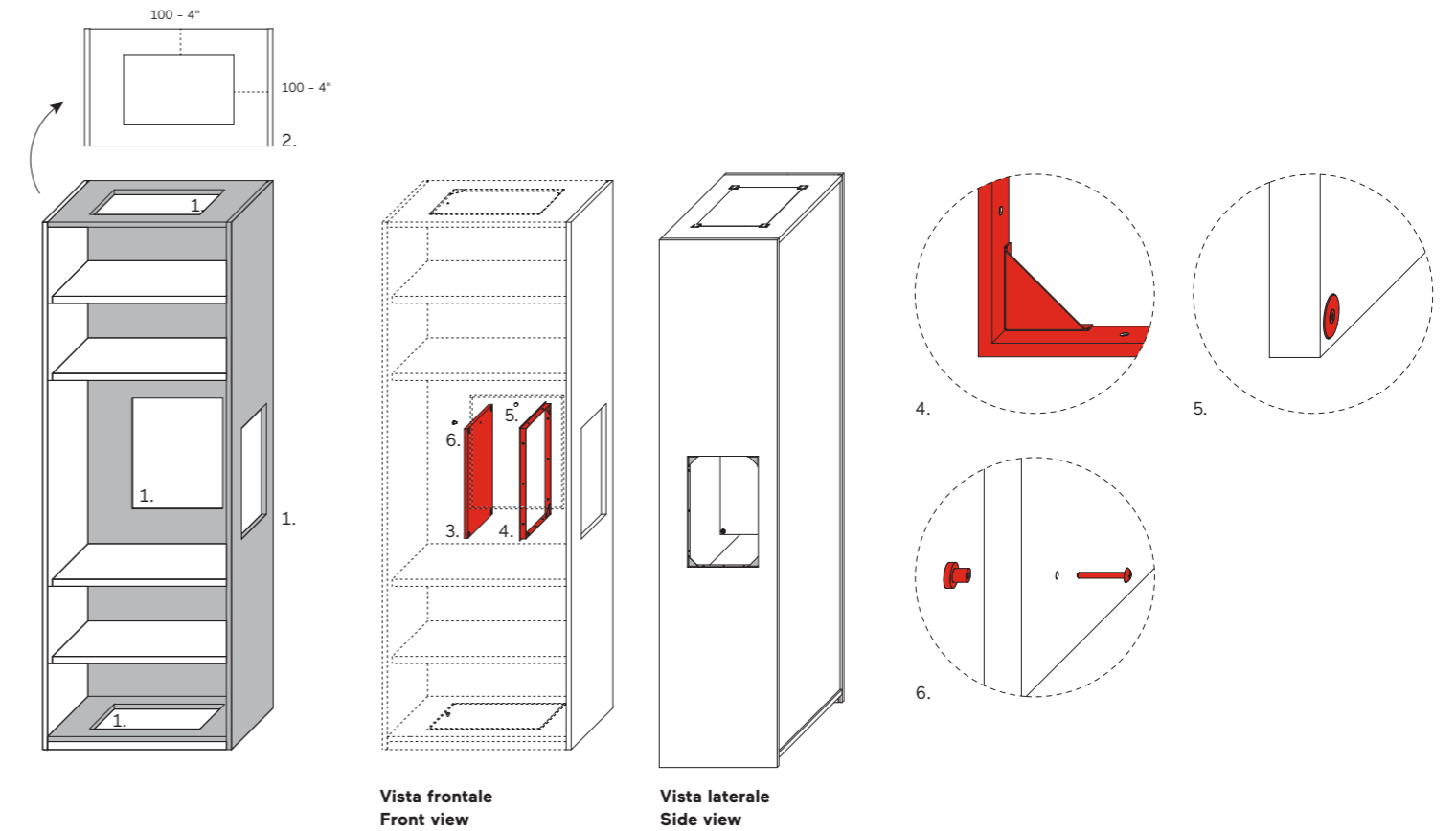

Vista frontale
Front view

Vista laterale
Side view

Tipologia 4 — Ispezione su basamento, fianco, coperchio e fondale

Type 4 — Access panel on base, side and top

1. Taglio su basamento, fianco, coperchio e fondale spessore 8 con bordatura 4 lati
2. Spazio minimo necessario bordo
3. Pannello removibile spessore 19 con bordatura 4 lati
4. Telaio metallo verniciato bronzo
5. Magnete diametro 20
6. Apertura tramite pomolo verniciato bronzo

1. Cut-out on base, side, top and back panel 8 mm thick with border on 4 sides
2. Minimum space required for border
3. Removable panel, thickness 19 with border on 4 sides
4. Metal frame painted bronze
5. Magnet diameter 20
6. Opening via bronze-painted knob

Informazioni utili Useful information

Ispezione su basamento Access panel on base

Per colonna 1165 considerare profondità massima pannello 320

Ispezione su fianco Access panel on side

In presenza di foratura continua: dim. minima bordo anteriore 120 dim. minima bordo posteriore 100

In presenza di Air Cleaning system: altezza interruttore da terra 1152

Access panel on base Access panel on top

For column 1165 consider a maximum panel depth of 320

Access panel on side

In presence of continuous drilling: minimum front border dim. 120, minimum rear border dim. 100

With Air Cleaning System: height of switch from the floor 1152

Ispezione su coperchio Access panel on top

Per armadio scorrevole, in presenza del binario: dim. massima pannello 200x200

Per armadio complanare, in presenza del binario: non è possibile l'inserimento del pannello removibile

For sliding wardrobe, including rail: maximum panel dim. 200x200

For coplanar wardrobe, including rail: no removable panel can be fitted

Nota Note

Ogni richiesta verrà valutata dal nostro ufficio tecnico per confermarne la fattibilità

All requests will be assessed by our Technical Department to gauge their feasibility

Lavorazioni speciali — Special manufacturing

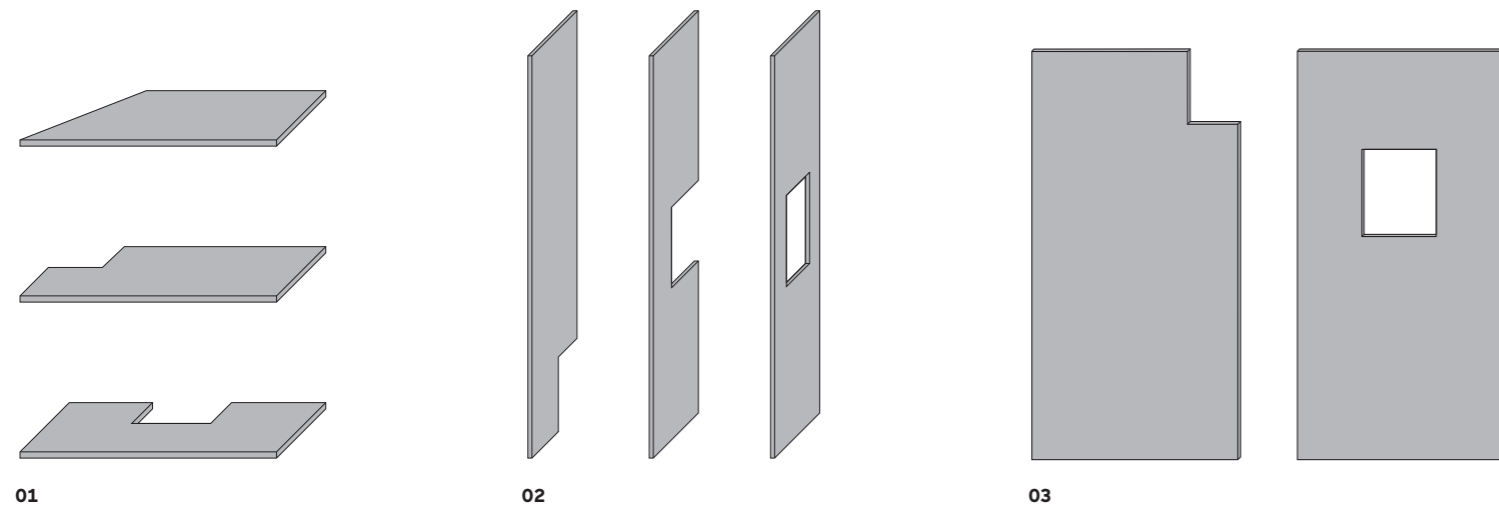

In presenza di vincoli architettonici o strutturali è possibile realizzare tagli su misura su:

- 01. basi, coperchi, ripiani
- 02. fianchi
- 03. fondali

Where architectural or structural restrictions are present, bespoke cut-outs can be fitted on:

- 01. bases, tops and shelves
- 02. sides
- 03. back panels

Nota
Note
Ogni lavorazione è comprensiva di bordatura e verrà valutata dal nostro ufficio tecnico per soddisfare dove possibile le personalizzazioni richieste

All interventions include borders and will be assessed by our Technical Department, which aims to accommodate as many customisation requests as possible



01
Esempio 1
Example 1

Taglio su fianco, base, fondale in presenza di vincoli architettonici

Cut-out on side, base and back panel where architectural restrictions are present

02
Esempio 2
Example 2

Taglio su fondale per richieste personalizzate

Cut-out on back panel for customised requests

Fasce di chiusura — Filler panels

Fascia con guarnizione
With rubber profile

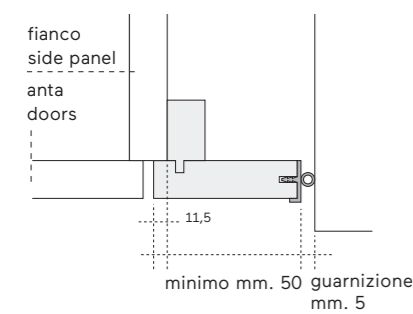

Sezione orizzontale
soluzione battente

Horizontal section
hinged version

Fascia senza guarnizione
Without rubber profile

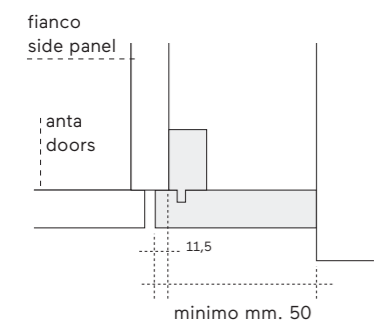

01

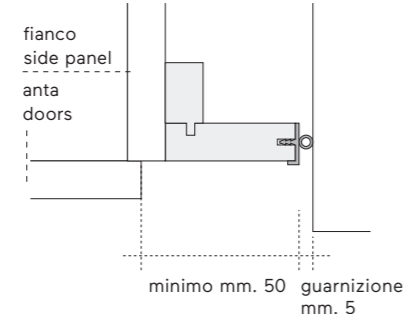

Sezione orizzontale
soluzione battente,
scorrevole, complanare

Horizontal section
hinged, sliding,
coplanar version

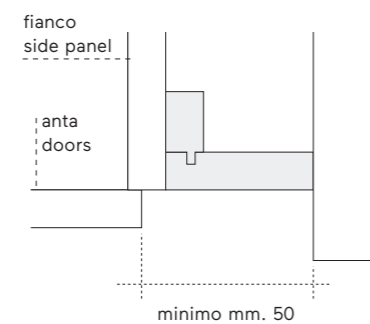

02

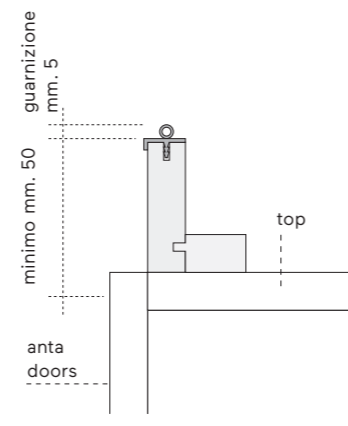

Sezione orizzontale
soluzione battente

Horizontal section
hinged version

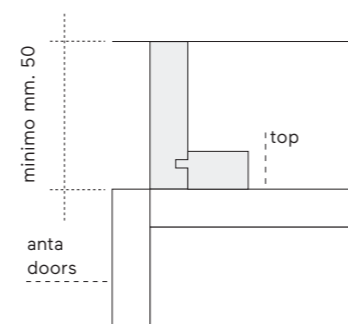

03

01

Fascia di chiusura laterale a filo anta
Side filler panel flush to the door

Larghezza
Width
da 50 a 250
from 2" to 9¾"

Altezza
Height
3000**
118"

Spessore
Thickness
19* - 25 - 30
¾" - 1" - 1¼"

02

Fascia di chiusura laterale a filo fianco
Side filler panel flush to the side panel

Larghezza
Width
da 50 a 250
from 2" to 9¾"

Altezza
Height
3000**
118"

Spessore
Thickness
19* - 25 - 30
¾" - 1" - 1¼"

03

Fascia di chiusura superiore a filo coperchio
Upper filler panel flush to the top

Altezza
Height
da 50 a 250
from 2" to 9¾"

Lunghezza
Length
3000**
118"

Spessore
Thickness
19* - 25 - 30
¾" - 1" - 1¼"

Finiture per tutte le fasce 01-02-03
Finishings for all the filler panels 01-02-03
Melaminico*
Laccato LCT o LCL
Rovere carbone
Rovere grigio
Rovere termotrattato
Noce L

Lacquered LCT or LCL
Oak carbone
Oak grey
Oak heat-treated
L-walnut

Nota
Note

Le fasce di chiusura sono riducibili in altezza e larghezza

The filler panels can be reduced in height and width

*

Fascia spessore 19 disponibile solo in melaminico
Side filler thickness ¾" available only in melamine

**

Melaminico Gobi e Sahara:
Altezza massima 2900
Lunghezza massima 2040 Gobi e Sahara

Gobi and Sahara melamine:
Maximum height 114¼"
Maximum length 80¾"
2040 Gobi and Sahara

Fascia con guarnizione
With rubber profile



Fascia senza guarnizione
Without rubber profile



Fascia di chiusura laterale a filo anta
Posizionata in linea con le ante ed installata sui fianchi esterni dell'armadio, consente la massima linearità della facciata nelle soluzioni in nicchia

Vertical filler panel flush with door
Flush with doors and installed on external wardrobe sides, it draws a perfect linear facade in niche proposals

Fascia di chiusura laterale a filo fianco
Arretrata rispetto all'anta e installata sui fianchi esterni dell'armadio, consente di creare con una soluzione formalmente pura un cambio piano di grande effetto grafico

Vertical filler panel flush with side panel
Step back compared to doors and installed on wardrobe external side panels, it allows to create a level change though a pure design solution

Fascia di chiusura superiore a filo coperchio
Predisposta per fissaggio sul coperchio, consente di compensare lo spazio in altezza tra l'armadio ed il soffitto

Horizontal filler panel flush with cover
Compatible to be fixed on wardrobe cover, it fills the space up between wardrobe and ceiling



Soluzioni particolari — Particular solutions

Sistema componibile che offre massima libertà compositiva grazie all'ampia gamma di moduli disponibili e alla possibilità di tagli secondo le dimensioni desiderate, in altezza, larghezza e profondità. Possibilità inoltre di avere soluzioni speciali che prevedono angoli, terminali, ponti, passaggi sopraporta, nicchie, cassettiere a vista sulla facciata e tagli a mansarda realizzati su progetto. Tutte le soluzioni speciali vengono realizzate in svariate finiture che spaziano, a seconda della tipologia di anta e apertura, dai laccati opachi Lemacolortrend, ai laccati Lemacolorlucido, a legni, vetri, tessuti, con alcune limitazioni.

Modular system offering maximum freedom of composition thanks to a wide range of available modules and the option to alter the height, width and depth of modules as desired. There are also bespoke solutions including corners, end units, bridging units, overdoor units, niches, open-faced drawer units and attic pieces made to measure. All our bespoke solutions are offered in a range of different finishings including Lemacolortrend matt lacquer to Lemacolorlucido glossy lacquer, wood, glass and fabric, depending on the type of door and opening system (some restrictions apply).

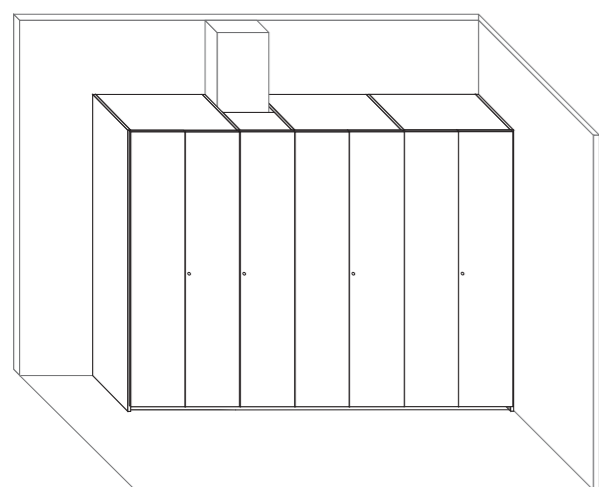

01
Cambio di profondità per presenza di vincoli architettonici
Depth variation to accommodate architectural restriction
Anta battente
Anta scorrevole
Anta complanare

Hinged door
Sliding door
Coplanar door

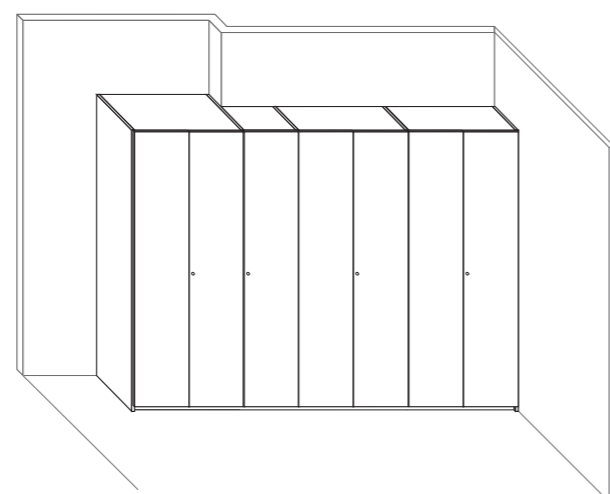

02
Cambio di profondità
Depth variation
Anta battente
Anta scorrevole
Anta complanare

Hinged door
Sliding door
Coplanar door

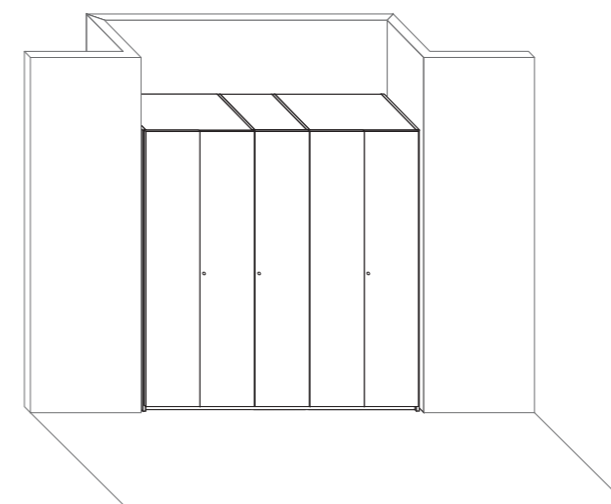

03
Armadio in nicchia
Wardrobe in recess
Anta battente
Anta scorrevole
Anta complanare

Hinged door
Sliding door
Coplanar door

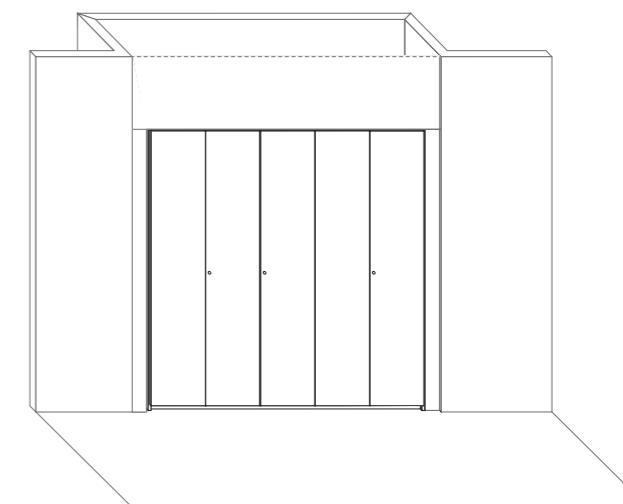

04
Armadio in nicchia con chiusure laterali e superiori
Wardrobe in recess with horizontal and lateral fillers

Anta battente
Anta scorrevole
Anta complanare

Hinged door
Sliding door
Coplanar door

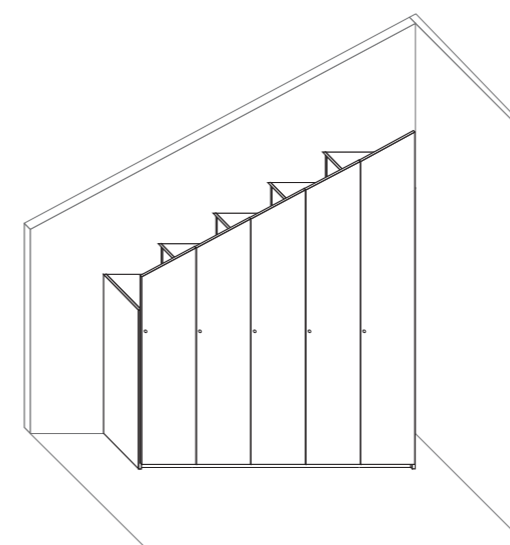

05
Soluzione per mansarda
Solution for attic
Anta battente
Hinged door

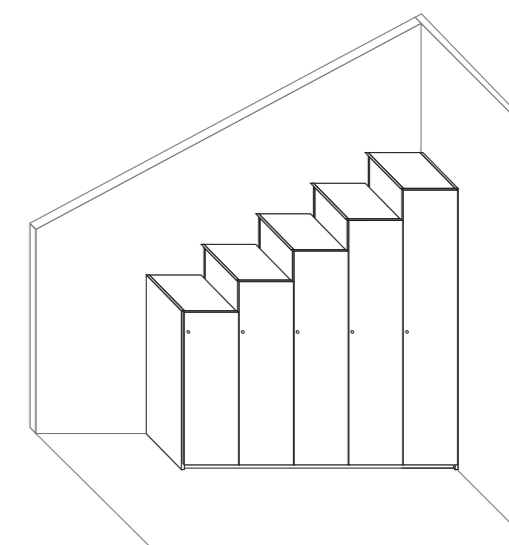

06
Soluzione a scaletta per mansarda
Stair solution for attic
Anta battente
Hinged door

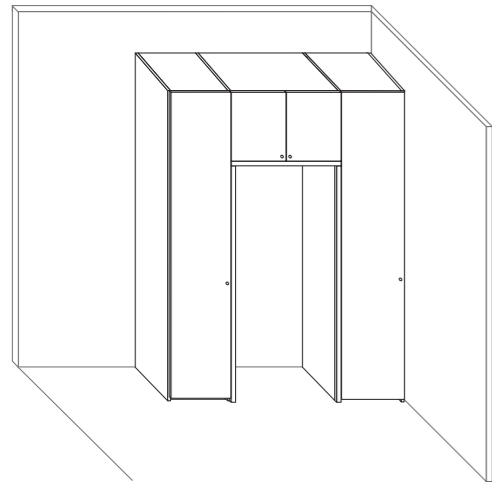

07

Soluzione passaggio porta
Door passage solution
 Anta battente
 Hinged door

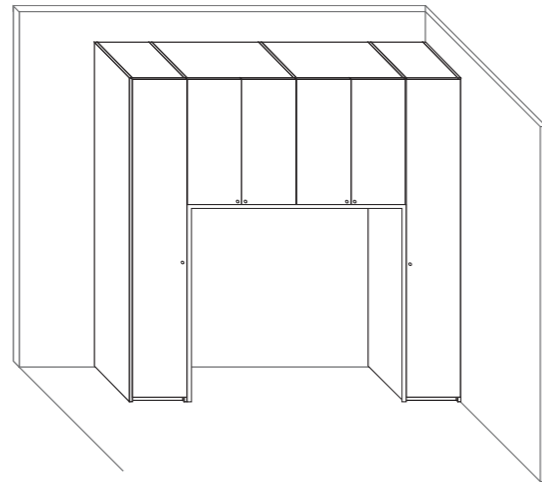

08

Soluzione a ponte
Bridging solution
 Anta battente
 Hinged door

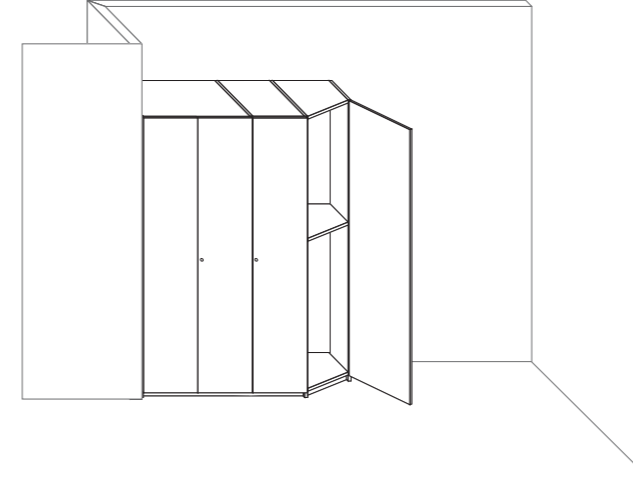

10

Armadio con elemento terminale
Wardrobe with end element
 Anta battente
 Hinged door

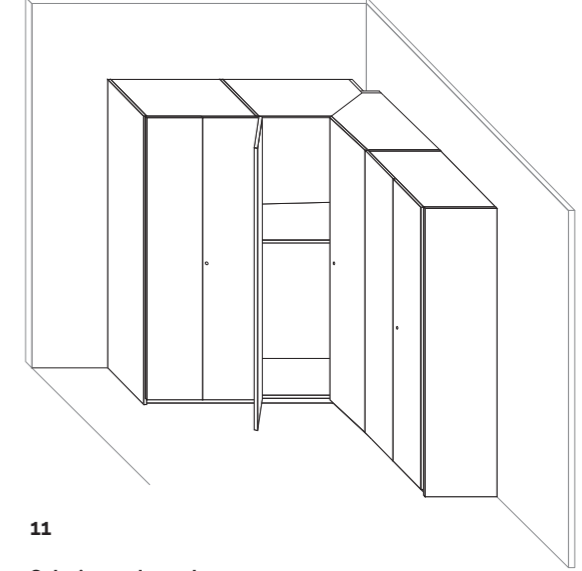

11

Soluzione ad angolo
Corner solution
 Anta battente
 Hinged door

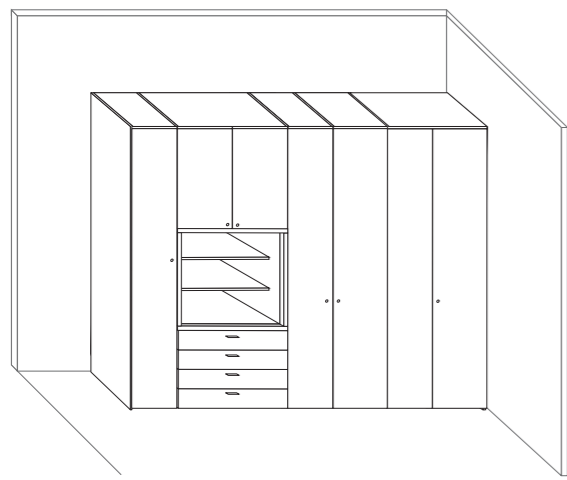

09

Soluzione con vano e cassettera a vista
Solution with open cabinet and drawer unit
 Anta battente
 Hinged door

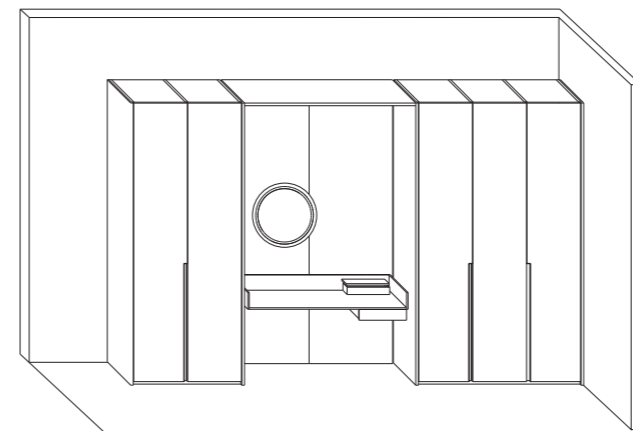

12

Soluzione armadio con LT40 Vanity
Wardrobe with LT40 vanity solution
 Anta battente
 Armadio Open
 Hinged door
 Open wardrobe

Vanity LT40

Prezioso oggetto di design, ricco di contenuti formali e funzionali, dettagli di ebanisteria e pratiche soluzioni per una quotidianità intima e personale. David Lopez Quinconces, firma non soltanto un progetto ma un nuovo e inedito dialogo fra LT FRAME e Armadio al Centimetro. VANITY trasforma un prodotto in uno spazio, un luogo raffinato e avvolgente per il make up, un luogo discreto e appartato per lo smart working, ma anche lo scrigno dei propri ricordi e degli oggetti più cari.

This stunning designer piece combines both form and function, with the finest cabinetwork underpinned by practical solutions for a personalised experienced. David Lopez Quinconces has created not just a project, but a new and original relationship between LT FRAME and the Armadio al Centimetro system. VANITY transforms a product into a space, a refined and welcoming place for make-up, a discreet and reserved space for smart working, but also a treasure chest of one's memories and precious possessions.



Componenti — Components

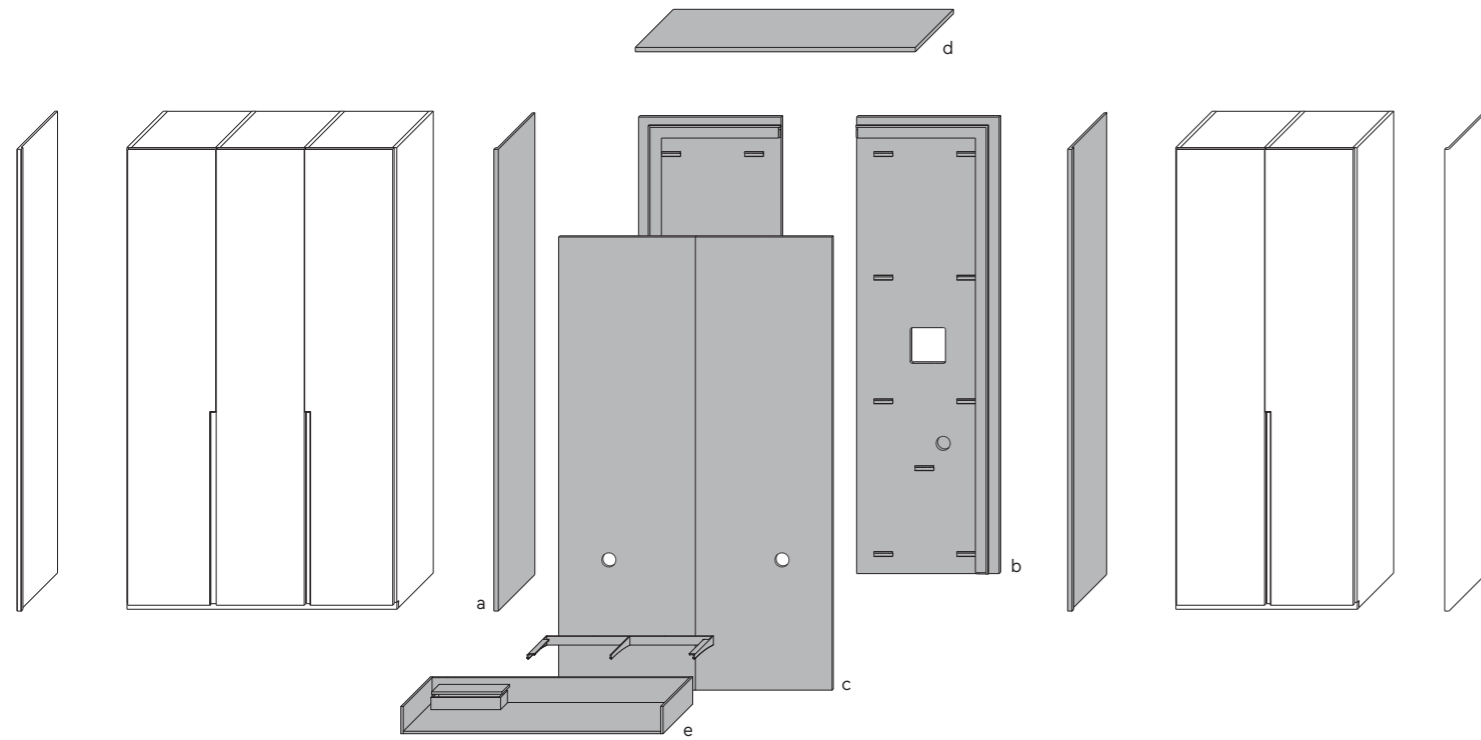

Componenti struttura Structure components	Finitura Finishing	Scrittoio Desk	Riduzioni Reduction	Nota Note
a. Fianco esterno (standard o di finitura)	Fianco, pannello boiserie, coperchio Sides, boiserie panelling, top	Laccato opaco LCT Rovere termotrattato Noce-L	Possibile riduzione in altezza a misura	Possibilità di fissaggio scrittoio direttamente a muro senza pannelli boiserie
b. Telaio con pannello e luce led integrata		Matt lacquered LCT Heat-treated oak Walnut-L	Height can be reduced as required	
c. Pannelli boiserie				
d. Coperchio				
e. Scrittoio				
a. External side (standard or finishing)	Laccato opaco LCT Laccato lucido LCL Rovere carbone Rovere termotrattato Rovere grigio Noce-L			
b. Frame with panel and integrated LED light				
c. Boiserie panelling				
d. Top	Matt lacquered LCT Glossy lacquered LCL Carbone oak Heat-treated oak Grey oak Walnut-L			
e. Desk				

Struttura — Structure

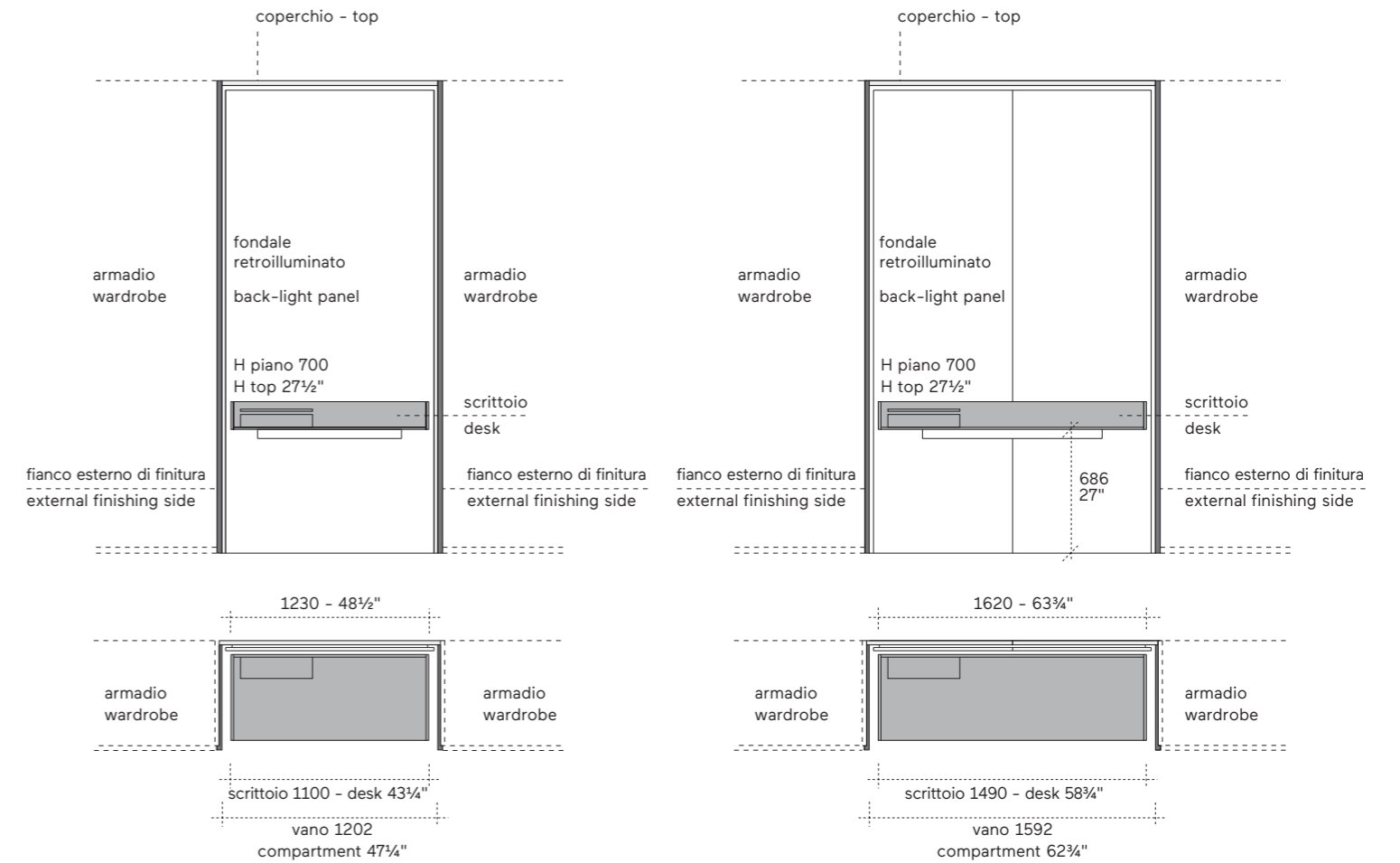

Fianco esterno di finitura External finishing side	Fianco esterno standard External standard side	Pannello boiserie Boiserie panelling	Coperchio Top	Profondità per fianco esterno standard Standard external side
Spessore Thickness 39 1 1/2"	Spessore Thickness 25 1"	Larghezza per vano 1202 Compartment width 1202 1164 45 3/4"	Spessore Thickness 25 1"	Profondità per fianco esterno standard Standard external side width 585 23"
Altezza Height 2368 - 2464 - 2624 - 2880 93 3/4" - 97" - 103 3/4" - 113 1/2"	Altezza Height 2368 - 2464 - 2624 - 2880 93 3/4" - 97" - 103 3/4" - 113 1/2"	Larghezza per vano 1592 Compartment width 1592 777 + 777 30 1/2" + 30 1/2"	Larghezza Width 1202 - 1592 47 3/4" - 62 3/4"	Scrittoio Desk Larghezza Width 1100 - 1490 43 3/4" - 58 3/4"
Profondità Depth 588 (anta 25) 593 (anta 27-28-30) 604 (anta 38)	Profondità Depth 586 23"	Altezza Height 2319 - 2415 - 2575 - 2831 91 3/4" - 95" - 101 1/2" - 111 1/2"	Profondità per fianco di finitura Depth for finishing side panel 613 (anta 25) 618 (anta 27-28-30) 629 (anta 38)	Altezza Height 155 6"
23 1/4" (door 1") 23 1/4" (door 1" - 1" - 1 3/4") 23 3/4" (1 1/2")			24 1/4" (door 1") 24 1/4" (door 1" - 1" - 1 3/4") 24 3/4" (door 1 1/2")	Profondità Depth 476 18 3/4"

Accessori — Accessories

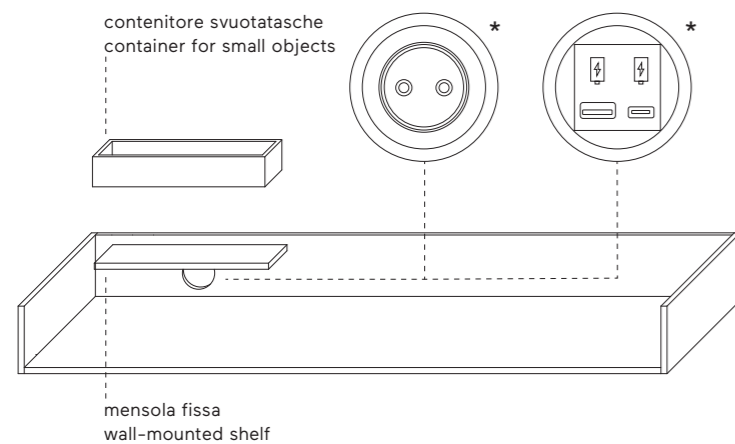

01

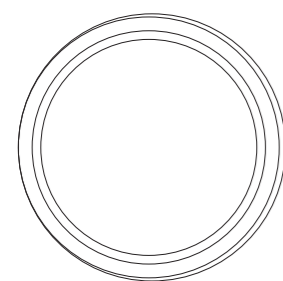

03

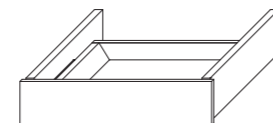

02



<p>01</p> <p>Scrittoio* Desk*</p> <p>Larghezza Inglese 1100 - 1490 43¾" - 58¾"</p> <p>Altezza Height 155 6"</p> <p>Profondità Depth 476 18¾"</p> <p>Finitura Internal Laccato opaco LCT Rovere termotrattato Noce-L</p> <p>Matt lacquered LCT Heat-treated oak Walnut-L</p>	<p>Mensola fissa Wall-mounted shelf</p> <p>Dimensioni (L x P) Dimensions (W x D) 400 x 120 15¾" x 4¾"</p> <p>Spessore Thickness 15 ½"</p> <p>Finitura Internal Laccato opaco LCT Rovere termotrattato Noce-L</p> <p>Matt lacquered LCT Heat-treated oak Walnut-L</p>	<p>Contenitore svuotatasche Container for small objects</p> <p>Dimensioni (L x P x H) Dimensions (W x D x H) 395 x 115 x 70 15½" x 4½" x 2¾"</p> <p>Spessore Thickness 10 ½"</p> <p>Finitura Internal Rovere termotrattato Noce-L</p> <p>Rovere termotrattato Noce-L</p>	<p>02</p> <p>Cassetto (opzionale) Drawer (optional) Posizionabile a sinistra o a destra dello scrittoio</p> <p>Positionable on the left or right of the desk</p> <p>Dimensioni (L x P x H) Dimensions (W x D x H) 400 x 355 x 100 15¾" x 14" x 4"</p> <p>Finitura esterna External finishing Laccato opaco LCT Rovere termotrattato Noce-L</p> <p>Matt lacquered LCT Heat-treated oak L-walnut</p>	<p>Finitura interna Internal finishing Laccato opaco LCT Fumo 906</p> <p>Matt lacquered LCT Fumo 906</p>	<p>*</p> <p>Scrittoio dotato di foro passacavi posizionato sotto mensola fissa. Sono disponibili per l'alloggio: una presa Shuko o una presa con doppia connessione USB</p> <p>Desk equipped with cables outlet hole positioned under the wall-mounted shelf. A Shuko socket or a socket with double USB connection are available</p>
---	--	--	--	---	---

<p>03</p> <p>Smart mirror (opzionale) Smart mirror (optional) Libera posizione. Dotato di due tipologie di luci azionabili separatamente da un telecomando multifunzione:</p> <ul style="list-style-type: none"> - luce perimetrale calda 3000K dimmerabile - luce frontale naturale 4200K dimmerabile <p>Can be positioned anywhere. Fitted with two types of lights that can be opera- ted using a multifunctio- nal remote control:</p> <ul style="list-style-type: none"> - perimetral light warm 3000 K dimmable - perimetral light warm 4200 K dimmable 	<p>Dimensione Dimension Ø 600 Ø 23½"</p>
---	---

Contenitori pensili — Wall-mounted containers

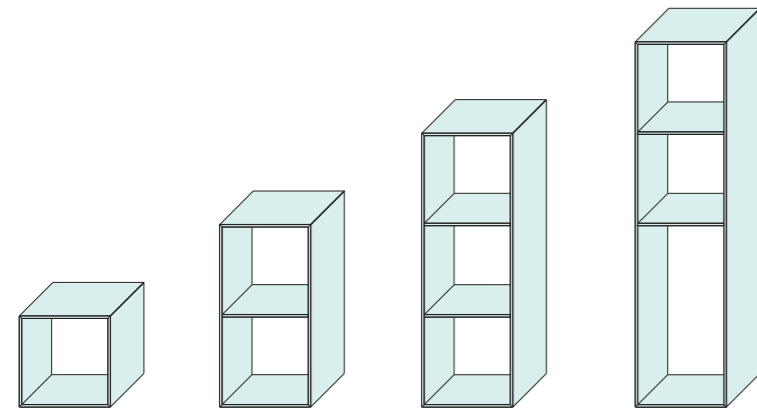

05

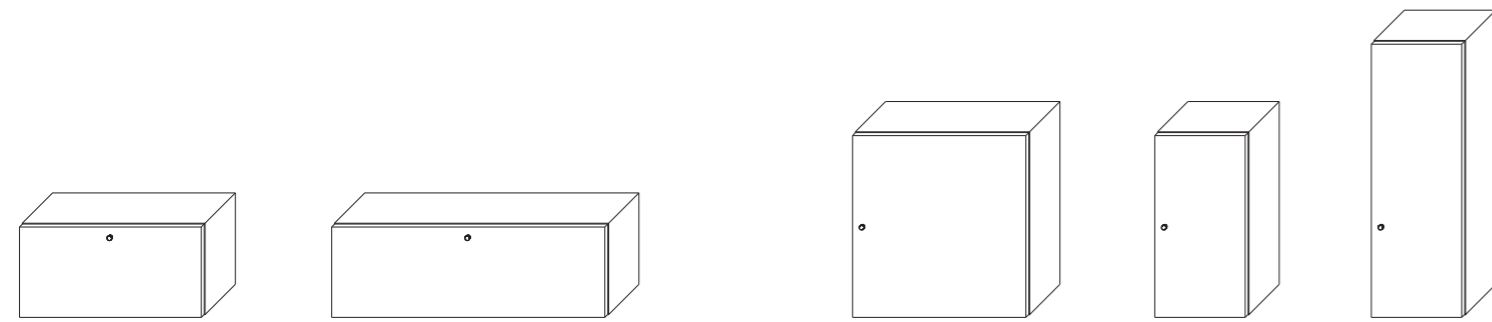

06

07

<p>05</p> <p>Box a giorno in vetro Glass open box container Predisposti per fissaggio su pannello boiserie</p> <p>Prepared for fixing on boiserie panels</p> <p>Dimensioni (L x H) Dimensions (W x H) 270 x 270 270 x 540* 270 x 810* 270 x 1080*</p> <p>10 3/4" x 10 3/4" 10 3/4" x 21 1/4"* 10 3/4" x 32"* 10 3/4" x 42 1/2"*</p>	<p>06</p> <p>Contenitore LTFRAME orizzontale Horizontal LTFRAME container Predisposto per fissaggio su pannello boiserie. Pensile comprensivo di top e fianchi. Anta a ribalta, apertura tramite maniglia o push-pull</p> <p>Can be installed on boiserie panelling. Wall-mounted, inclusive of top and sides. Flap door, opening via handle or push-pull mechanism</p> <p>Dimensioni (L x H) Dimensions (W x H) 540 x 270 810 x 270</p> <p>21 1/4" x 10 3/4" 32" x 10 3/4"</p> <p>Profondità Depth 280 11"</p>	<p>07</p> <p>Contenitore LT FRAME verticale Vertical LT FRAME container Predisposto per fissaggio su pannello boiserie. Pensile comprensivo di top, fianchi e un ripiano in legno spostabile. Anta battente, apertura tramite maniglia o push-pull</p> <p>Can be installed on boiserie panelling. Wall-mounted, inclusive of top, sides and a movable wooden shelf. Hinged door, opening via handle or push-pull mechanism</p> <p>Dimensioni (L x H) Dimensions (W x H) 270 x 540 270 x 810 515 x 540</p> <p>10 3/4" x 21 1/4" 10 3/4" x 32" 20 1/4" x 21 1/4"</p> <p>Profondità Depth 280 11"</p>	<p>*</p> <p>Possibilità di fissaggio in verticale o in orizzontale</p> <p>Option to install vertically or horizontally</p>
--	--	---	--

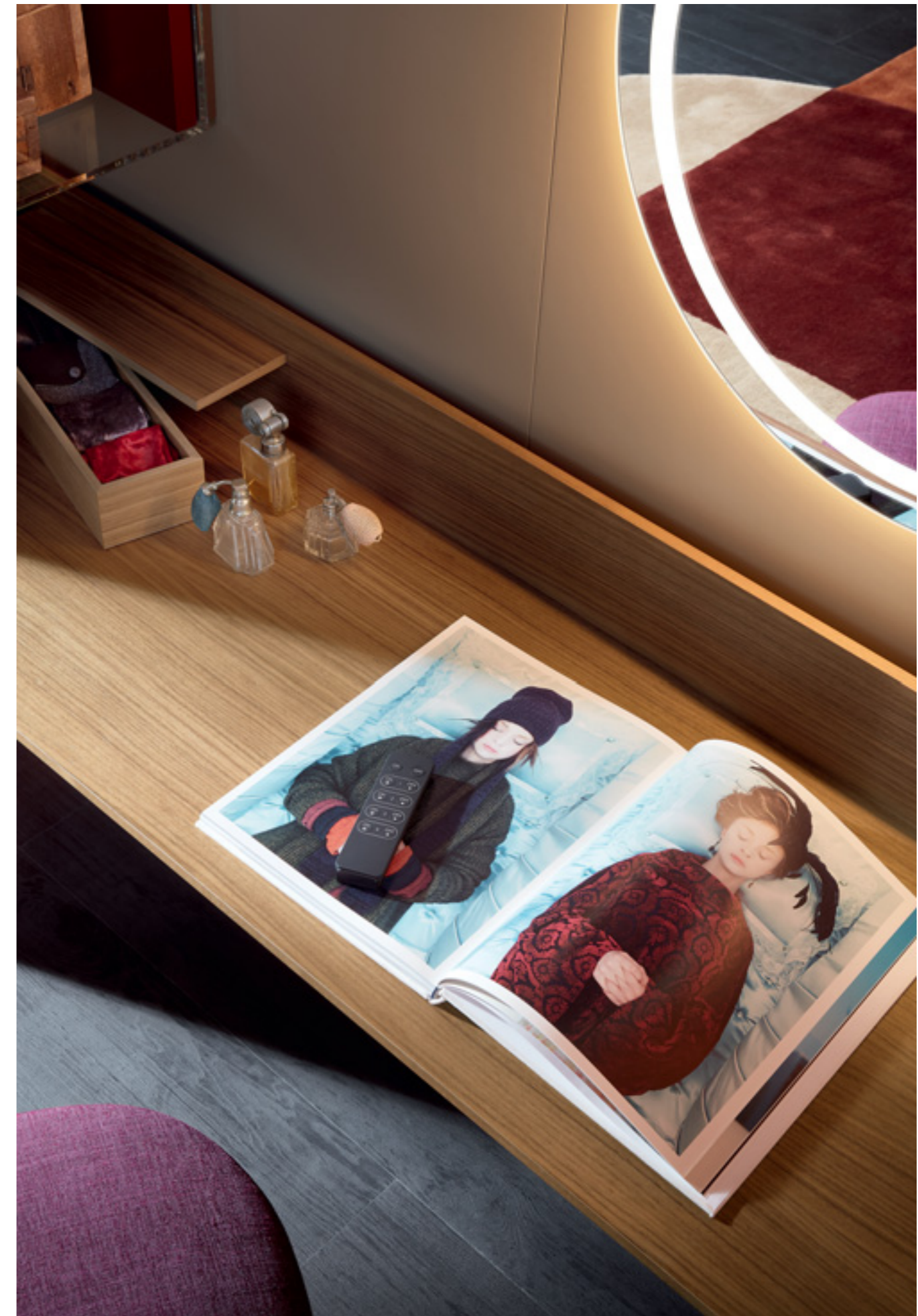

Vano lavatrice — Washing machine compartment

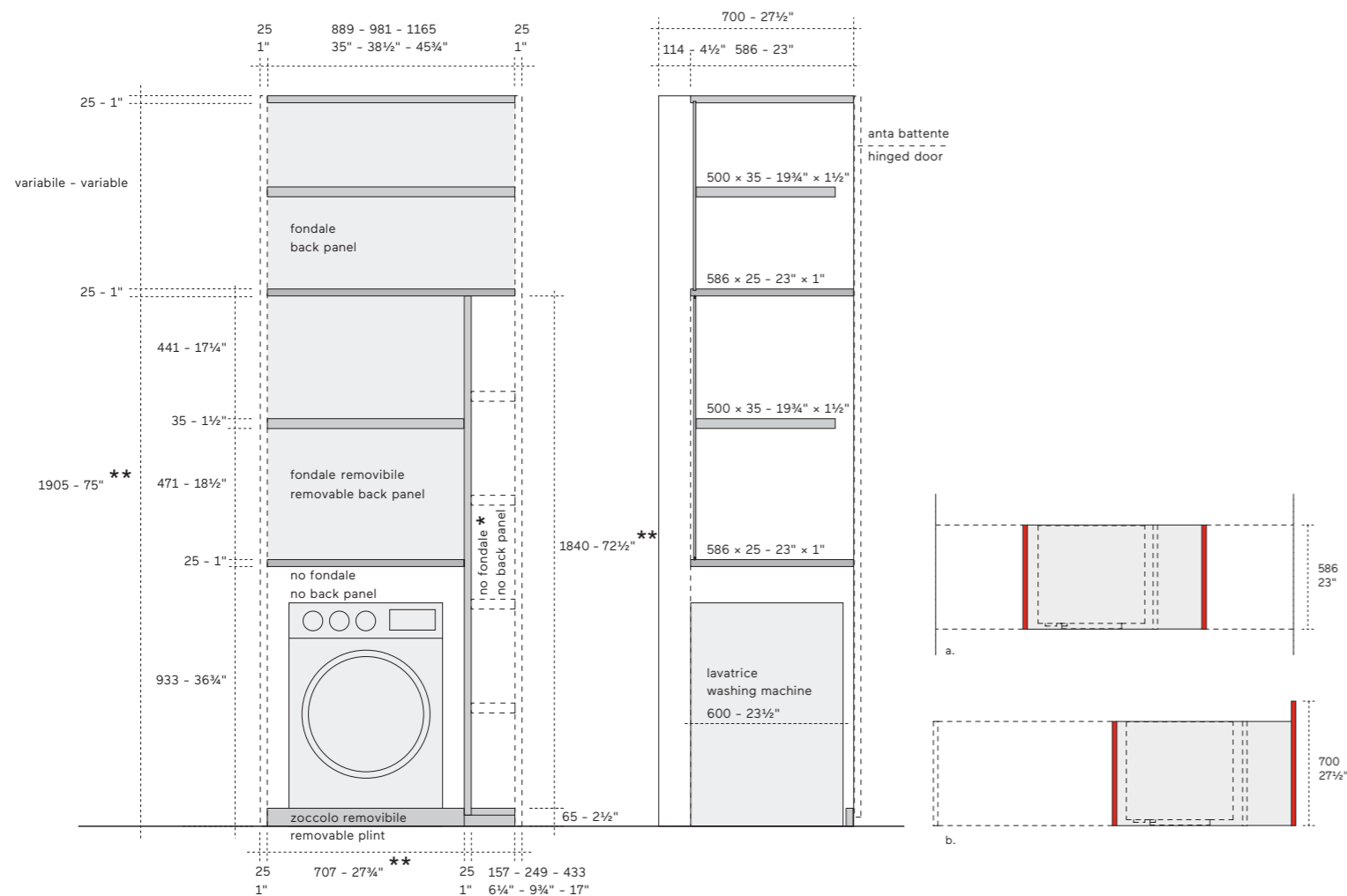

01

01

Colonna per vano lavatrice Column for washing machine	Profondità colonna Column depth
	586 23"
Larghezza Width	Profondità fianco interno Internal side depth
889 - 981 - 1165 35" - 38½" - 45¾"	586 23"
Altezza Height	Profondità fianco esterno External side panel depth
2048 - 2368 - 2464 - 2624 - 2880 80¾" - 93¾" - 97" - 103¾" - 113½"	586 - 700 23" - 27½"
	Finitura colonna Column finishing
	melaminico 6 varianti melamine 6 type

Esempio posizione vano tecnico
Example of positioning of technical compartment
a. vano tecnico interno
b. vano tecnico esterno

a. internal technical compartment
b. external technical compartment

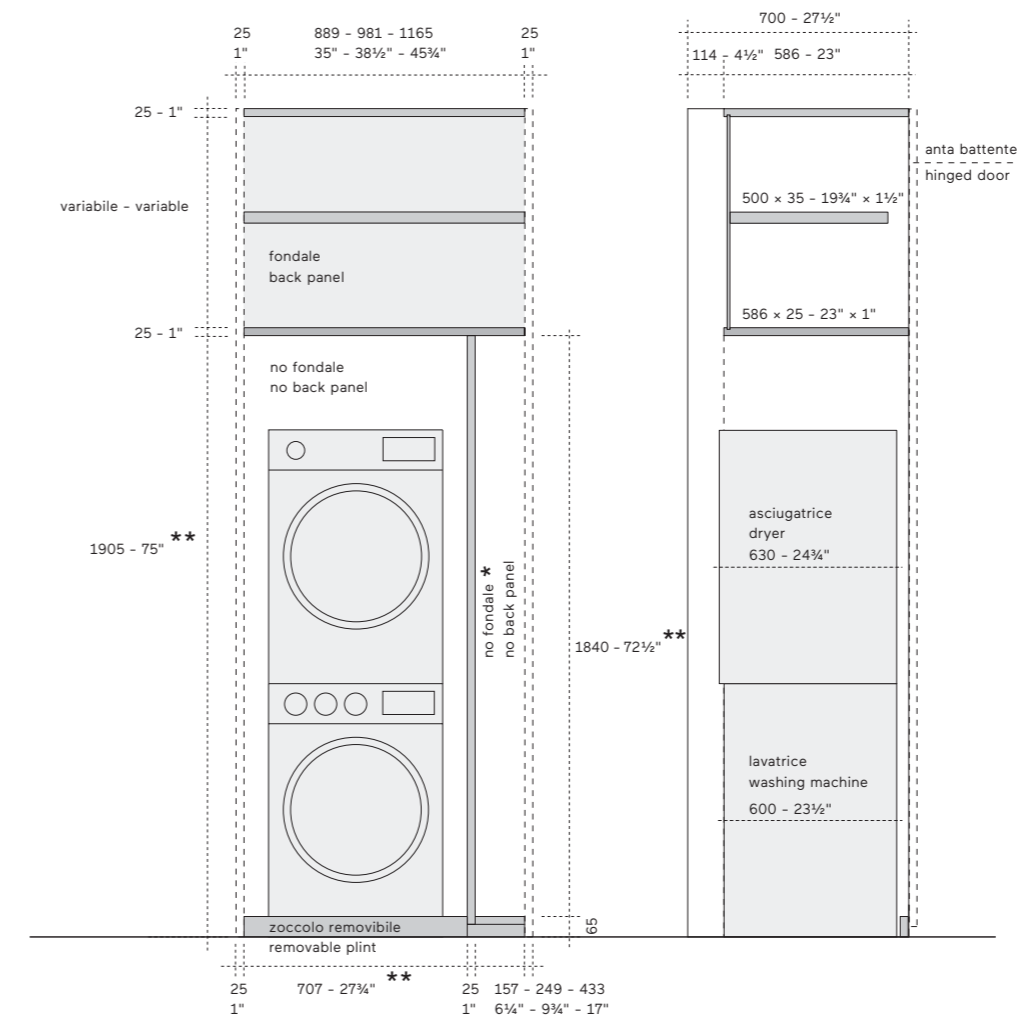

02

02

Colonna per vano lavatrice e asciugatrice Column for washing machine and dryer	Profondità colonna Column depth
	586 23"
Larghezza Width	Profondità fianco interno Internal side depth
889 - 981 - 1165 35" - 38½" - 45¾"	586 23"
Altezza Height	Profondità fianco esterno External side panel depth
2048 - 2368 - 2464 - 2624 - 2880 80¾" - 93¾" - 97" - 103¾" - 113½"	586 - 700 23" - 27½"
	Finitura colonna Column finishing
	melaminico 6 varianti melamine 6 type

* Vano disponibile con o senza ripiani (nr.4)
Compartment available with or without the shelves (nr.4)

** Dimensioni fisse
Fixed dimensions

Armadio sovrapposto — Overlapping wardrobe

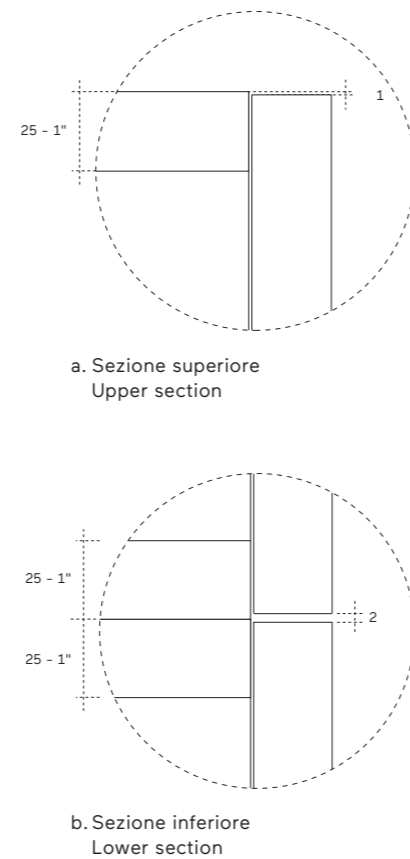
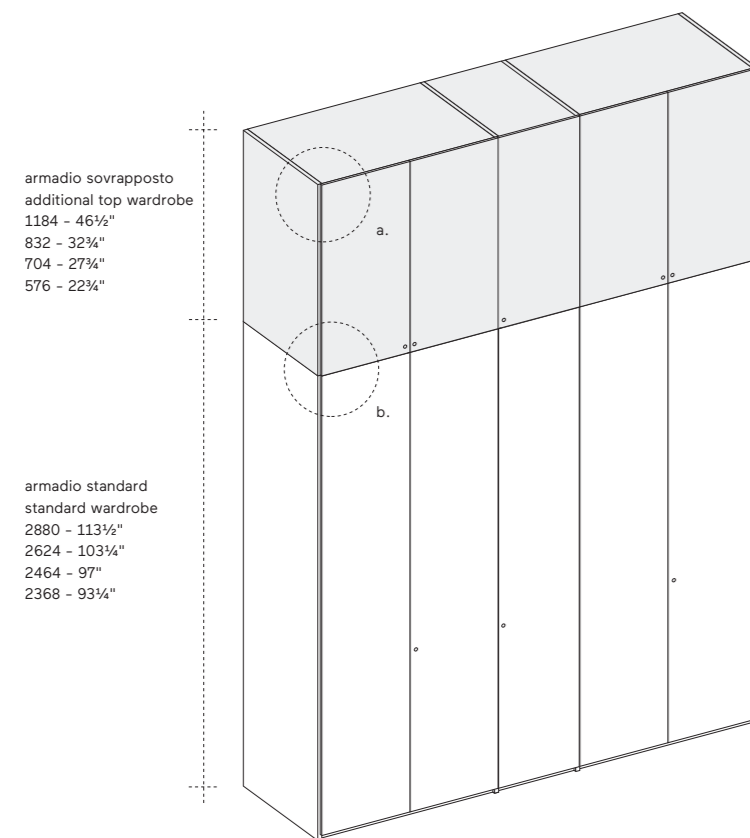

Armadio sovrapposto Overlapping wardrobe

**Altezza
Height**
576 - 704 - 832 - 1184
22 3/4" - 27 3/4" - 32 3/4" -
46 1/2"

**Profondità
Depth**
586
23"

**Ante disponibili
Available doors**
Prima
Text

**Maniglia
Handle**
Pag. da 118 a 127
Escluse MA53 - MA81

Pages 118 to 127
Not including MA53 -
MA81

**Possibili altezze
raggiungibili
Height reachable**
MIN. 2944 - 116"
MAX. 4064 - 160"

**Fianchi sovrapposti
disponibili
Overlapping external
side panels available**
Fianco esterno standard
Fianco di finitura
profondità 613
Profilo di finitura
profondità 26

External standard side
panel
Finishing side panel
depth 24 3/4"
Finishing profile depth 1"

Passaggio porta, ponte armato Passage and bridge solution

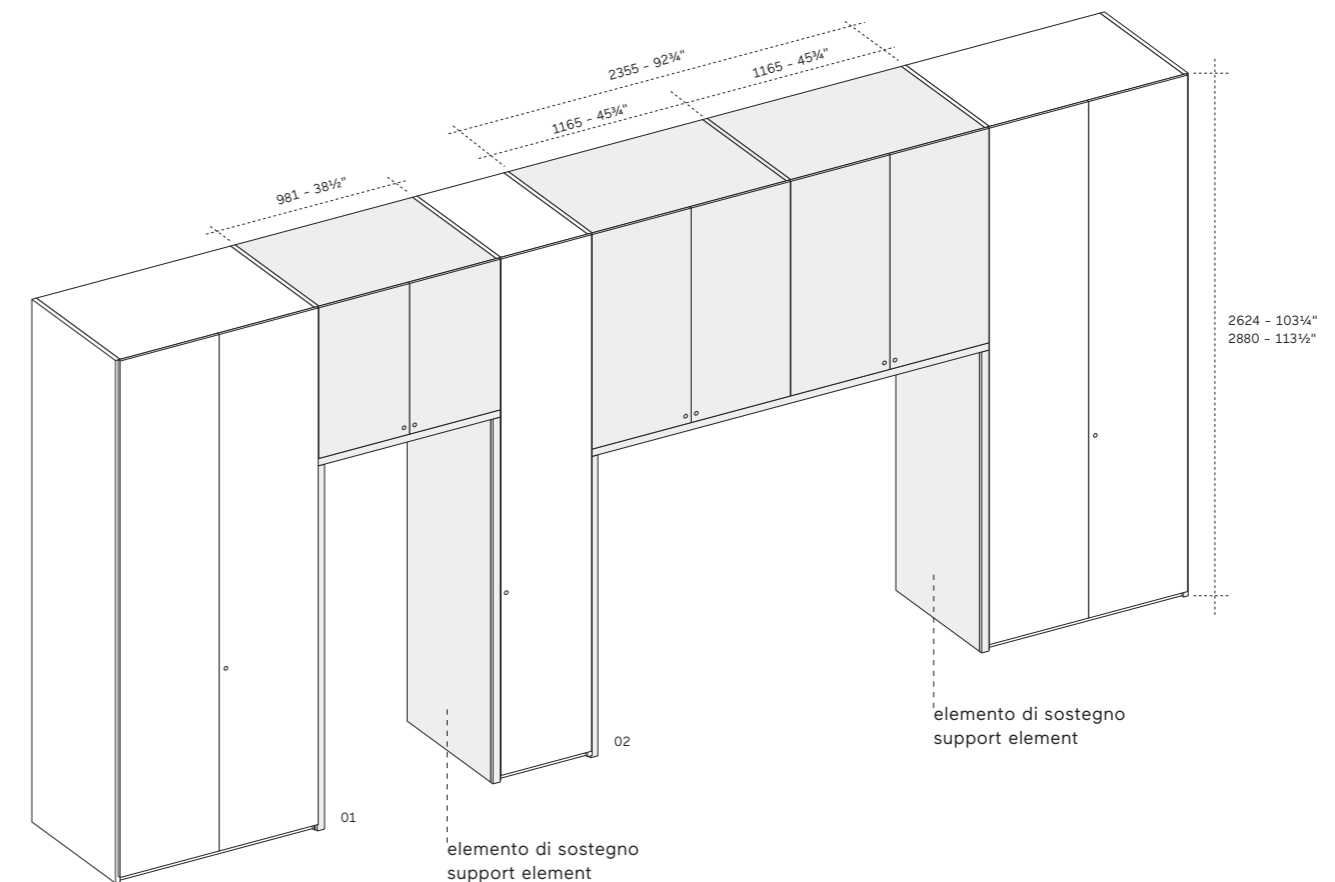

01

**Colonna passaggio porta
Column passage solution**

**Larghezza
Width**
981
38 1/2"

**Altezza
Height**
2624 - 2880
103 3/4" - 113 1/2"

**Larghezza utile
Usable width**
917
36"

**Altezza utile
Usable height**
2005 - 2260
79" - 89"

**Dimensioni colonna sopra
porta
Column dimensions
above door**

**Larghezza
Width**
981
38 1/2"

**Altezza
Height**
574 - 830
22 1/2" - 32 3/4"

**Anta
Door**
Prima

**Maniglia
Handle**
Pag. da 118 a 127
Escluse MA53 - MA81

Pages 118 to 127
Not including MA53 -
MA81

02

**Soluzione ponte
Bridge solution**

**Larghezza
Column width**
2355
92 3/4"

**Altezza
Height**
2624 - 2880
103 3/4" - 113 1/2"

**Larghezza utile
Usable width**
2291
90 3/4"

**Altezza utile
Usable height**
1653
65"

**Dimensioni colonna
sopra ponte
Column dimensions
above bridge**

**Larghezza
Width**
1165 (x 2)
45 3/4" (x 2)

**Altezza
Height**
926 - 1182
22 1/2" - 32 3/4"

**Anta
Door**
Prima

**Maniglia
Handle**
Pag. da 118 a 127
Escluse MA53 - MA81

Pages 118 to 127
Not including MA53 -
MA81

**Finitura
Finishing**

**Anta
Door**
Laccato opaco LCT
Laccato lucido LCL
Rovere carbone
Rovere termotrattato
Noce-L
Melaminico 7 varianti

Matt lacquered LCT
Glossy lacquered LCL
Carbone oak
Heat-treated oak
L-walnut
Melamine 7 types

**Elemento di sostegno
Support element**
Laccato opaco LCT
Matt lacquered LCT

Porta — Door

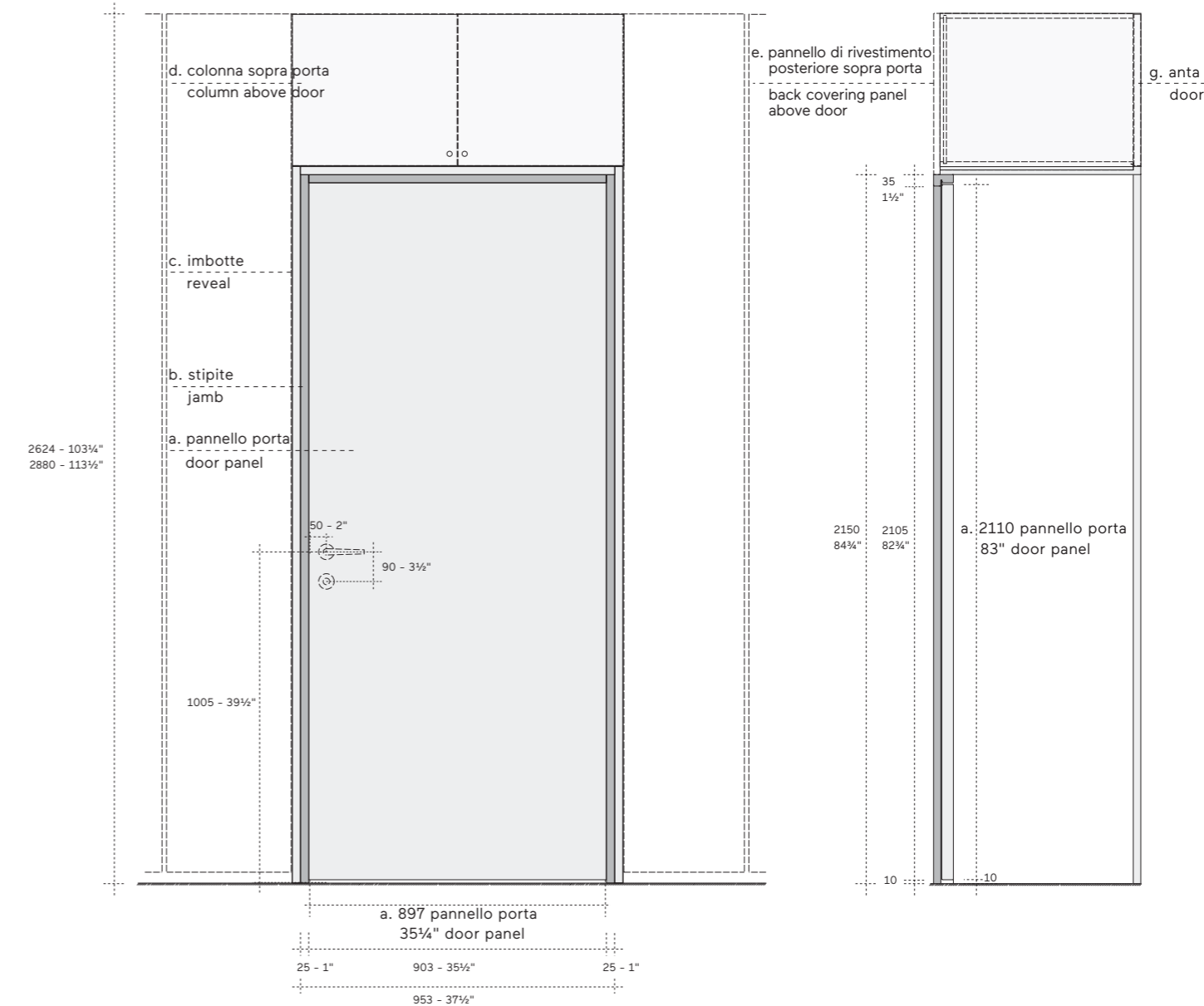
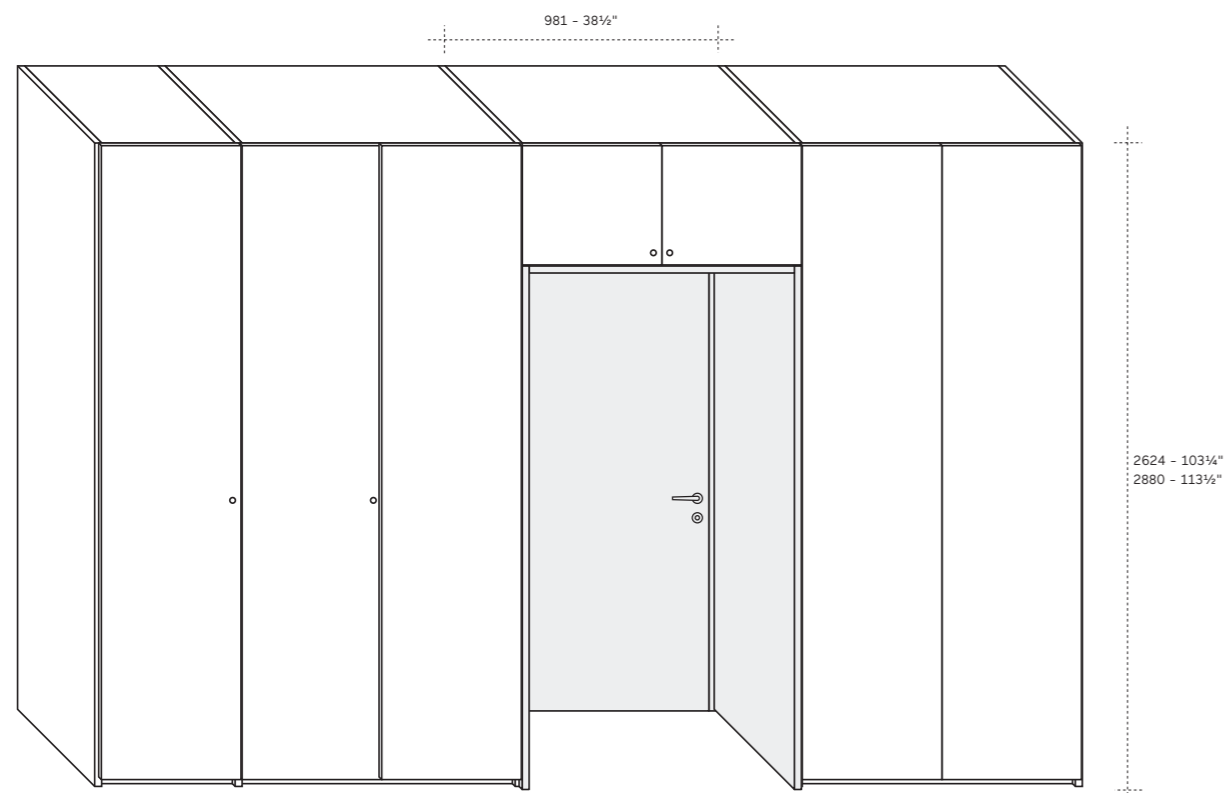

Dimensioni colonna Column dimensions	Dimensioni pannello porta Door panel dimensions	Apertura Opening	Dimensioni colonna sopra porta Column above door dimensions
Larghezza Width 981 38½"	Larghezza Width 897 35¼"	- apertura verso SX, a tirare - apertura verso DX, a tirare - apertura verso SX, a spingere - apertura verso DX, a spingere	Larghezza Width 981 38½"
Altezza Height 2624 - 2880 103¼" - 113½"	Altezza Height 2110 83"	- left opening, to pull - right opening, to pull - left opening, to push - right opening, to push	Altezza Height 446 - 702 17½" - 27¾"
Larghezza vano porta Space door width 953 37½"	Spessore Depth 35 1½"		Anta Door Prima
Altezza vano porta Space door height 2150 84¼"	Maniglia Handle Non inclusa Not included		Maniglia Handle Pag. da 118 a 127 Escluse MA53 - MA81 Pages 118 to 127 Not including MA53 - MA81

**Nota
Note**
Il pannello porta è dotato di cerniere e serratura patent completa di chiave. Specificare il senso di apertura (dx o sx)

Door panel equipped with hinges and patent lock with key. Please indicate the opening direction (left or right)

Componenti vano porta Column door componet	Finiture Finishing	Colonna sopra porta Column above door	Pannello di rivestimento posteriore opzionale (spessore 19) Optional back covering panel above door (thickness ¼")
a. Pannello porta b. Stipite c. Imbotte d. Colonna sopra porta e. Pannello di rivestimento posteriore sopra porta f. Pannello di rivestimento posteriore g. Anta	Pannello porta e stipite Door panel and jamb Laccato opaco LCT Matt lacquered LCT	Struttura Structure Melaminico 6 varianti Melamine 6 type	Laccato opaco LCT Matt lacquered LCT
a. Door panel b. Jamb c. Reveal d. Column above door e. Back covering panel above door f. Back covering panel g. Doors	Imbotte Reveal Melaminico Laccato opaco LCT Laccato lucido LCL Rovere carbone Rovere termotrattato Noce-L Melamine Matt lacquered LCT Glossy lacquered LCL Carbone oak Heat-trated oak L-walnut	Anta Door Prima Finiture anta Door finishing Melaminico Laccato opaco LCT Laccato lucido LCL Rovere carbone Rovere termotrattato Noce-L Melamine Matt lacquered LCT Glossy lacquered LCL Carbone oak Heat-trated oak L-walnut	

Colonna con cassettera esterna, elemento a giorno

Column with external drawers, open element

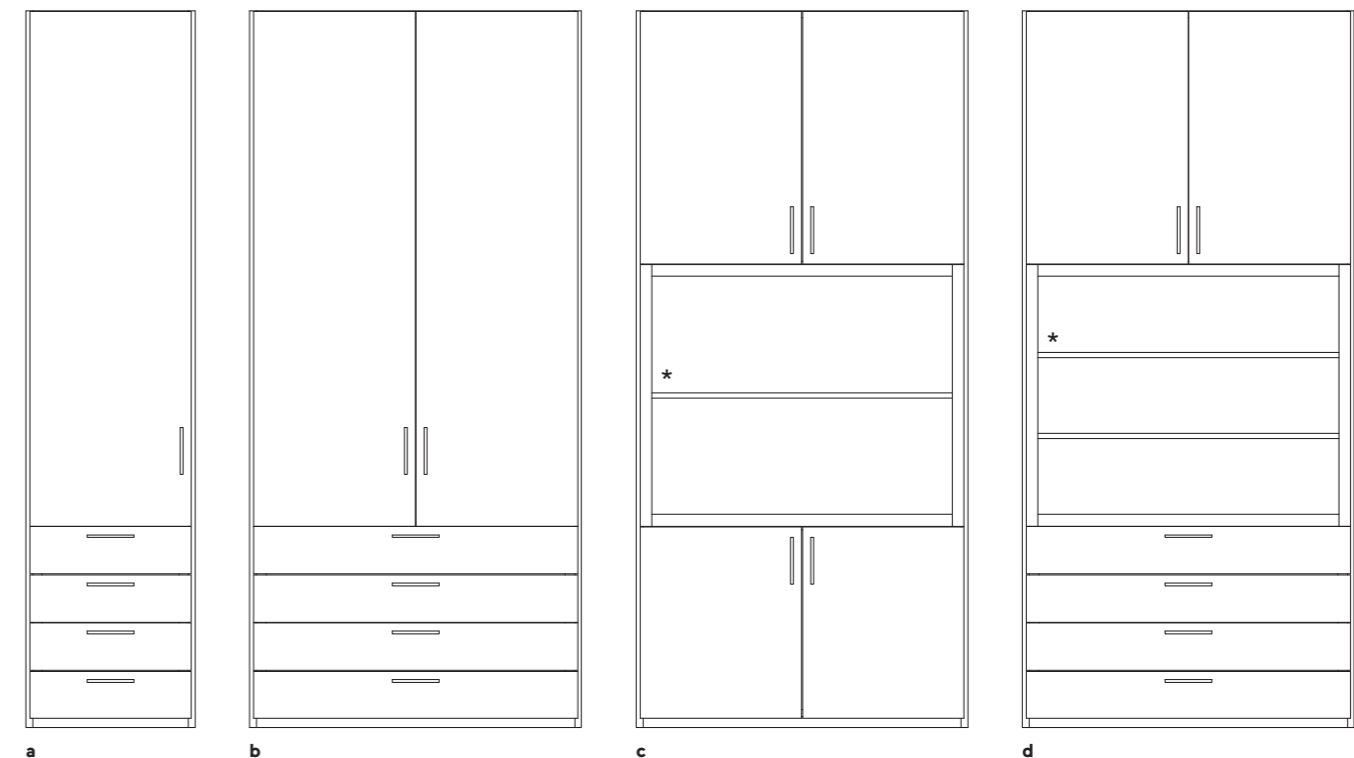
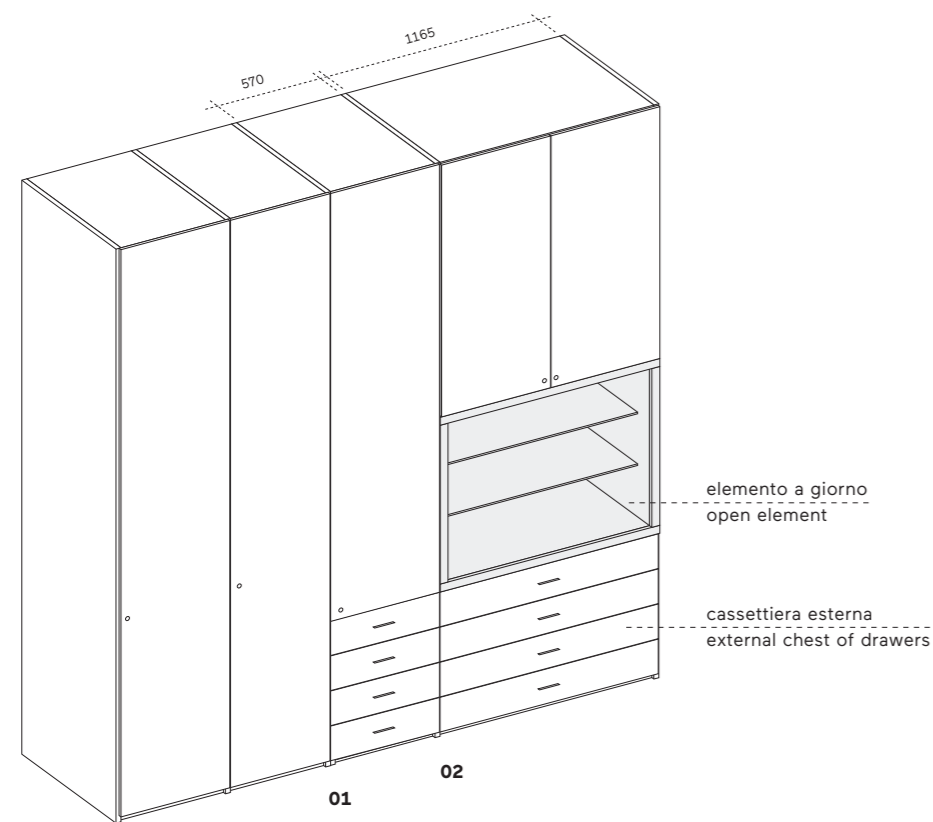

01

Colonna per cassettera esterna
Column for external chest of drawers

Larghezza
Width
570 - 1165
22½" - 45¾"

Altezza
Height
2368 - 2464 - 2880
80¾" - 93¾" - 97" - 113½"

Anta superiore
Upper door
Prima

Maniglia
Handle
Pag. da 118 a 127
Pages 118 to 127

Finitura anta
Door finishing
Laccato opaco LCT
Matt lacquered LCT

Cassettera esterna frontale legno
External chest of drawers wood drawer front

Larghezza
Width
570 - 1165
22½" - 45¾"

Altezza
Height
750
29½"

Maniglia
Handle
MA01 - MA02 - MA03 - MA12

Finitura
Finishing
Laccato opaco LCT
Matt lacquered LCT

02

Colonna con elemento a giorno
Column with open element

Larghezza
Width
1165
45¾"

Altezza
Height
2368 - 2464 - 2624 - 2880
93¾" - 97" - 103¾" - 113½"

Anta superiore
Upper door
Prima

Maniglia
Handle
Pag. da 118 a 127
Pages 118 to 127

Finitura anta
Door finishing
Laccato opaco LCT
Matt lacquered LCT

Elemento a giorno
Open element

Larghezza
Width
1187
46¾"

Altezza
Height
958
37¾"

Finitura
Finishing
Laccato opaco LCT
Matt lacquered LCT

Attrezzatura disponibile
Available accessories
Ripiano in legno laccato opaco LCT
Matt lacquered LCT
wooden shelf

Layout colonne disponibili

Available layout columns

a.
Colonna 570
Column 22½"
Cassettera H 750 con 4 cassetti.
Anta battente singola

Chest of drawers H 29½" with 4 drawers.
Single hinged door

b.
Colonna 1165
Column 45¾"
Cassettera H 750 con 4 cassetti.
Doppia anta battente superiore

Chest of drawers H 29½" with 4 drawers.
Double upper hinged door

c.
Colonna 1165
Column 45¾"
Doppia anta battente superiore.
Doppia anta battente inferiore.
Elemento a giorno con 1 ripiano

Double upper hinged doors.
Double lower hinged doors.
Open element with 1 wood shelf

d.
Colonna 1165
Column 45¾"
Cassettera H 750 con 4 cassetti.
Doppia anta battente superiore.
Elemento a giorno con 2 ripiani

Chest of drawers H 29½" with 4 drawers.
Double upper hinged doors.
Open element with 2 wood shelf

*
Ripiani opzionali
Option shelf

Finiture struttura — Structure finishings

Le essenze legnose, le argille, sono materiali che Lema utilizza per le ante, fianchi esterni e zoccoli degli armadi e che tratta con la sapiente cura della più antica tradizione. Le finiture interne in melaminico nelle varianti in lino, visone, larice moka, larice sbiancato, larice grigio e canvas costituiscono l'ampia gamma di offerta per personalizzare l'armadio Lema. Gli interni dei cassetti sono proposti nella finitura stone, grigio antracite opaco dal vellutato effetto tessile, adattabile a qualsiasi melaminico proposto. Le parti metalliche sono suggerite in metallo bronzo per l'abbinamento con interni in larice moka, visone e larice grigio e in metallo sand per canvas, lino e larice sbiancato.

Woods and clays are materials which whom Lema produces wardrobes doors, external side panels and plinths.

These latter are treated with the care of our longstanding handicraft works.

Inner melamine finishings in lino, visone, moka, bleached and grey larch, canvas make up a great offer in order to customize Lema wardrobes.

The inside part of drawers are designed in stone, a matt anthracite grey with soft velvet textile effect adaptable to every melamine in collection.

Metal details are suggested to be in bronze with moka larch, visone and grey larch while sand properly matches canvas, lino and bleached larch.

Melaminici Melamines



Canvas



Lino



Larice sbiancato
Bleached larch



Larice grigio
Grey larch

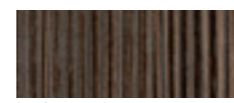

Larice moka
Moka larch



Visone



Abbinamenti melaminico/metallo



01

02

03

01

Finiture struttura
Structure finishings
Melaminico canvas
Melamine canvas

Abbinamento metallo
consigliato
Recommended matching
metal
Metallo verniciato sand
epox M455

Metal sand epox painted
M455

02

Finiture struttura
Structure finishings
Melaminico larice
sbiancato

Melamine bleached larch
Abbinamento metallo
consigliato
Recommended matching
metal
Metallo verniciato sand
epox M455

Metal sand epox painted
M455
Metal sand epox painted
M455

03

Finiture struttura
Structure finishings
Melaminico lino
Melamine lino

Abbinamento metallo
consigliato
Recommended matching
metal
Metallo verniciato sand
epox M455

Metal sand epox painted
M455

Melamine/metal match



04

05

06

04

Finiture struttura
Structure finishings
Melaminico larice grigio,
venatura orizzontale

Melamine larch grey,
horizontal veining
Abbinamento metallo
consigliato
Recommended matching
metal
Metallo verniciato bronzo
epox M421

Metal bronze epox
painted M421
Metal bronze epox
painted M421

05

Finiture struttura
Structure finishings
Melaminico larice moka
Melamine larch moka

Abbinamento metallo
consigliato
Recommended matching
metal
Metallo verniciato bronzo
epox M421

Metal bronze epox
painted M421

06

Finiture struttura
Structure finishings
Melaminico visone
Melamine visone

Abbinamento metallo
consigliato
Recommended matching
metal
Metallo verniciato bronzo
epox M421

Metal bronze epox
painted M421

2.

DOORS

Armadio al Centimetro offre la possibilità di costruire uno spazio domestico riservato e personale. Per questo nasce come progetto incentrato sulla massima flessibilità: di dimensioni prima di tutto, ma anche di modelli, materiali, elementi, finiture, accessori, attrezzature. Una varietà di componenti che dedicano a ognuno la massima scelta, secondo le singole necessità e i gusti. Il sistema si sviluppa intorno ai moduli base formati da strutture e ante: battenti, scorrevoli e complanari.

Armadio al Centimetro offers the possibility of creating a private and very personal domestic space. For this reason the project focused from the very start on creating maximum flexibility, principally as regards the dimensions but also in terms of models, materials, elements, finishings and accessories. A wide variety of components gives everyone the maximum choice, enabling people to select according to their own needs and tastes. The system develops around the base modules formed of structures and doors: hinged, sliding and coplanar.

Ante battenti — Hinged doors

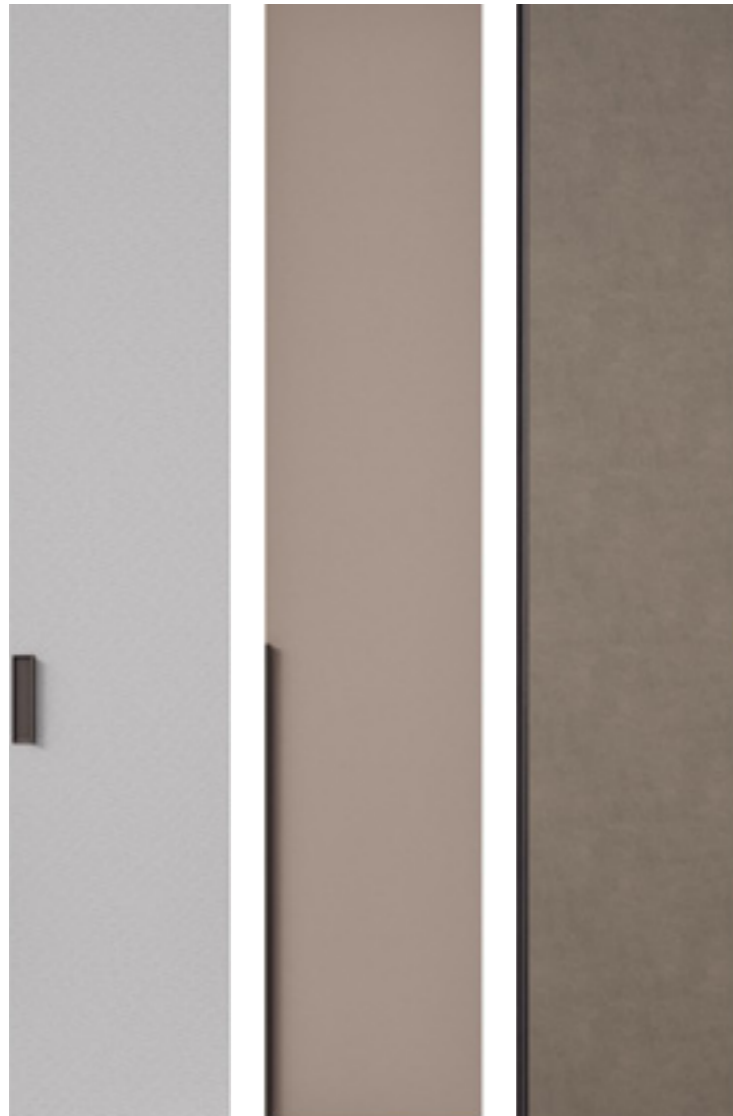

Prima
p. 92

Flago
p. 94

Text
p. 96

Abaco — Abacus



Next
p. 98

Elegant
p. 100

Kyn
p. 102

Ellevi
p. 104

Ante battenti — Hinged doors



Naica
p. 106

Nur
p. 108

Emery
p. 110

Abaco — Abacus



Dandy
p. 112

Warm
p. 114

Seryasse
p. 116

Ante battenti — Hinged doors

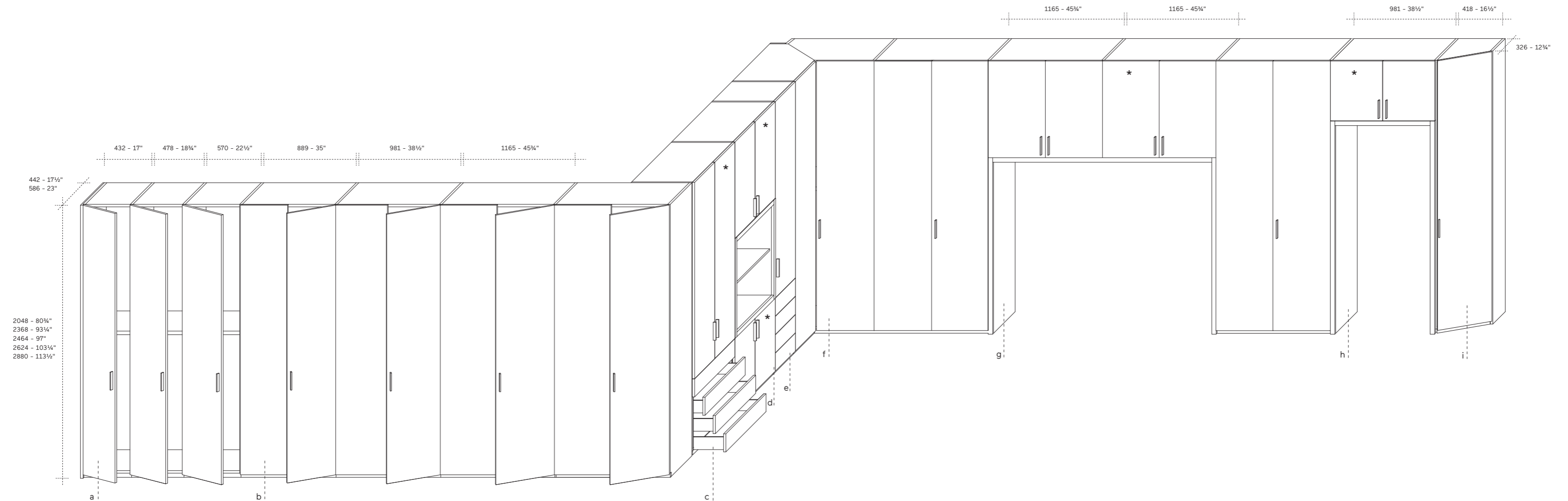

Armadio ante battenti Wardrobe with hinged doors

- a. colonne singole
- b. colonne doppie
- c. colonna doppia con cassetteria esterna
- d. colonna doppia con elemento a giorno
- e. colonna singola con cassetteria esterna
- f. colonna angolare
- g. soluzione a ponte
- h. passaggio porta
- i. colonna terminale

- a. single columns
- b. double columns
- c. double column with external chest of drawers
- d. double column with open section
- e. single column with external chest of drawers
- f. corner column
- g. bridged solutions
- h. overdoor units
- i. end column

Dimensioni Dimensions

6 larghezze 6 widths

432 - 478 - 570 - 889 - 981 - 1165
17" - 18¾" - 22½" - 35" - 38½" - 45¾"

5 altezze 5 heights

2048 - 2368 - 2464 - 2624 - 2880
80¾" - 93¾" - 97" - 103¾" - 113½"

2 profondità 2 depth

Fianco 442 - 586
Side panel 17½" - 23"

*
Soluzione disponibile solo con ante battente Prima

Solution available only with Prima hinged door

Componibilità — Layouts

1396 - 55"	889 - 35"	432 17"	
1442 - 56½"	889 - 35"	478 18½"	
1488 - 58½"	981 - 38½"	432 17"	
1534 - 60½"	981 - 38½"	478 18½"	
1626 - 64"	981 - 38½"	570 22½"	
1672 - 65½"	1165 - 45½"	432 17"	
1718 - 67½"	1165 - 45½"	478 18½"	
1810 - 71½"	1165 - 45½"	570 22½"	
1853 - 73"	889 - 35"	889 - 35"	
2037 - 80½"	981 - 38½"	981 - 38½"	
2310 - 91"	889 - 35"	889 - 35"	432 17"
2356 - 92½"	889 - 35"	889 - 35"	478 18½"
2405 - 94½"	1165 - 45½"	1165 - 45½"	
2448 - 96½"	889 - 35"	889 - 35"	570 22½"
2494 - 98½"	981 - 38½"	981 - 38½"	432 17"
2540 - 100"	981 - 38½"	981 - 38½"	478 18½"
2632 - 103½"	981 - 38½"	981 - 38½"	570 22½"
2767 - 109"	889 - 35"	889 - 35"	889 - 35"
2859 - 112½"	889 - 35"	981 - 38½"	889 - 35"

2862 - 112½"	1165 - 45½"	1165 - 45½"	432 17"	
2908 - 114½"	1165 - 45½"	1165 - 45½"	478 18½"	
3000 - 118"	1165 - 45½"	1165 - 45½"	570 22½"	
3043 - 119½"	981 - 38½"	981 - 38½"	981 - 38½"	
3224 - 127"	889 - 35"	889 - 35"	889 - 35"	432 17"
3227 - 127"	981 - 38½"	981 - 38½"	981 - 38½"	
3270 - 128½"	889 - 35"	889 - 35"	889 - 35"	478 18½"
3362 - 132½"	889 - 35"	889 - 35"	889 - 35"	570 22½"
3500 - 137½"	981 - 38½"	981 - 38½"	981 - 38½"	432 17"
3546 - 139½"	981 - 38½"	981 - 38½"	981 - 38½"	478 18½"
3595 - 141½"	1165 - 45½"	1165 - 45½"	1165 - 45½"	
3638 - 143½"	981 - 38½"	981 - 38½"	981 - 38½"	570 22½"
3681 - 145"	889 - 35"	889 - 35"	889 - 35"	889 - 35"
4049 - 159½"	981 - 38½"	981 - 38½"	981 - 38½"	981 - 38½"
4052 - 159½"	1165 - 45½"	1165 - 45½"	1165 - 45½"	432 17"
4098 - 161½"	1165 - 45½"	1165 - 45½"	1165 - 45½"	478 18½"
4190 - 165"	1165 - 45½"	1165 - 45½"	1165 - 45½"	570 22½"
4785 - 188½"	1165 - 45½"	1165 - 45½"	1165 - 45½"	1165 - 45½"

Armadio anta battente — Wardrobe with hinged doors

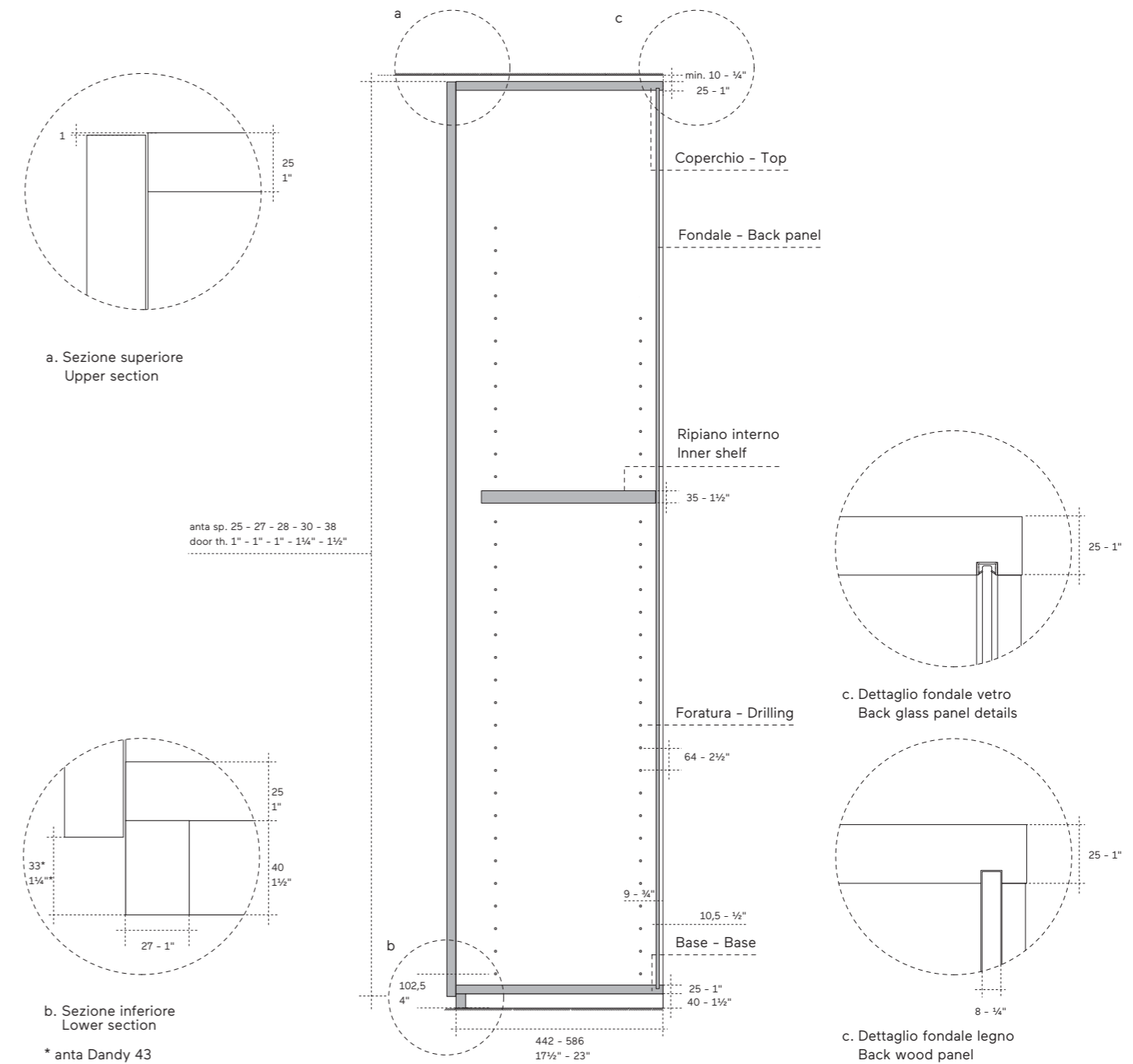

Spazio per montaggio di serie Space for standard installation

In altezza mm. 10 in più dell'altezza del fianco dell'armadio.
In larghezza mm. 50 in più della larghezza dell'armadio.
Su richiesta viene inserita la ferramenta speciale per il montaggio in nicchia

In order to assemble the hinged doors wardrobe, it is necessary to add 2" more than the width of the wardrobe and ¼" more than the height of the side panel.
Special fittings for niche assembly are available on request

Spazio per montaggio in nicchia Space for installation in a recess

In altezza mm. 10 in più dell'altezza del fianco dell'armadio.
In larghezza mm. 15 in più della larghezza dell'armadio

For the niche assembly, it is necessary to add ½" more than the width of the wardrobe and ½" more than the height of the side panel

Spazio per montaggio in presenza di illuminazione Space for installation with led light

In presenza di illuminazione, con o senza contenitore per cablaggi, considerare per il montaggio 50 mm. in più dell'altezza del fianco dell'armadio

If there is lighting, with or without a cable holder, it is necessary 2" more than the height of the side panel of the wardrobe

Nota Note

Per armadio con profondità 442 prevedere fissaggio a parete obbligatorio

The wardrobe with 17½" depth it is necessary to fix on wall

Ante scorrevoli — Sliding doors



Prima
p. 92

Text
p. 96

Ellevi
p. 104

Abaco — Abacus



Naica
p. 106

Emery
p. 110

Warm
p. 114

Ante scorrevoli — Sliding doors

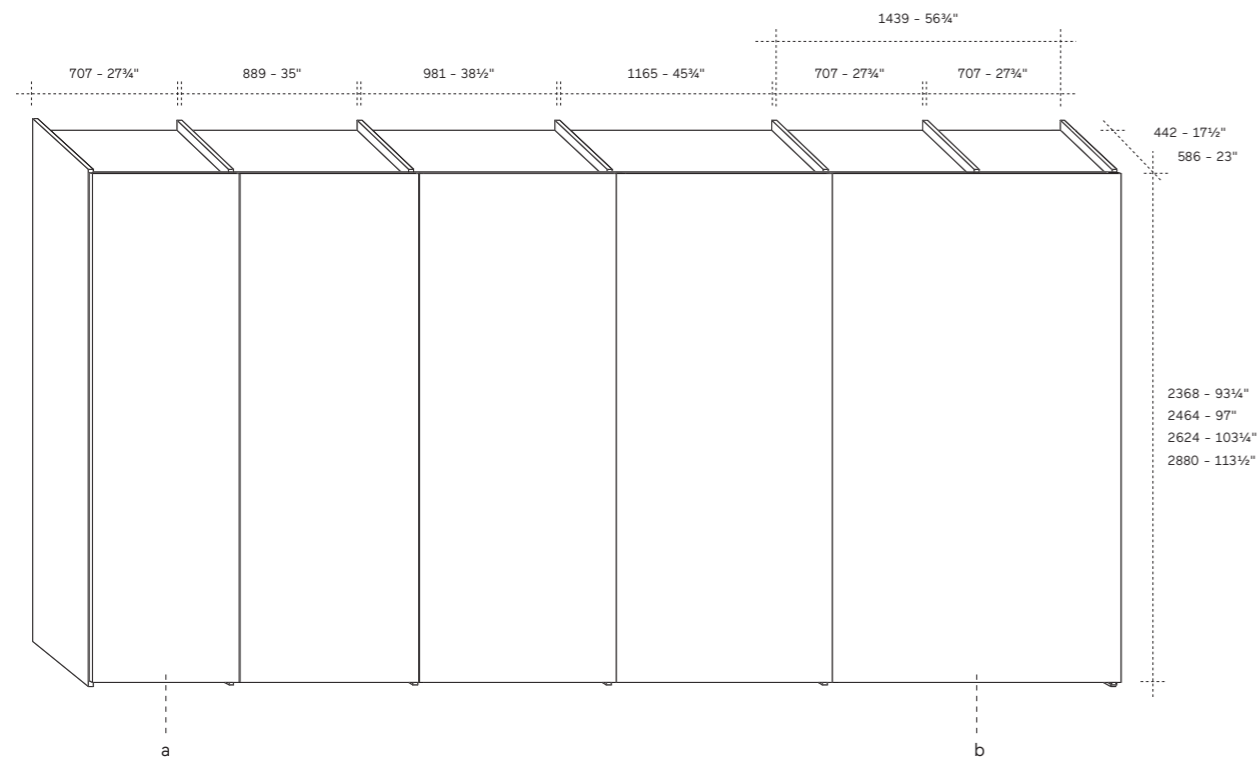

Armadio ante scorrevoli
Sliding door wardrobe

- a. Colonne singole
- b. Colonne doppie

- a. Single columns
- b. Double columns

Dimensioni
Dimensions

5 larghezze
5 widths

- 707 - 889 - 981 - 1165 - 1439
- 27 3/4" - 35" - 38 1/2" - 45 3/4" - 56 3/4"

2 profondità
2 depth

- 442 - 586
- 17 1/2" - 23"

4 altezze
4 heights

- 2368 - 2464 - 2624 - 2880
- 93 3/4" - 97" - 103 3/4" - 113 1/2"

Nota
Note

Il vano 1439 è suddiviso internamente in due vani da 707

The 1439 compartment is divided into two 707 internal compartments

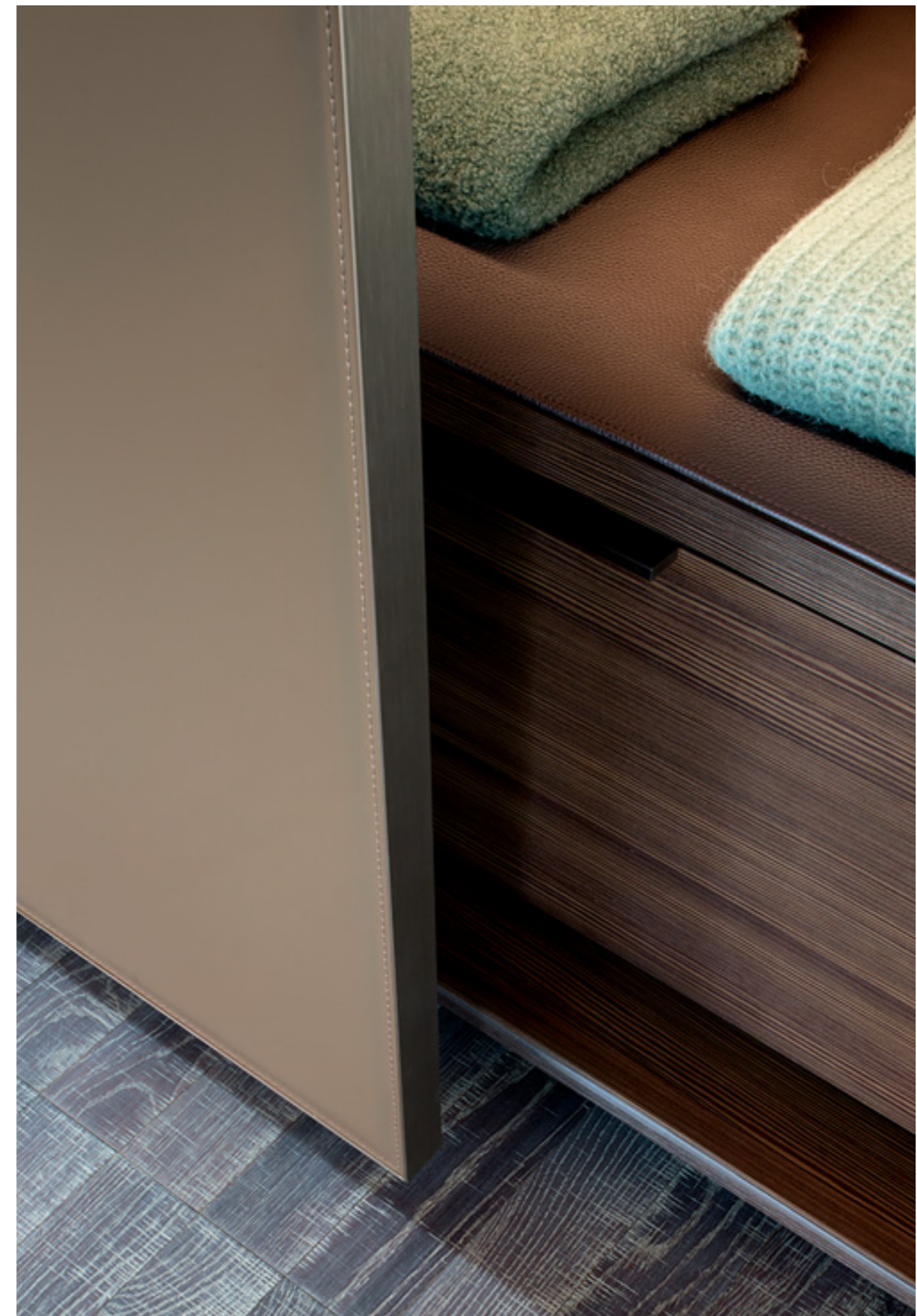

Ante scorrevoli — Sliding doors

Sezione per anta PRIMA - TEXT - EMERY - ELLEVI sp. 25 - th. 1"

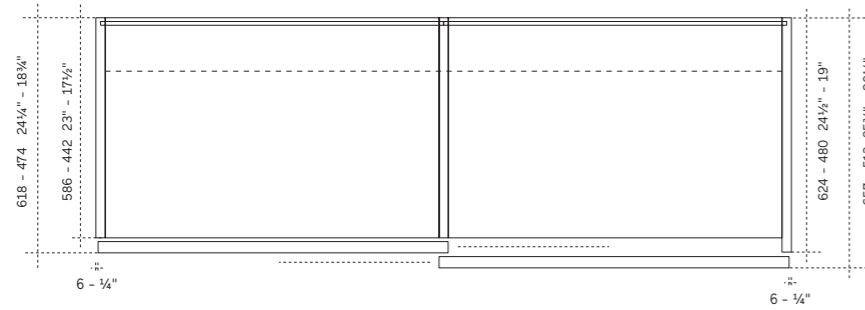

Sezione per anta NAICA sp. 28 - th. 1"

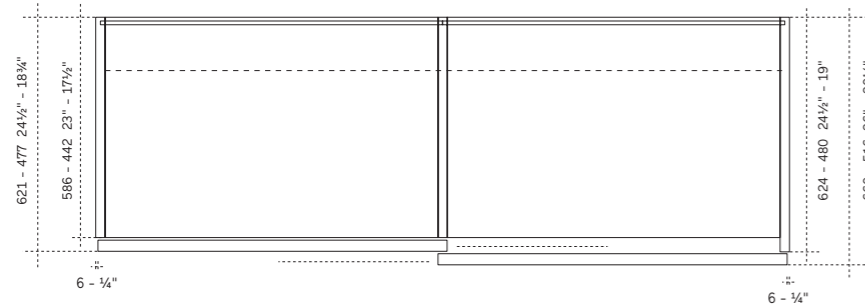

Sezione per anta WARM sp. 30 - th. 1 1/4"

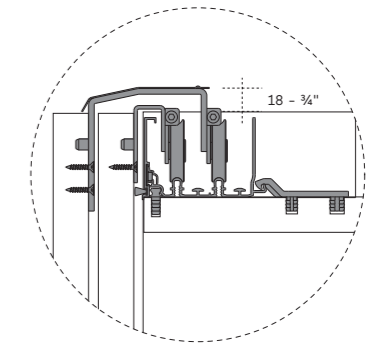
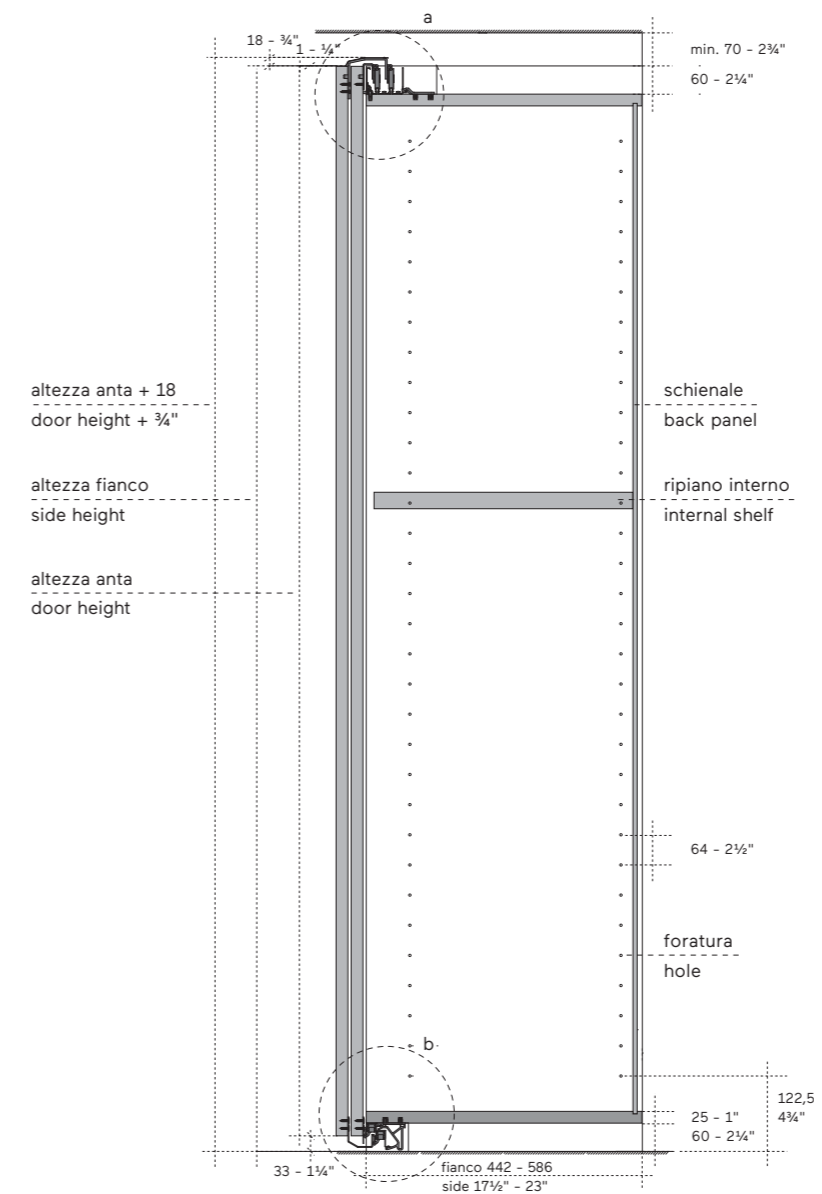
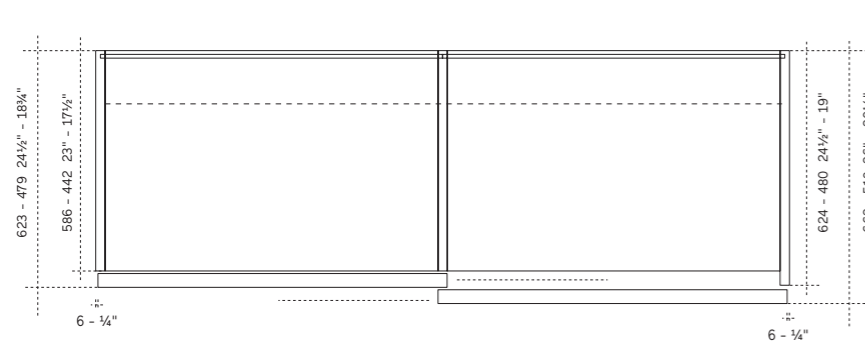

a. Sezione binario superiore
Section of upper rail

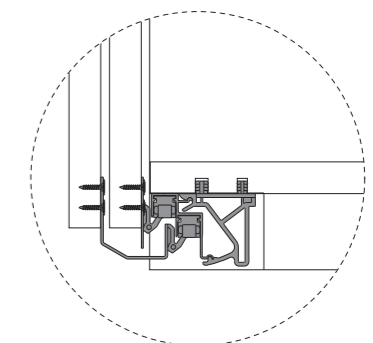

b. Sezione binario inferiore
Section of lower rail

Spazio per montaggio di serie
Space for standard installation

In altezza mm. 70 in più dell'altezza del fianco dell'armadio.
In larghezza mm. 50 in più della larghezza dell'armadio.
Su richiesta viene inserita la ferramenta speciale per il montaggio in nicchia

The height is 70 mm more than the height of the wardrobe side.
The width is 50 mm more than the width of the wardrobe.
Special fittings for niche assembly are available on request

Spazio per montaggio in nicchia
Space for installation in a recess

In altezza mm. 70 in più dell'altezza del fianco dell'armadio.
In larghezza mm. 15 in più della larghezza dell'armadio.

2 3/4" higher than the height of wardrobe side panel.
1/4" wider than the total width of wardrobe

Nota
Note

Per armadio con profondità 442 prevedere fissaggio a parete obbligatorio

Wardrobe with 17 1/2" depth must be fixed to wall

Ante complanari — Coplanar doors



Prima
p. 92

Text
p. 96

Ellevi
p. 104

Abaco — Abacus



Naica
p. 106

Emery
p. 110

Warm
p. 114

Ante complanari — Coplanar doors

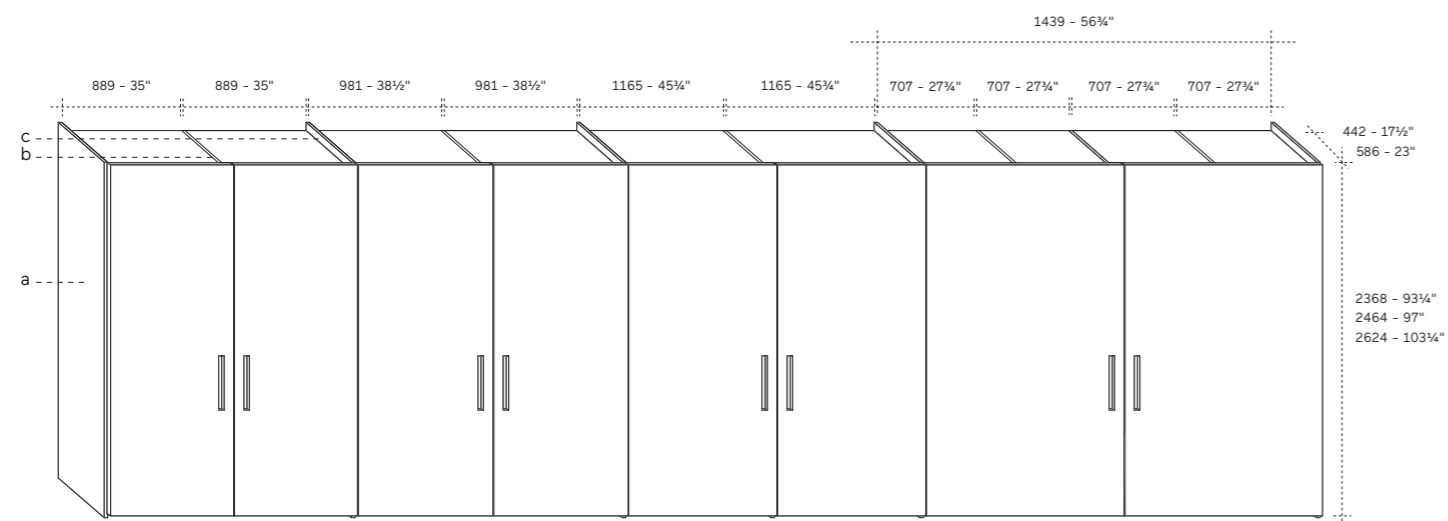

Armadio ante complanari
Coplanar doors wardrobe
 a. fianco esterno
 b. fianco interno
 c. fianco di collegamento

Dimensioni
Dimensions

4 larghezze
4 width
 889 - 981 - 1165 - 1439
 35" - 38½" - 45¼" - 56¼"

3 altezze
3 heights
 2368 - 2464 - 2624
 93¼" - 97" - 103¼"

2 profondità
2 depth
 442 - 586
 17½" - 23"

Nota
Note
 Il vano 1439 è suddiviso internamente in due vani da 707

Il vano 1439 è suddiviso internamente in due vani da 707



Ante complanari — Coplanar doors

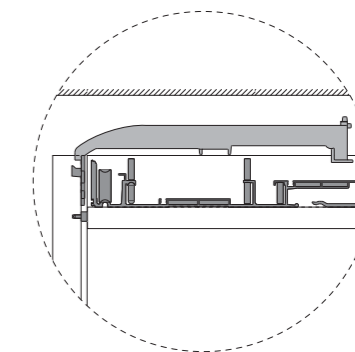
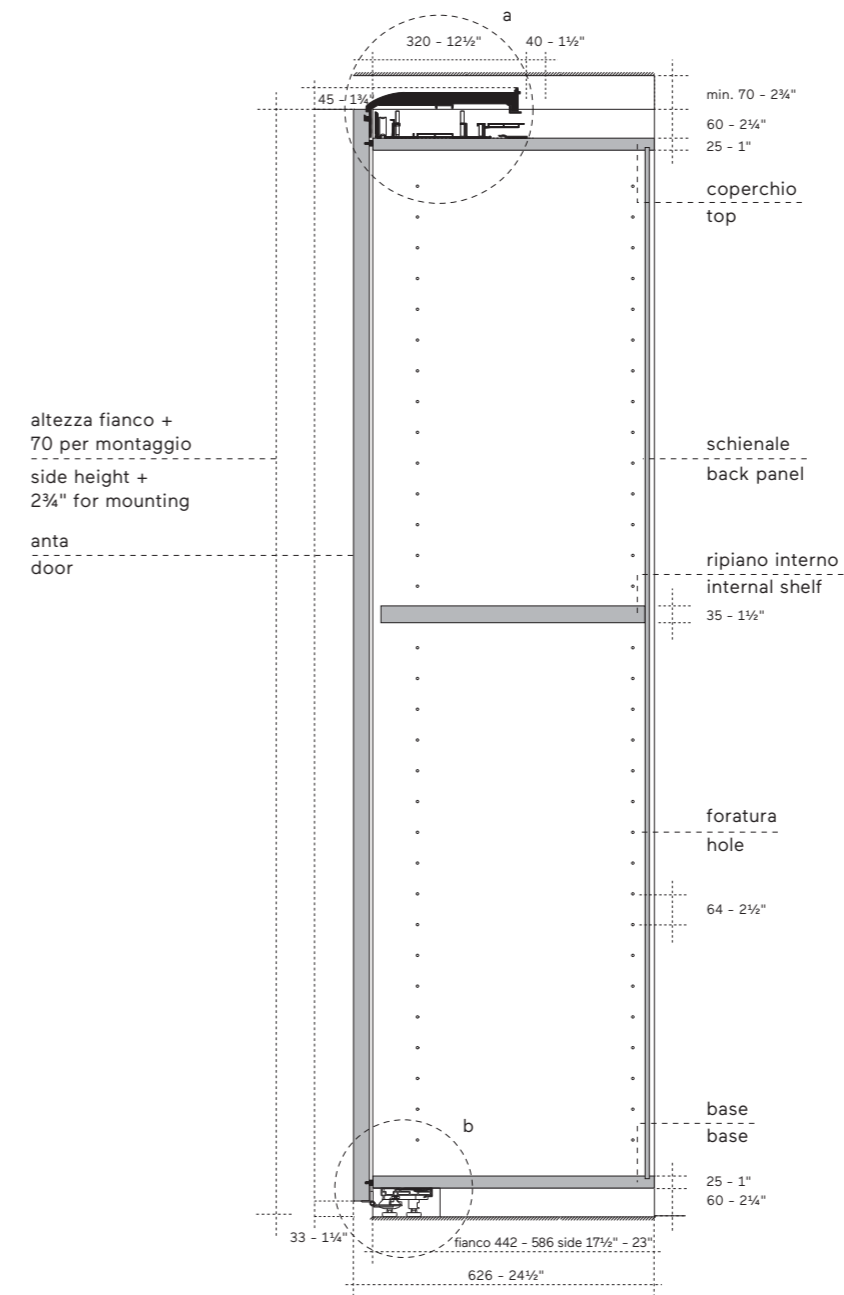
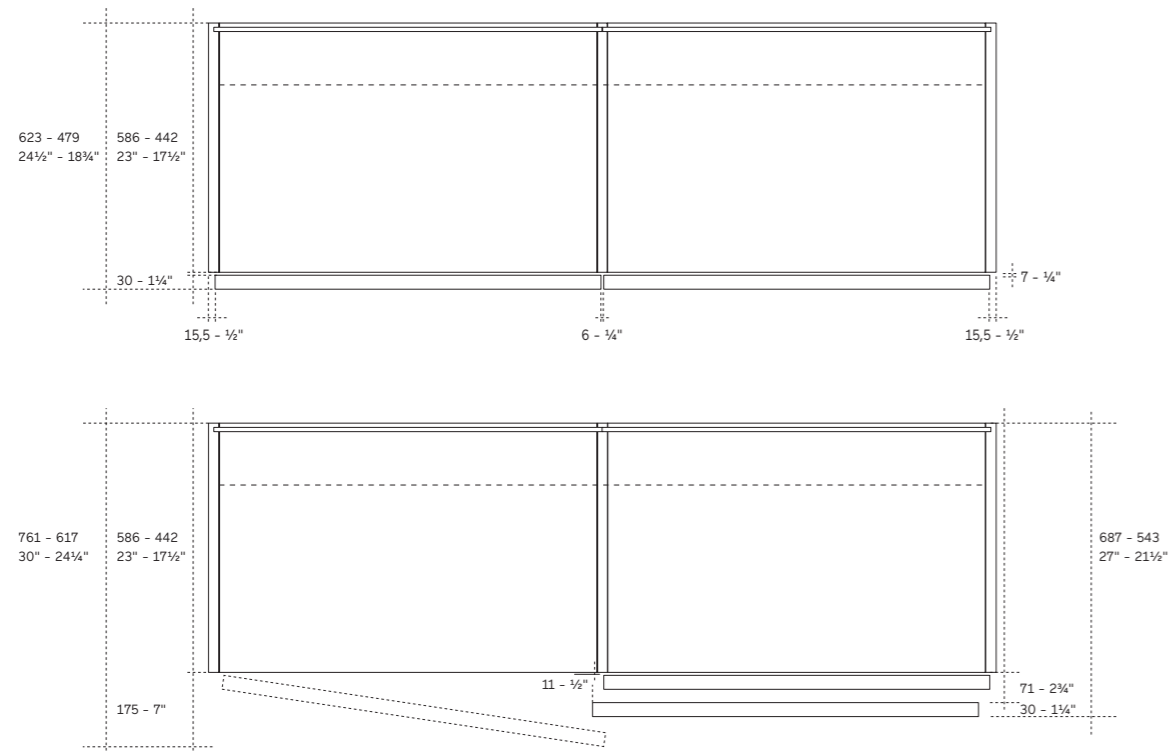

a
Sezione binario superiore
Section of upper rail

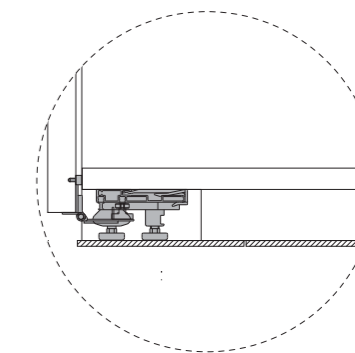

b
Sezione binario inferiore
Section of lower rail

Spazio per montaggio di serie
Space for standard installation
In altezza mm. 70 in più dell'altezza del fianco dell'armadio.
In larghezza mm. 50 in più della larghezza dell'armadio

2 3/4" more than the height of the side panel of the wardrobe
2" more than the width of the wardrobe

Spazio per montaggio in nicchia
Space for installation in a recess
In altezza mm. 70 in più dell'altezza del fianco dell'armadio.
In larghezza mm. 15 in più della larghezza dell'armadio

2 3/4" more than the height of the side panel of the wardrobe
2" more than the width of the wardrobe

Nota
Note
Per armadio con profondità 442 prevedere fissaggio a parete obbligatorio

Wardrobe with 17 1/2" depth must be fixed to wall

Tipologia ante — Type of doors

Leggerezza, eleganza, discrezione, raffinate tecnologie, per soluzioni estetiche impeccabili. Ogni armadio è realizzato con materiali scelti con cura e accostati con sapienza: colori chiari e scuri, rivestimenti lucidi e opachi, essenze materiche naturali. Le superfici sono pensate creativamente in funzione delle esigenze più personali così come le varie possibilità di apertura dal battente allo scorrevole fino al complanare. Le maniglie hanno l'impatto di ideogrammi su grandi pagine nitide. Le rifiniture sono di alta qualità perché Lema realizza ogni parte pensando all'armonia dell'insieme.

Lightness, elegance, discretion and sophisticated technology combine for impeccable aesthetic solutions. Every wardrobe is made using materials chosen with care and combined with an expert hand, with light and dark colours, glossy and matt finishings, natural material textures all featuring. Surfaces have been created to suit personalised requirements, with various types of doors available, including hinged, sliding and coplanar. Handles have the same impact as lone characters on large, blank pages. Finishes are of the highest quality, because Lema keeps the harmony of the whole in mind when designing each and every element.



Larghezze e altezze Widths and heights

Battente
Hinged

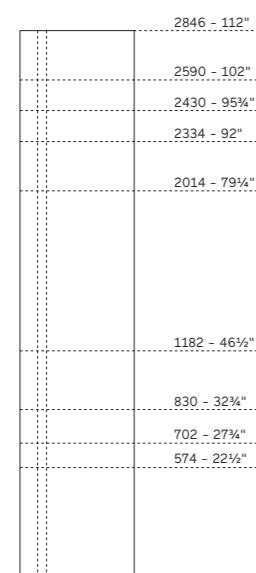

454 - 500 - 592
17 3/4" - 19 3/4" - 23 3/4"

Scorrevole
Sliding

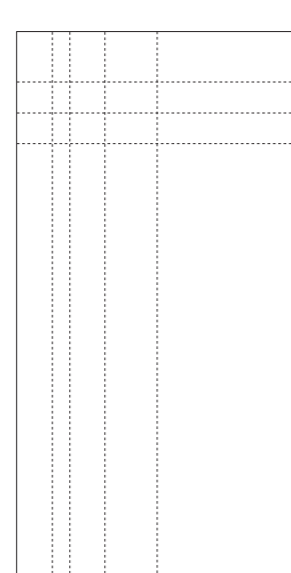

750 - 932 - 1024 - 1208 - 1482*
29 1/4" - 36 3/4" - 40 3/4" - 47 1/2" - 58 1/4"*

Complanare
Coplanar

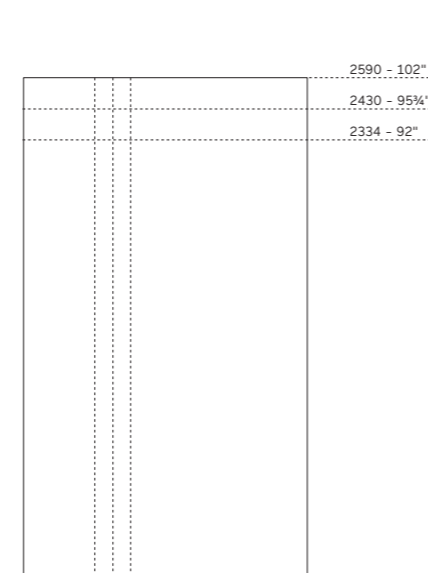

908 - 1000 - 1184 - 1458
35 3/4" - 39 3/4" - 46 1/4" - 57 1/2"

Dettaglio anta Door detail

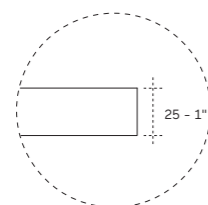

Maniglia per battente
Handle for hinged door
CHO2 (chiave - key)
MA01 - MA02 - MA03 -
MA10 - MA12 - MA25 -
MA33 - MA40 - MA53 -
MA56 - MA58 -
MA81 - MA92 - MA45 -
MA46 - MT40

Maniglia per scorrevole
Handle for sliding doors
a gancio in metallo
verniciato
alluminio M405

latch handle metal
painted aluminium M405

Maniglia per complanare
Handle for coplanar
MA40 (orizzontale/
Horizontal)
MA92

Collezione maniglie
Handles collection
Pag. 118
On p. 118

Cerniera
Hinge
Standard 94° - 165°

Adattabilità
Adaptability

Ante battenti riducibili
in larghezza, altezza
e taglio inclinato.
Ante scorrevoli riducibili
in larghezza e altezza.
Ante complanari riducibili
in altezza

Hinged doors available
with reduced width,
height and angled cut.
Width and height
of sliding doors can
be reduced. Height
of coplanar doors can
be reduced

Informazioni utili
Useful information

Ante battenti disponibili
per colonne ad angolo,
colonne terminali,
armadio sovrapposto
passaggio porta e ponte
armato.

Nel vano a due ante e
nella colonna ad angolo,
la maniglia è prevista
solo sull'anta di destra

Hinged door available
for corner columns, end
columns, overlapping
wardrobe, passage door
and door bridge solution.
In double and corner
columns, the handle is
provided on the right
door only

Nota
Note

Finitura laccato lucido
non disponibile per anta
larghezza 1482 e 1458

Glossy lacquered
finishing not available
for door width 1482 and
1458

*

Larghezza 1482
scorrevole non
disponibile per altezza
2846

Width 1482 sliding door
not available for height
2846

Design:
Officinadesign Lema



Finiture anta
Door finishings

Melaminico
Melamine



Canvas



Lino



Visone

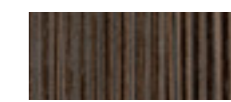

Larice moka
Moka larch



Larice sbiancato
Bleached larch

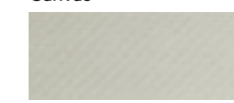

Gobi

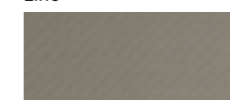

Sahara

Essenze -
Venatura verticale
Woods -
Vertical veining



Rovere carbone
Carbone oak



Rovere termotrattato
Heat-treated oak



Noce-L
L-walnut

Lemacolortrend - LCT
Laccato opaco
Matt lacquered

colori pag. 132 - 133
colours on p. 132 - 133

Lemacolorlucido - LCL
Laccato lucido
Glossy lacquered

colori pag. 134
colours on p. 134

Flago

Larghezze e altezze Widths and heights

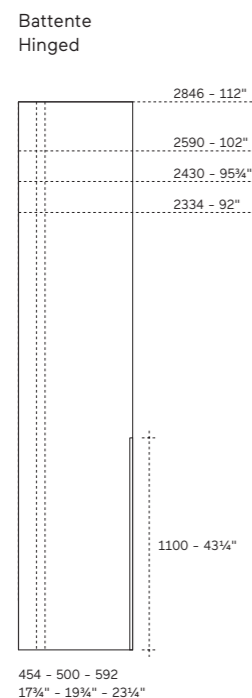

Dettaglio anta Door detail

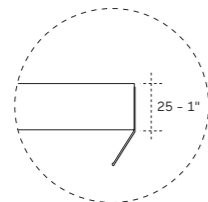

Finiture maniglia Handle finishings

Metallo verniciato:
bronzo epox M421
bronzo palladio M491
laccato opaco LCT

Metal painted:
bronze epox M421
palladio M491
matt lacquered LCT

Cerniera Hinge

Standard 94°-165°

Adattabilità Adaptability

Riducibile in larghezza,
altezza e taglio inclinato

Reduced width, height
and angled cut available

Informazioni utili Useful information

Disponibile per colonne
ad angolo e colonne
terminali. Nel vano
a due ante è possibile
richiedere la maniglia
solo sull'anta di destra.
Nella colonna ad angolo,
la maniglia è prevista
solo sull'anta di destra

Available for corner
columns and end
columns. In the cabinet
with two doors, a handle
positioned on the right
door only can be
requested.
In two doors and corner
columns, the handle
is provided on the right
door only

Design:
Officinadesign Lema



Finiture anta Door finishings

Melaminico Melamine



Canvas



Lino



Visone

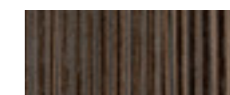

Larice moka
Moka larch



Larice sbiancato
Bleached larch



Gobi



Sahara

Essenze - Venatura verticale Woods - Vertical veining



Rovere carbone
Carbone oak



Rovere termotrattato
Heat-treated oak



Noce-L
L-walnut

Lemacolorrend - LCT Laccato opaco Matt lacquered

colori pag. 132 - 133
colours on p. 132 - 133

Lemacolorlucido - LCL Laccato lucido Glossy lacquered

colori pag. 134
colours on p. 134

Larghezze e altezze
Widths and heights

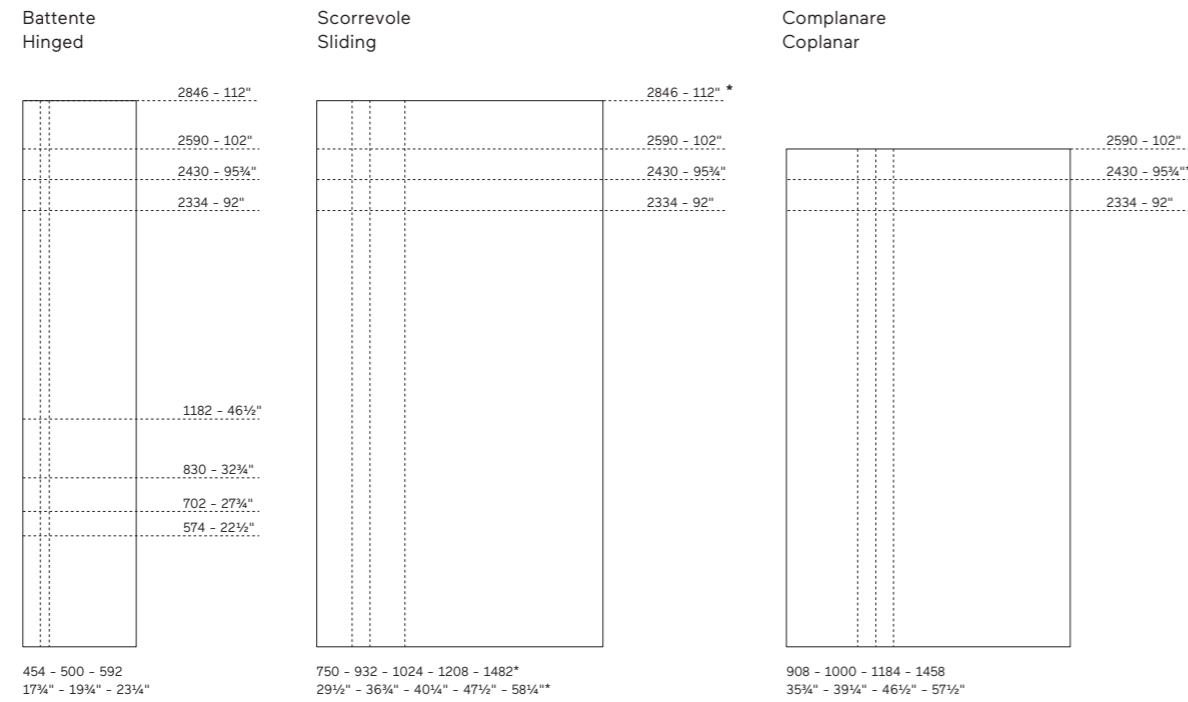

Dettaglio anta
Door detail

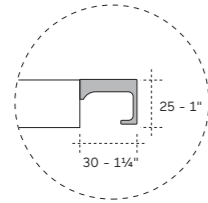

Finiture maniglia
Handle finishings

Metallo verniciato:
bronzo epox M421
laccato opaco LCT

Metal painted:
bronze epox M421
matt lacquered LCT

Cerniera
Hinge

Standard 94°-165°

Adattabilità
Adaptability

Ante battenti e ante scorrevoli riducibili in larghezza e altezza. Ante complanari riducibili in altezza

Width and height of both hinged and sliding doors can be reduced

Informazioni utili
Useful information

Anta battente disponibile per colonne ad angolo, colonne terminali e armadio sovrapposto. Nel vano a due ante e nella colonna ad angolo il profilo-maniglia è previsto solo sull'anta di destra

Le ante scorrevoli interne hanno il profilo-maniglia su un lato lungo, le ante esterne hanno il profilo-maniglia su entrambi i lati lunghi

Le ante complanari hanno il profilo-maniglia su un solo lato lungo

Hinged door available for corner columns, end columns overlapping wardrobe. In two doors and corner columns, the handle is provided on the right door only

Internal sliding doors have handle profiles on one long side, while external doors have handle profiles on both long sides

Coplanar doors have handle profiles on one long side

Nota
Note

Finitura laccato lucido non disponibile per anta larghezza 1482 e 1458

Glossy lacquered finishing not available for door width 1482 and 1458

*

Larghezza 1482 scorrevole non disponibile per altezza 2846

Width 1482 sliding door not available for height 2846

Design:
Officinadesign Lema



Finiture anta
Door finishings

Melaminico
Melamine



Canvas



Lino



Visone

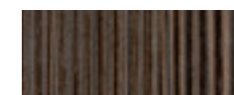

Larice moka
Moka larch



Larice sbiancato
Bleached larch

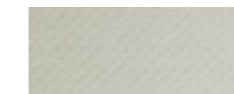

Gobi

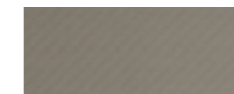

Sahara

Argille
Clays



Ardesia G116

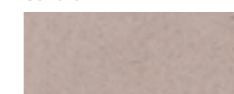

Creta G101

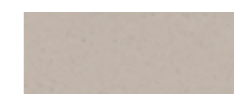

Polvere G111



Sabbia G106



Pece G126

Essenze - Venatura verticale
Woods - Vertical veining



Rovere carbone
Carbone oak



Rovere termotrattato
Heat-treated oak



Noce-L
L-walnut

Lemacolortrend - LCT
Laccato opaco
Matt lacquered

colori pag. 132 - 133
colours on p. 132 - 133

Lemacolorlucido - LCL
Laccato lucido
Glossy lacquered

colori pag. 134
colours on p. 134

Larghezze e altezze
Widths and heights

Battente
Hinged

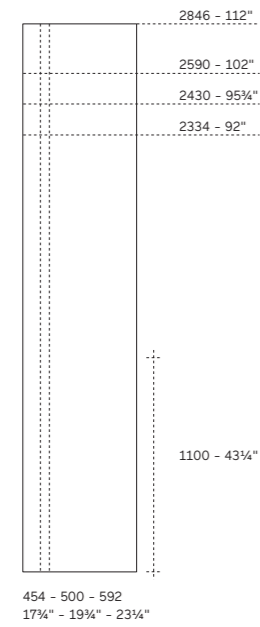

Dettaglio anta
Door detail

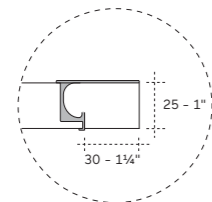

Finiture maniglia
Handle finishings

Metallo verniciato:
bronzo epox M421
laccato opaco LCT

Metal painted:
bronze epox M421
matt lacquered LCT

Cerniera
Hinge

Standard 94°-165°

Adattabilità
Adaptability

Riducibile in larghezza,
altezza e taglio inclinato

Reduced width, height
and angled cut available

Informazioni utili
Useful information

Disponibile per colonne
ad angolo e colonne
terminali.

Nel vano a due ante e
nella colonna ad angolo
la maniglia è prevista
solo sull'anta di destra.

Non è possibile il
montaggio della maniglia
su entrambe le ante

Available for corner
columns and end
columns.

In the cabinet with two
doors and in the corner
column, a handle
is positioned on the right
door only.

Handle cannot be fitted
on both doors

Design:
Officinadesign Lema



Finiture anta
Door finishings

Melaminico
Melamine



Canvas



Lino



Visone

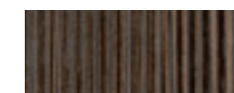

Larice moka
Moka larch



Larice sbiancato
Bleached larch



Gobi

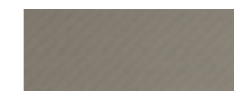

Sahara

Essenze -
Venatura verticale
Woods -
Vertical veining



Rovere carbone
Carbone oak



Rovere termotrattato
Heat-treated oak



Noce-L
L-walnut

Lemacolortrend - LCT
Laccato opaco
Matt lacquered

colori pag. 132 - 133
colours on p. 132 - 133

Elegant

Larghezze e altezze Widths and heights

Battente
Hinged

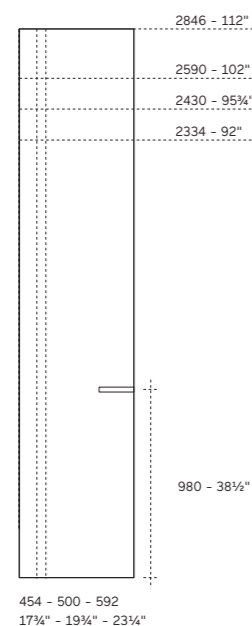

Dettaglio anta Door detail

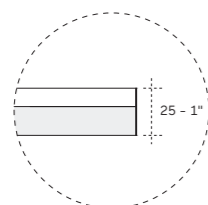

Maniglia
Handle
Incassata
Recessed

Finiture fondo maniglia
Handle recess finishings
Laccato LCT o LCL
Essenza rovere carbone
Essenza rovere
termotrattato
Essenza Noce-L

Lacquered LCT or LCL
Oak carbone
Oak heat-treated
L-walnut

Dimensioni maniglia
(L x H)
Handles dimensions
(W x H)
200 x 93
7 3/4" x 3 3/4"

Cerniera
Hinge
Standard 94°-165°

Adattabilità
Adaptability
Riducibile in larghezza,
altezza e taglio inclinato

Reduced width, height
and angled cut available

Informazioni utili
Useful information
Disponibile per colonne
ad angolo e colonne
terminali.
Nella colonna ad angolo,
la maniglia è prevista
solo sull'anta di destra

Available for corner
columns and end
columns.
In the corner column,
the handle is provided
on the right door only

Design:
Officinadesign Lema



Finiture anta
Door finishings

Lemacolortrend - LCT colori pag. 132 - 133
Laccato opaco colours on p. 132 - 133
Matt lacquered

Lemacolorlucido - LCL colori pag. 134
Laccato lucido colours on p. 134
Glossy lacquered

Larghezze e altezze
Widths and heights

Battente
Hinged

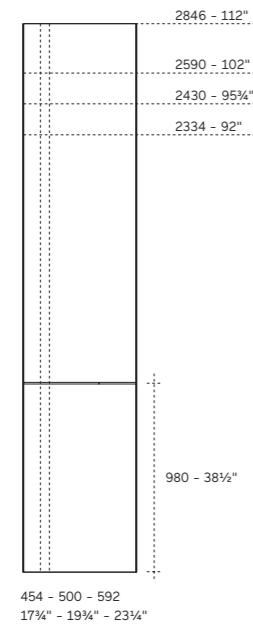

Dettaglio anta
Door detail

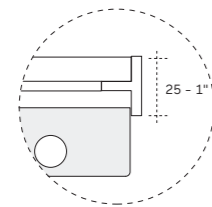

Finiture profilo e maniglia e maniglia
Profile and handle finishings
Metallo verniciato bronzo M420

Metal bronze painted M420

Dimensioni maniglia (L x P)
Handles dimensions (W x D)
192 x 25
7 1/2" x 1"

Cerniera Hinge
Standard 94°-165°

Adattabilità Adaptability
Possibile riduzione in larghezza e altezza

Reduction in width and height possible

Informazioni utili Useful information
Disponibile per colonne ad angolo e colonne terminali.
Nella colonna ad angolo, la maniglia è prevista solo sull'anta di destra

Available for corner columns and end columns.
In the corner column, the handle is provided on the right door only

Design:
David Lopez Quincoces

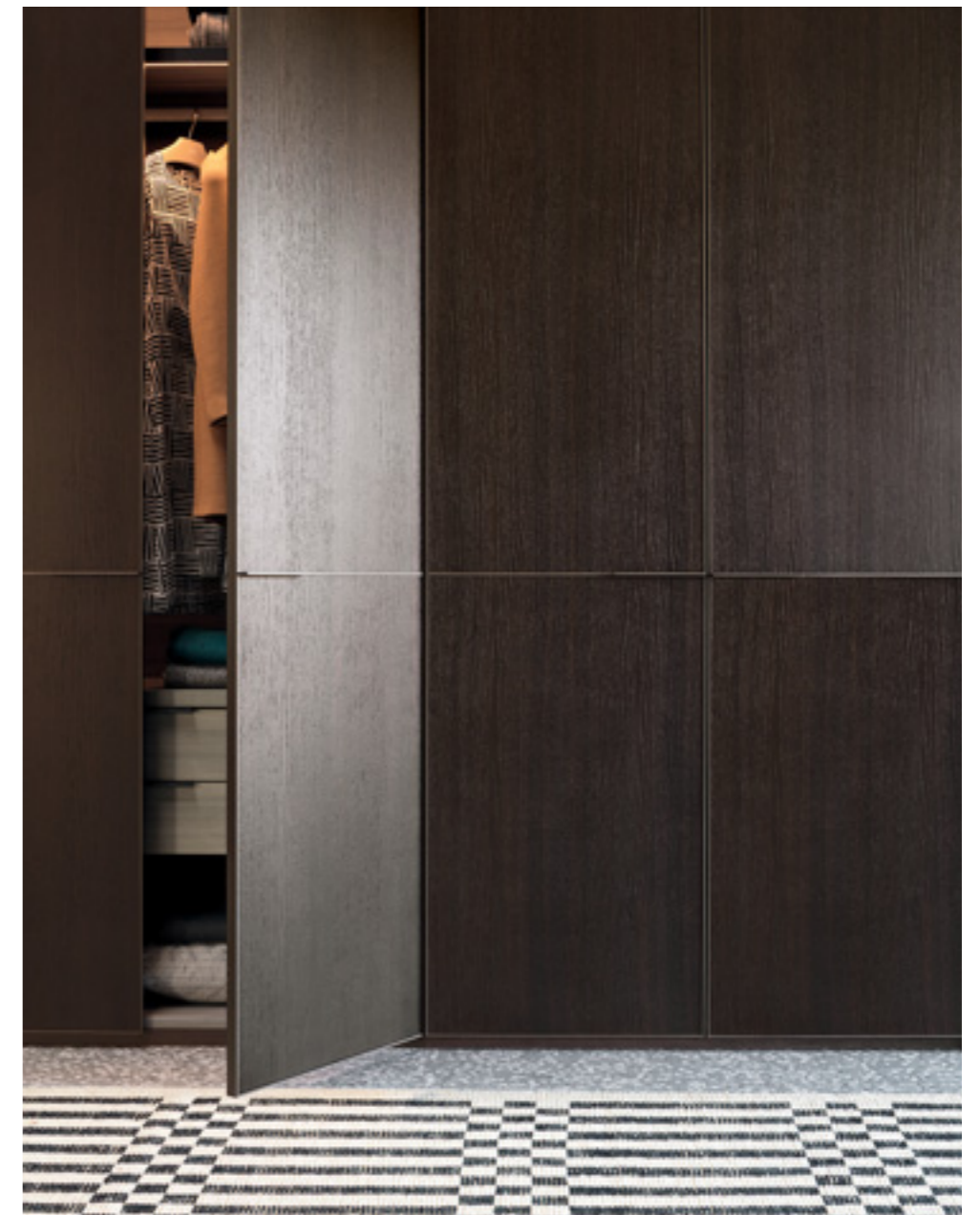

Finiture anta
Door finishings

Essenze - Venatura verticale
Woods - Vertical veining

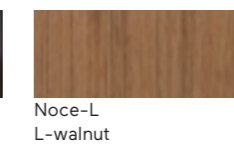
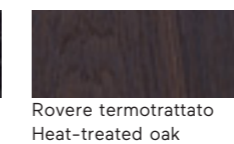

Essenze - Venatura orizzontale
Woods - Horizontal veining



Lemacolortrend - LCT
Laccato opaco
Matt lacquered
colori pag. 132 - 133
colours on p. 132 - 133

Larghezze e altezze
Widths and heights

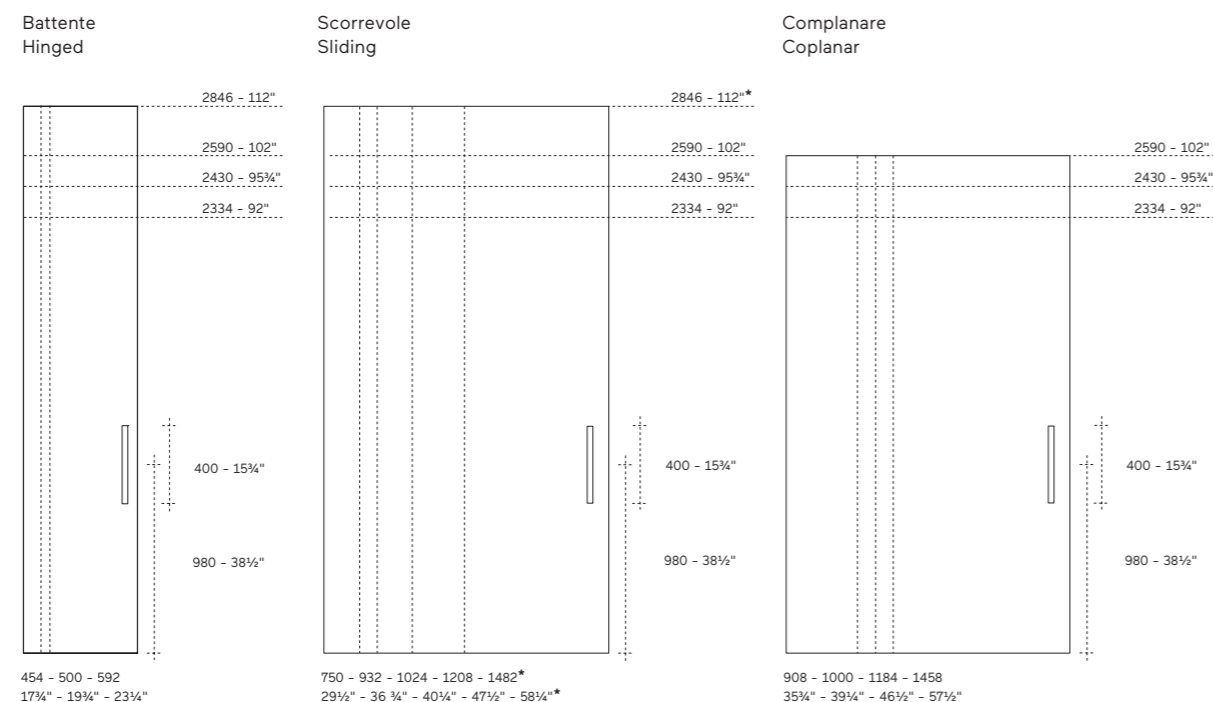

Dettaglio anta
Door detail

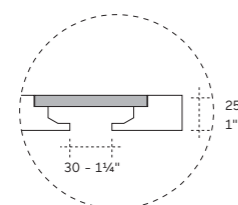

Maniglia
Handle

Incassata
Recessed

Finiture fondo maniglia
Handle recess finishings

Laccato LCT o LCL
Essenza rovere carbone
Essenza rovere
termotrattato
Noce-L

Lacquered LCT or LCL
Oak carbone
Oak heat-treated
L-walnut

Dimensioni maniglia
(L x H)

Handles dimensions
(W x H)
30 x 400
1 1/4" x 15 3/4"

Cerniera
Hinge

Standard 94°-165°

Adattabilità
Adaptability

Ante battenti riducibili in larghezza, altezza e taglio inclinato.
Ante scorrevoli riducibili in larghezza e altezza.
Ante complanari riducibili in altezza

Hinged doors available with reduced width, height and angled cut.
Width and height of sliding doors can be reduced.
Height of coplanar doors can be reduced

Informazioni utili
Useful information

Anta battente disponibile per colonne ad angolo e colonne terminali

Hinged door available for corner columns and end columns

Nota
Note

Finitura laccato lucido non disponibile per anta larghezza 1482 e 1458

Glossy lacquered finishing not available for door width 1482 and 1458

*

Larghezza 1482 scorrevole non disponibile per altezza 2846

Width 1482 sliding door not available for height 2846

Finiture anta
Door finishings

Lemacolor trend - LCT colori pag. 132 - 133
Laccato opaco colours on p. 132 - 133
Matt lacquered

Lemacolor lucido - LCL colori pag. 134
Laccato lucido colours on p. 134
Glossy lacquered



Larghezze e altezze Widths and heights

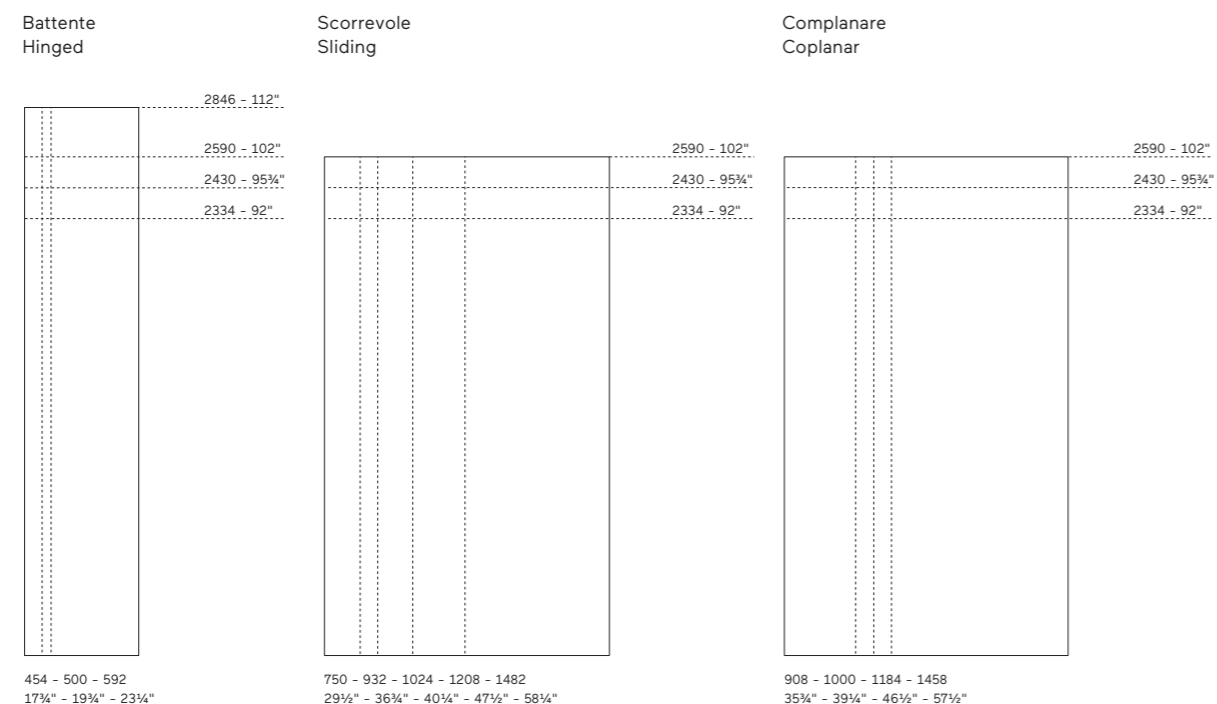

Dettaglio anta Door detail

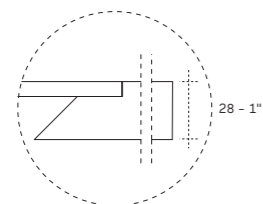

Maniglia Handle Incassata Recessed

**Finiture fondo maniglia
Handle recess finishings**
Metallo verniciato:
laccato opaco LCT
bronzo M420
bronzo epox M421

Metal painted:
matt lacquered LCT
bronze M420
bronze epox M421

Cerniera Hinge

Standard 94°-165°

Adattabilità Adaptability

Ante battenti e scorrevoli
riducibili in larghezza
e altezza.
Ante complanari riducibili
in altezza

Width and height of both
hinged and sliding doors
can be reduced.
Height of coplanar doors
can be reduced

Informazioni utili Useful information

Nel vano a due ante
battenti e nella colonna
ad angolo la maniglia è
prevista solo sull'anta
di destra

In composizioni con ante
scorrevoli la maniglia è
prevista su ogni anta,
posizionata sul lato
opposto alla direzione
di scorrimento

In composizioni con ante
complanari la maniglia
è prevista su ogni anta,
posizionata sullo stesso
lato della direzione
di scorrimento

Anta battente disponibile
per colonne ad angolo

In two doors and corner
columns, the handle
is provided on the right
door only

Where sliding doors
are present, the handle
is positioned on both
doors, on the opposite
side to the sliding
direction

Where coplanar doors
are present, the handle
is positioned on both
doors, on the same side
as the sliding direction

Hinged door available for
corner columns

Abbinamenti consigliati Recommended combinations

Anta Door

Laccato LCT
Noce-L
Rovere Carbone /
Termotrattato

Matt lacquered LCT
L-walnut
Carbone / Heat-treated
oak

Fondo maniglia Handle recess

Metallo verniciato LCT
Metallo verniciato bronzo M420
Metallo verniciato bronzo
epox M421

Metal painted LCT
Metal painted bronze M420
Metal painted bronze epox
M421



Finiture anta Door finishings

Essenze - Venatura verticale Woods - Vertical veining



Rovere carbone
Carbone oak



Rovere termotrattato
Heat-treated oak



Noce-L
L-walnut

Lemacolorrend - LCT Laccato opaco Matt lacquered

colori pag. 132 - 133
colours on p. 132 - 133

Larghezze e altezze
Widths and heights

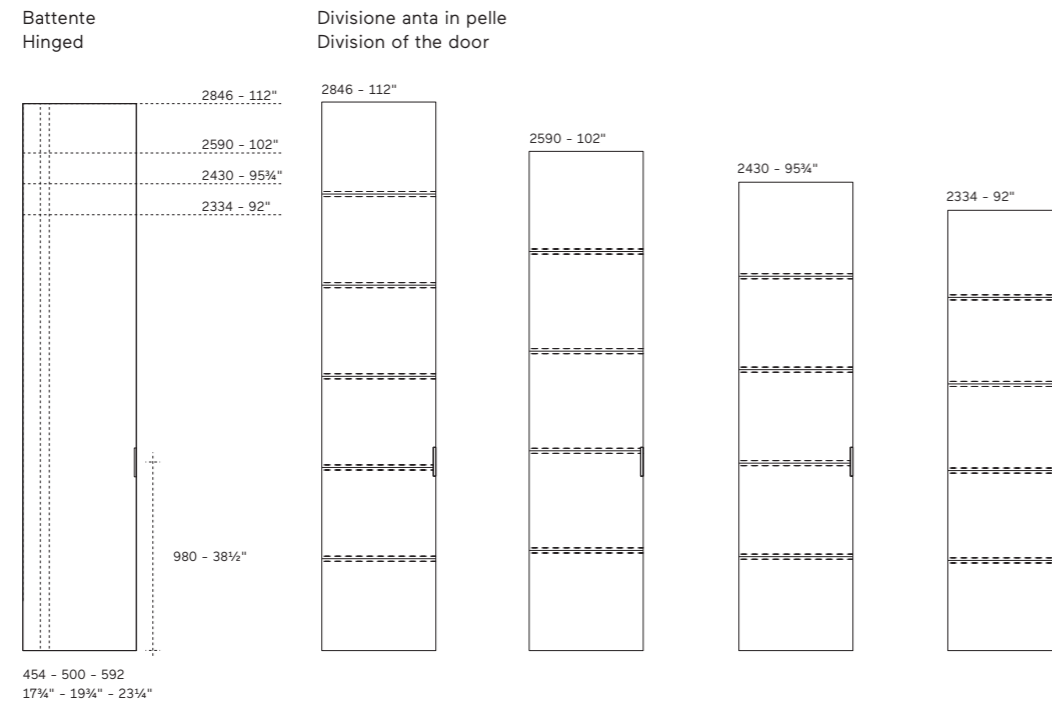

Dettaglio anta
Door detail

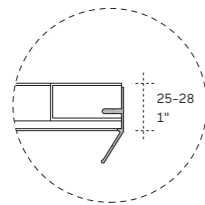

Finiture profilo e maniglia
Profile and handle finishings

Metallo verniciato:
sand epox M455
bronzo M420
laccato opaco LCT

Metal painted:
sand epox M455
bronze M420
matt lacquered LCT

Cerniera
Hinge

Standard 94° - 165°

Adattabilità
Adaptability

Riducibile in larghezza e altezza

Width and height can be reduced

Informazioni utili
Useful information

Disponibile per colonne ad angolo.

Nella colonna ad angolo, la maniglia è prevista solo sull'anta di destra

Available for corner columns.

In the corner column, the handle is provided on the right door only

Finitura interno anta
Finishing inner door

Anta
Door
Specchio
Vetro laccato
Tessuto / pelle

Mirror
Lacquered glass
Fabric / leather

Interno
Inner

Pellicola grigio antracite
Retrolaccatura del vetro
Melaminico struttura armadio

Charcoal grey film
back-lacquered glass
wardrobe structure
in melamine

Finiture anta
Door finishings

Vetri speciali
Special glass



Specchio - Mirror



Specchio bronzo
Bronze mirror

Vetri laccati
Lacquered glass

colori pag. 138
colours on p. 138

Tessuti a campionario
Fabric sample

Cat. cliente - client
Cat. TDA
Cat. TDB
Cat. TDC
Cat. TDD
Cat. TDE

Pelle a campionario
Leather sample

Cat. BASIC
Cat. SUPER
Cat. TOP (Solo versione Cervo / Solely Cervo version)

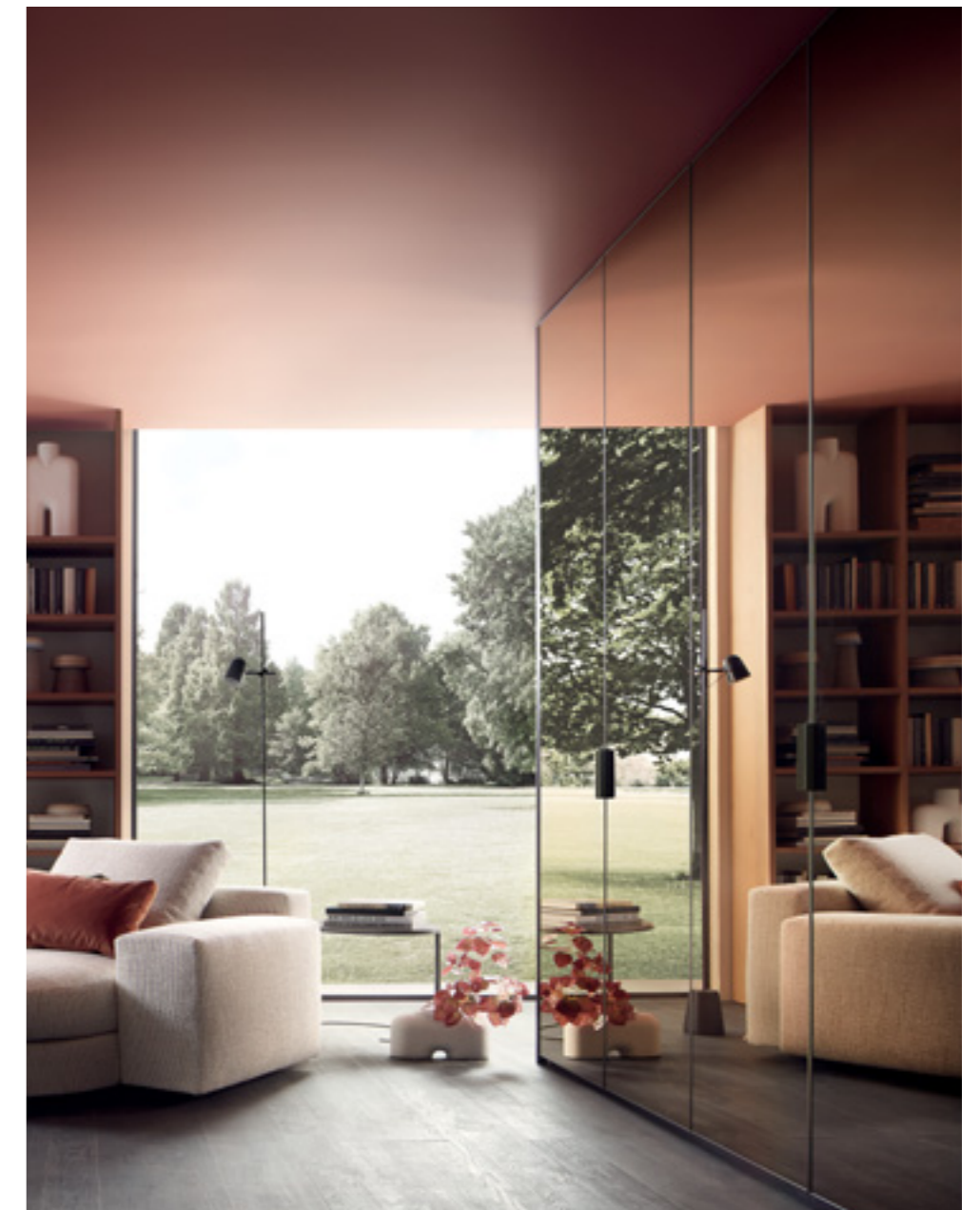

Larghezze e altezze
Widths and heights

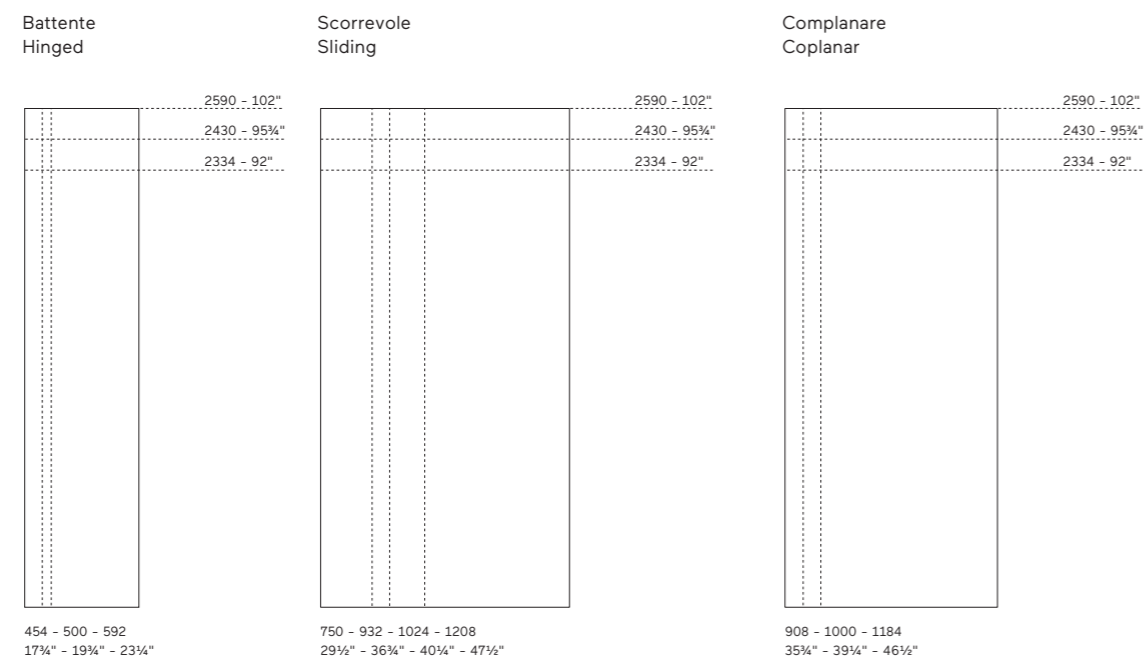

Dettaglio anta
Door detail

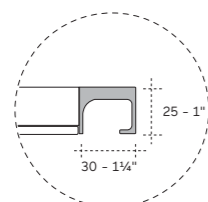

Finiture profilo e maniglia
Profile and handle finishing

Metallo verniciato:
Bronzo epox M421
Laccato opaco LCT

Metal painted:
Bronzo epox M421
Matt lacquered LCT

Abbinamento anta-maniglia
Door-handle combination

Ematite V260 - LCT 918
Talco V210 - LCT 700
Giada V240 - LCT 479
Iridio V250 - LCT 920

Cerniera
Hinge

Standard 94°-165°

Adattabilità
Adaptability

Ante battenti e ante scorrevoli riducibili in larghezza e altezza. Ante complanari riducibili in altezza

Width and height of both hinged and sliding doors can be reduced. Height of coplanar doors can be reduced

Informazioni utili
Useful information

Anta battente disponibile per colonne ad angolo, colonne terminali

Nel vano a due ante e nella colonna ad angolo il profilo maniglia è previsto solo sull'anta di destra

Le ante scorrevoli interne hanno il profilo-maniglia su un lato lungo, le ante esterne hanno il profilo-maniglia su entrambi i lati lunghi

Le ante complanari hanno il profilo-maniglia su un solo lato lungo

Hinged door available for corner columns, end columns

In two doors and corner columns, the handle is provided on the right door only

Internal sliding doors have handle profiles on one long side, while external doors have handle profiles on both long sides

Coplanar doors have handle profiles on one long side

Finitura interno anta
Finishing inner door

Anta Door

Specchio
Vetro laccato
Vetro acidato retrolaccato

Mirror

Lacquered glass

Acid-etched back-lacquered glass

Interno Inner

Melaminico struttura armadio
Melaminico struttura armadio
Melaminico struttura armadio

Melamine panel as wardrobe structure

Melamine panel as wardrobe structure

Melamine panel as wardrobe structure

Finiture anta
Door finishings

Vetri speciali
Special glass



Specchio - Mirror



Specchio bronzo
Bronze mirror

Vetri acidati retrolaccati
Back-lacquered frosted glass



Ematite V260 (opaco/matt)



Talco V210 (opaco/matt)



Giada V240 (opaco/matt)



Iridio V250 (opaco/matt)

Vetri laccati
Lacquered glass

colori pag. 138
colours on p. 138



Dandy

Larghezze e altezze Widths and heights

Battente
Hinged

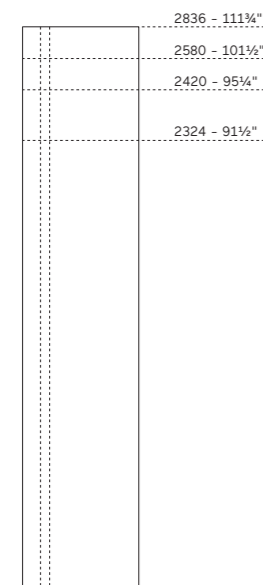

454 - 500 - 592
17 3/4" - 19 3/4" - 23 3/4"

Divisione anta in cuoio light
Division of the door in light hide

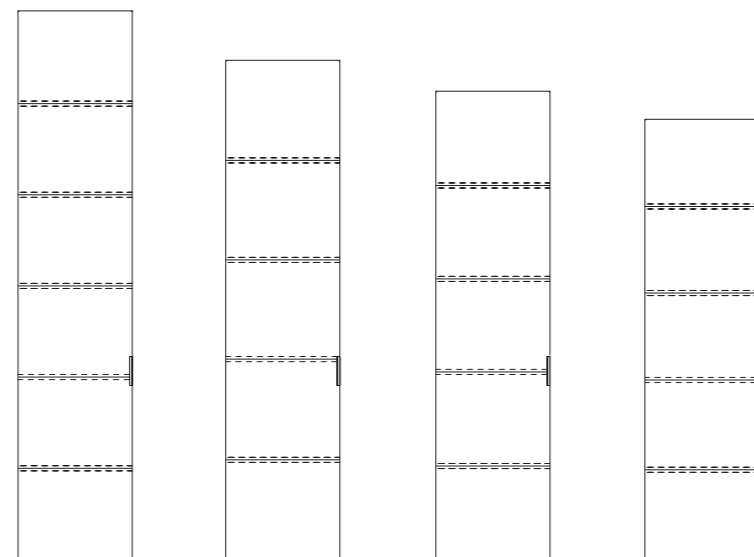

Dettaglio anta Door detail

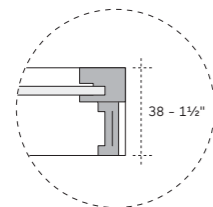

Finiture profilo, maniglia e cerniera Profile, handle and hinge finishings

Metallo verniciato:
bronzo epox M421
sand epox M455

Metal painted:
bronzo epox M421
sand epox M455

Cerniera

Hinge
Dandy 120°
Dandy 180° (opzionale)
per colonne singole
e doppie

Dandy 180°
per colonne angolari

Dandy 120°
Dandy 180° (optional)
for single and double
columns

Dandy 180° for corner
columns

Adattabilità Adaptability

Riducibile in larghezza
e altezza
Acid-etched back-
lacquered glass

Informazioni utili Useful information

Disponibile per colonne
ad angolo

Available for corner
columns

Finitura interno anta Finishing inner door

Anta

Door

Specchio
Vetro laccato
Decorativo tessile
Tessuto/pelle

Mirror
Lacquered glass
Inglese
Fabric/leather

Interno

Inner

Pellicola grigio antracite
Retrolaccatura del vetro
Melaminico struttura armadio
Melaminico struttura armadio

Charcoal grey film
Back-lacquered glass
Wardrobe structure in melamine
Wardrobe structure in melamine

Design:
Officinadesign Lema



Finiture anta Door finishings

Vetri speciali Special glass



Specchio - Mirror



Vetro bronzo serigrafato
Bronze glass with serigraphy



Vetro trasparente
Transparent glass

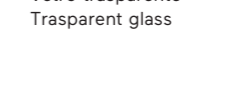

Vetro fumè grigio
Grey smoke glass

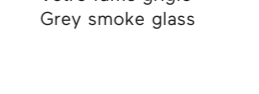

Vetro bronzo riflettente
Reflecting bronze glass

Cuoio light Light hide

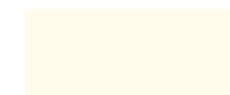

Bianco C04



Caffè C19



Avorio C28

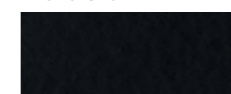

Nero C02



Tortora C29



Prugna C15



Naturale C26



Grigio C03

Rivestimento decorativo tessile Textile decorative covering

colori pag. 137
colours on p. 137

Vetri laccati Lacquered glass

colori pag. 138
colours on p. 138

Larghezze e altezze
Widths and heights

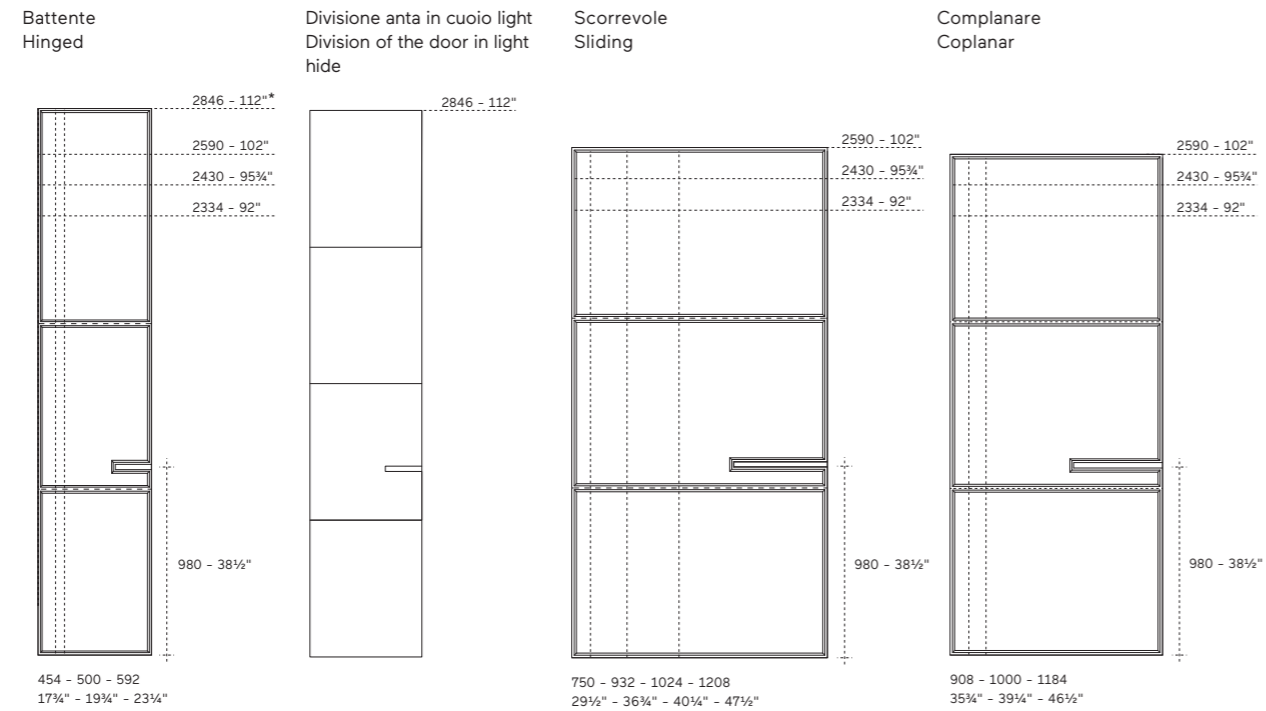

Dettaglio anta
Door detail

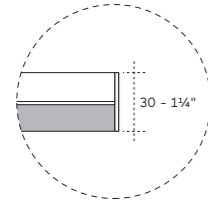

Maniglia
Handle
Incassata
Recessed

Finiture profilo e maniglia
Profile and handle finishings
Metallo anodizzato
Warm M103
Metal anodised
Warm M103

Dimensioni maniglia (L)
Handles dimensions (W)

Per anta battente inglese
189
7 1/2"

Per anta scorrevole inglese
375 - 466 - 512 - 604
14 3/4" - 18 3/4" - 20 1/4" - 23 3/4"

Per anta complanare inglese
454-500-592
17 3/4" - 19 3/4" - 23 3/4"

Cerniera
Hinge
Standard 94°-165°

Adattabilità
Adaptability
Non sono possibili riduzioni

Size reductions are not possible

Informazioni utili
Useful information
Disponibile per colonne ad angolo

Available for corner columns

Finitura interno anta
Finishing inner door

Anta
Door
Cuoio light
Light hide

Interno
Inner
Laccato colore struttura
Lacquered same colour melamine

Finiture anta
Door finishings

Cuoio light
Light hide



Seryasse

Larghezze e altezze Widths and heights

Battente
Hinged

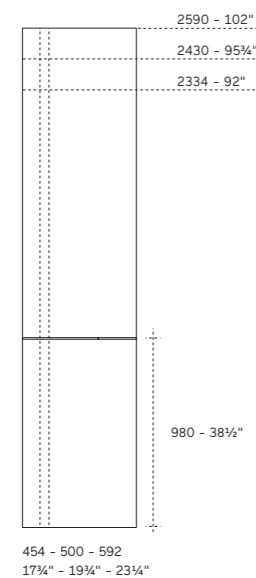

Dettaglio anta Door detail

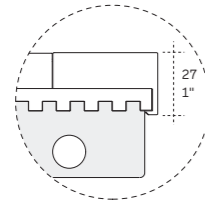

Finiture profilo e maniglia Profile and handle finishings

Metallo verniciato: bronzo M420

Metal bronze painted M420

Dimensioni maniglia (L x P) Handles dimensions (W x D)

192 x 25
7 1/2" x 1"

Cerniera Hinge

Standard 94°-165°

Adattabilità Adaptability

Possibile riduzione in altezza

Height can be reduced

Informazioni utili Useful information

Non disponibile per colonne ad angolo. Finitura consigliata per fianco esterno, fianco di finitura e profilo di finitura: metallo verniciato bronzo M420

Not available for corner columns. Recommended finishing for external side, finishing side and finishing profile: metal painted bronze M420

Finitura interno anta Finishing inner door

Anta Door

Noce canaletto

Canaletto walnut

Interno Inner

Laccato bronzo M420

Metal bronze painted M420

Design:
David Lopez Quincoes



Esenze - Venatura verticale Woods - Vertical veining

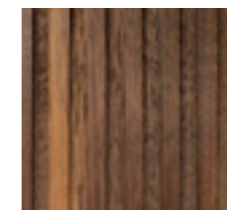

Noce canaletto a doghe
Slatted Canaletto walnut

Maniglie — Handles

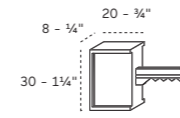
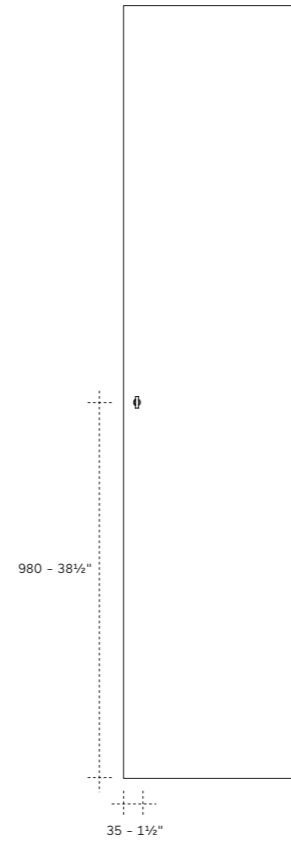

Chiave CH02 CH02 key

Finiture Finishings

Metallo verniciato
alluminio M405
Rivestimento cuoio light:
Bianco C04
Naturale invecchiato C26
Prugna C15
Nero C02

Metal aluminium
painted M405
Light hide coverings:
Bianco C04
Naturale invecchiato C26
Prugna C15
Nero C02

**Ante
Doors**
Prima
(battente - hinged)

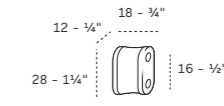
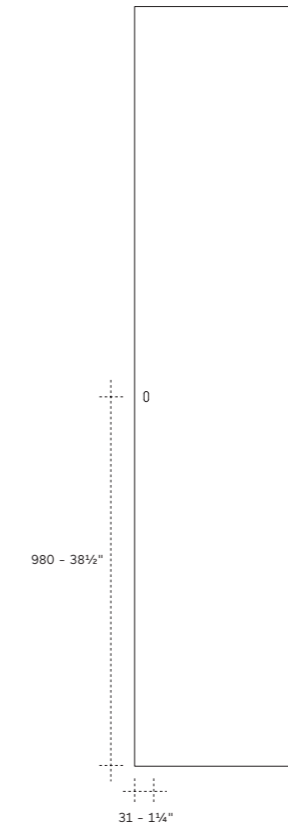

MA56

Finiture Finishings

Metallo cromato M200
Metal chromed M200

**Ante
Doors**
Prima
(battente - hinged)

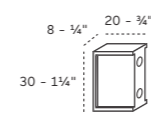
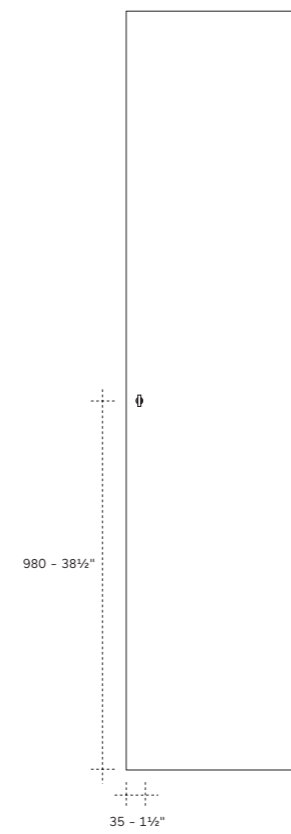

MA03

Finiture Finishings

Metallo verniciato
alluminio M405
Rivestimento cuoio light:
Bianco C04
Naturale invecchiato C26
Prugna C15
Nero C02

Metal aluminium
painted M405
Light hide coverings:
Bianco C04
Naturale invecchiato C26
Prugna C15
Nero C02

**Ante
Doors**
Prima
(battente - hinged)

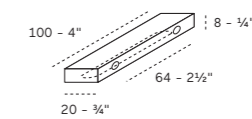
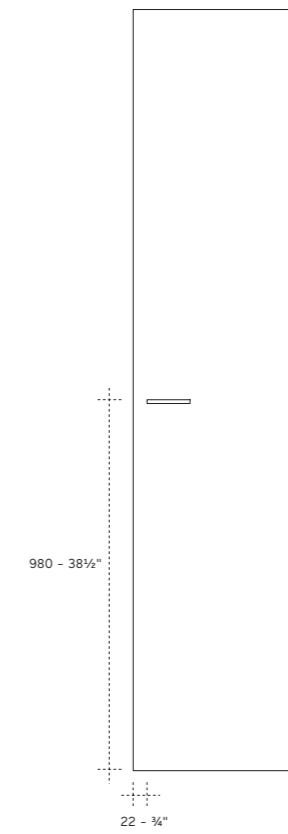

MA33

Finiture Finishings

Metallo verniciato
alluminio M405

Metal aluminium
painted M405

**Ante
Doors**
Prima
(battente - hinged)

Maniglie — Handles

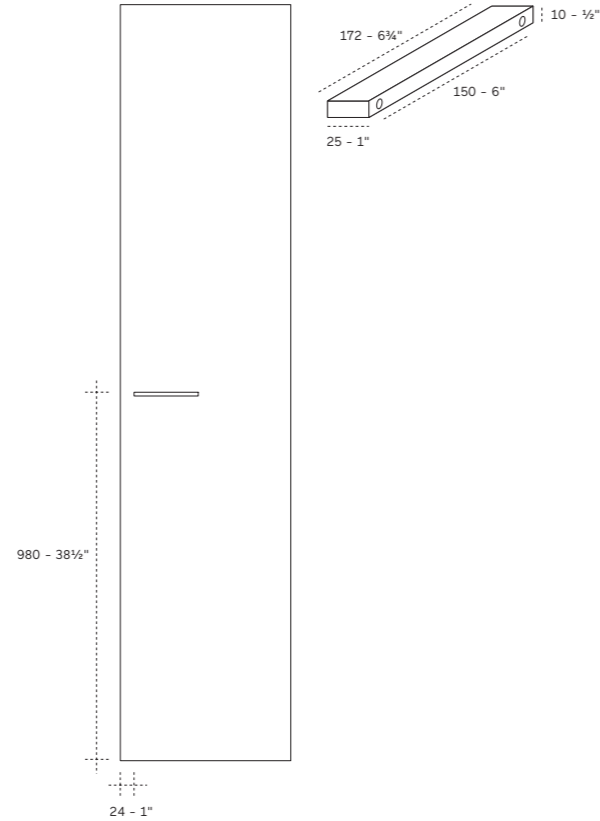

MA12

Finiture
Finishings
 Rovere carbone
 Rovere termotrattato
 Laccato opaco LCT

Carbone oak
 Heat-treated oak
 Lacquered LCT

Orientamento
Positioning
 Verticale - Orizzontale
 Vertical - Horizontal

Ante
Doors
 Prima
 (battente - hinged)

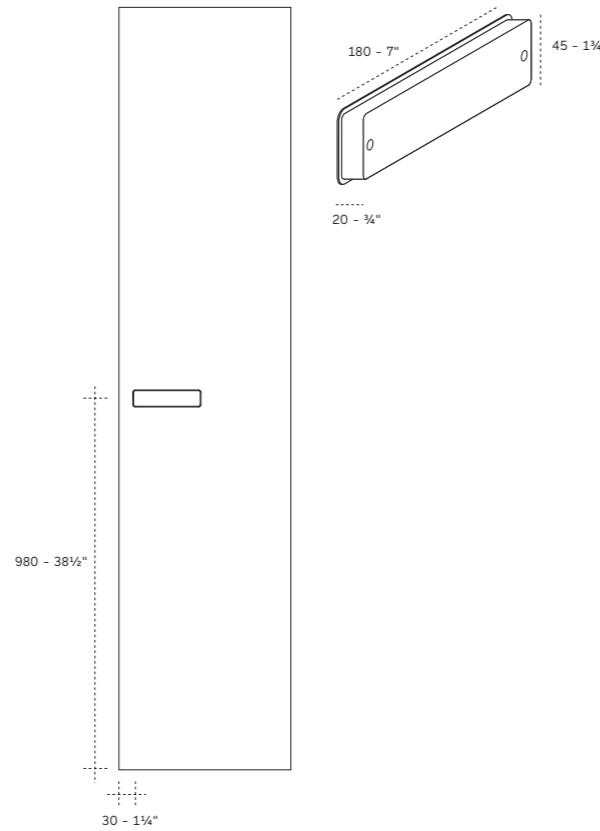

MA40

Finiture
Finishings
 Metallo verniciato:
 alluminio M405
 bianco M410 (RAL 9016)
 nero M440 (RAL 9005)
 bronzo M420

Painted metal:
 aluminium M405
 white M410 (RAL 9016)
 black M440 (RAL 9005)
 bronze M420

Ante
Doors
 Prima
 (battente e coplanare -
 hinged and coplanar)

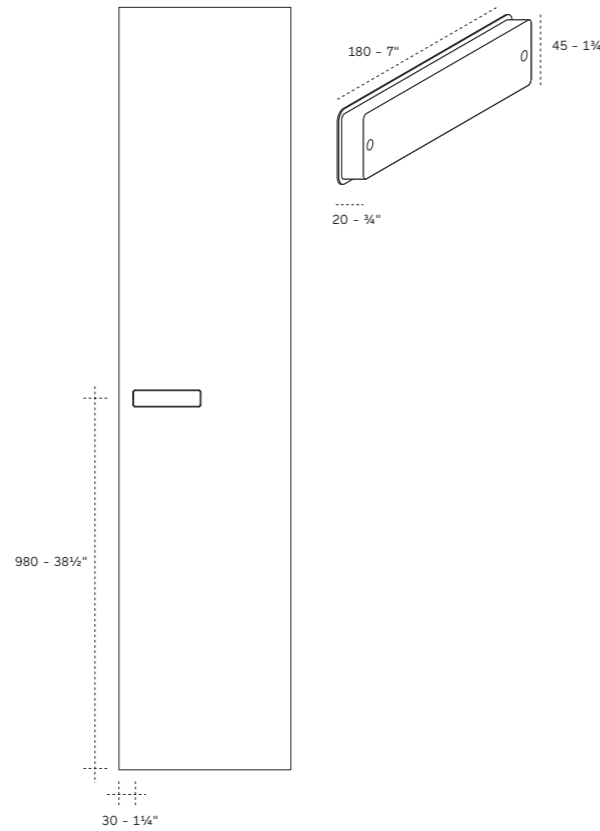

MA10

Finiture
Finishings
 Rovere carbone
 Rovere termotrattato
 Laccato opaco LCT

Oak carbone
 Oak heat-treated
 Lacquered LCT

Orientamento
Positioning
 Verticale - Orizzontale
 Vertical - Horizontal

Ante
Doors
 Prima
 (battente - hinged)

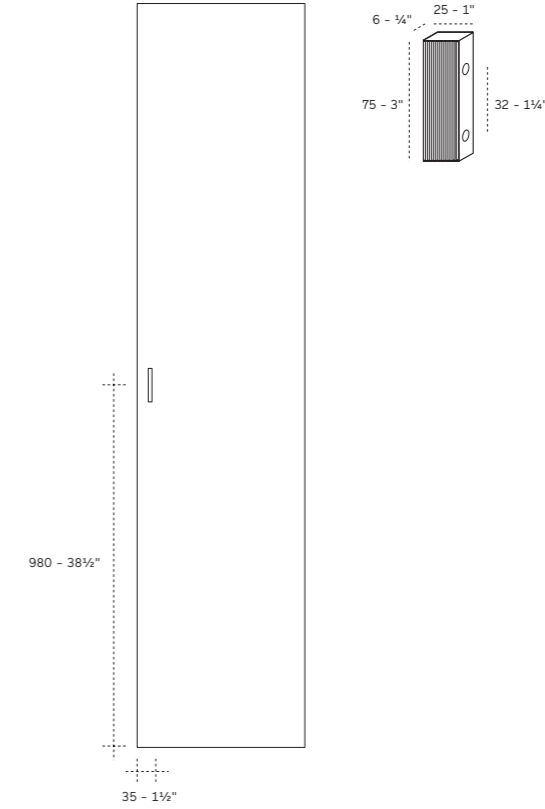

MT40

Finiture
Finishings
 Metallo verniciato:
 bronzo patinato M422
 laccato opaco LCT

Metal painted:
 coated bronze M422
 matt lacquered LCT

Ante
Doors
 Prima
 (battente - hinged)

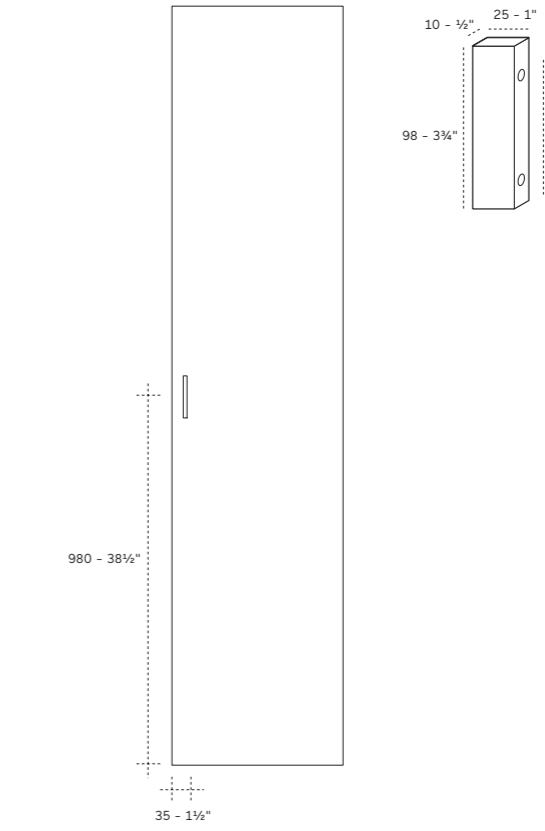

Maniglie — Handles

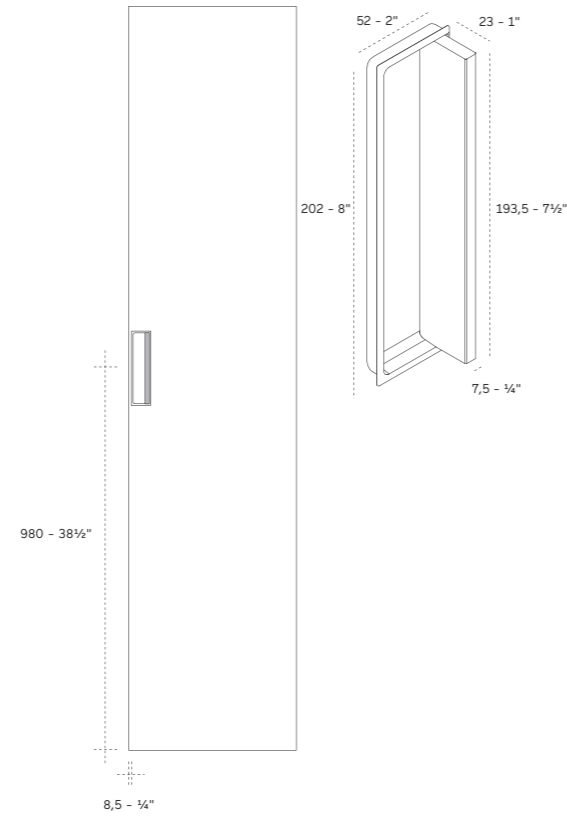

MA46

**Finiture
Finishings**
Metallo verniciato:
bronzo epox M421
laccato opaco LCT

Metal painted:
bronze epox M421
matt lacquered LCT

**Ante
Doors**
Prima
(battente - hinged)

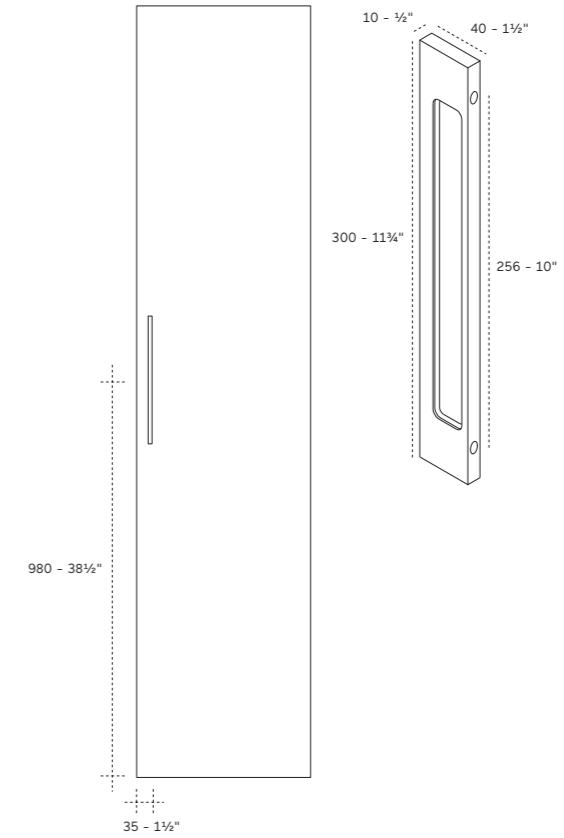

MA45

**Finiture
Finishings**
Metallo verniciato:
bronzo epox M421
laccato opaco LCT

Metal painted:
bronze epox M421
matt lacquered LCT

**Ante
Doors**
Prima
(battente - hinged)

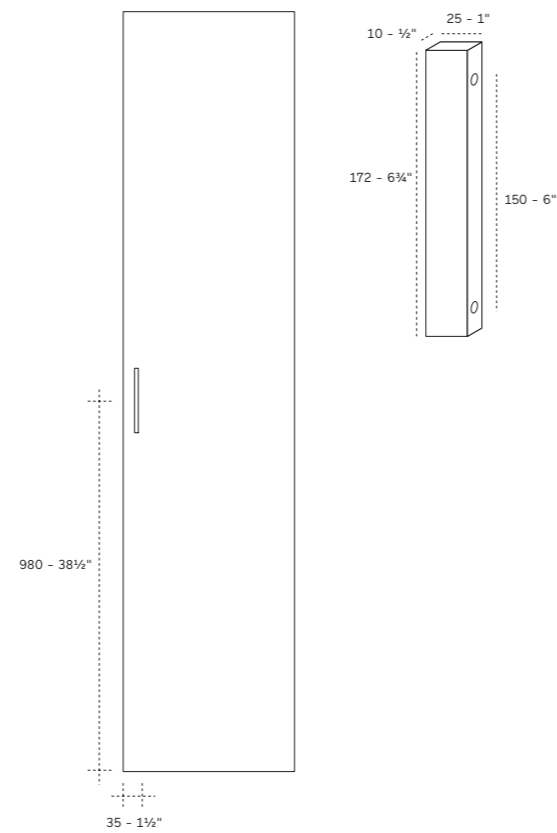

MA02

**Finiture
Finishings**
Rovere carbone
Rovere termotrattato
Laccato opaco LCT

Oak carbone
Oak heat-treated
Lacquered LCT

**Orientamento
Positioning**
Verticale - Orizzontale
Vertical - Horizontal

**Ante
Doors**
Prima
(battente - hinged)

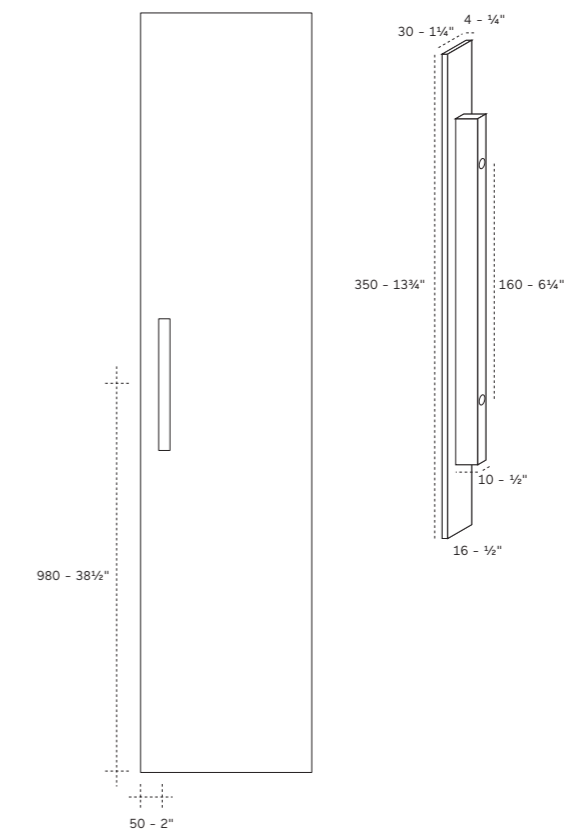

MA92

**Finiture
Finishings**
Metallo verniciato:
bianco M410 (RAL 9016)
bronzo epox M421
laccato opaco LCT

Metal painted:
white M410 (RAL 9016)
bronze epox M421
matt lacquered LCT

**Ante
Doors**
Prima
(battente e complanare -
hinged and coplanar)

Maniglie — Handles

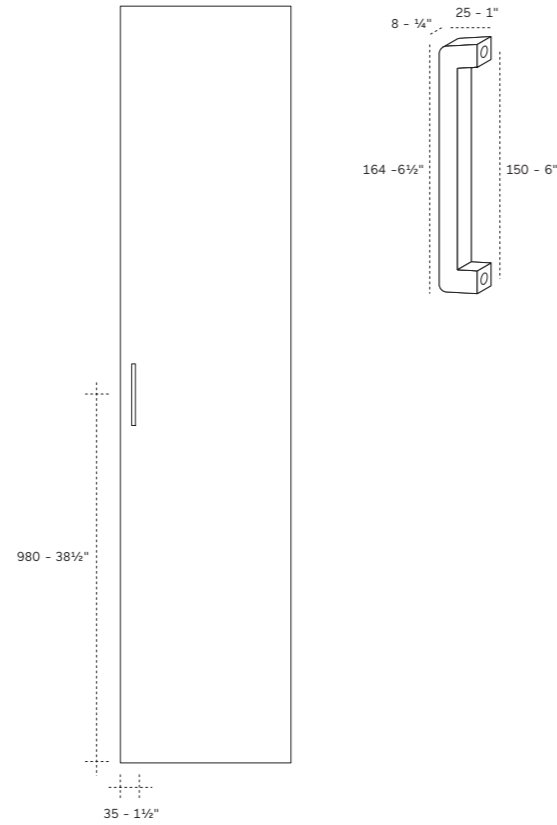

MA01

**Finiture
Finishings**
Metallo verniciato
alluminio M405

Metal aluminium
painted M405

**Orientamento
Positioning**
Verticale - Orizzontale
Vertical - Horizontal

Vertical
Horizontal

**Ante
Doors**
Prima
(battente - hinged)

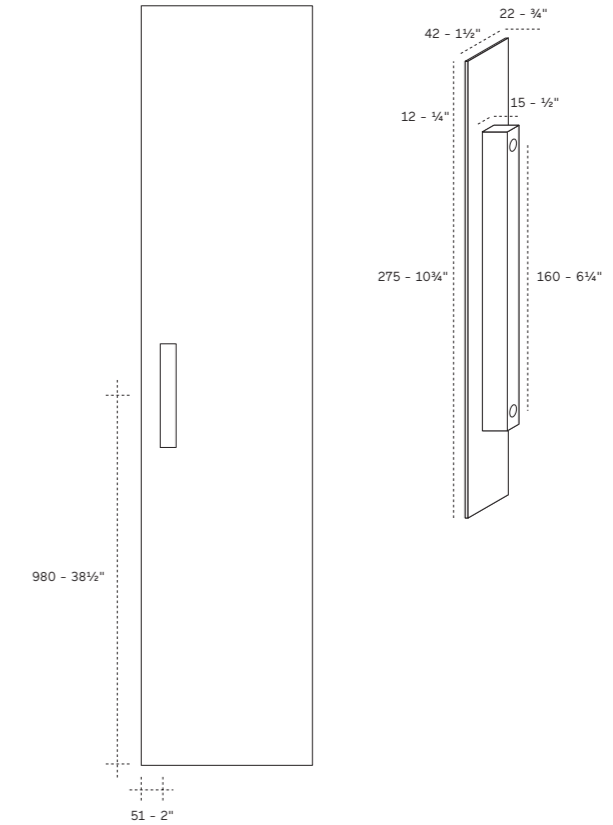

MA58

**Finiture
Finishings**
Rivestimento cuoio light:
Bianco C04
Naturale invecchiato C26
Prugna C15
Nero C02

Light hide coverings:
Bianco C04
Naturale invecchiato C26
Prugna C15
Nero C02

**Ante
Doors**
Prima
(battente - hinged)

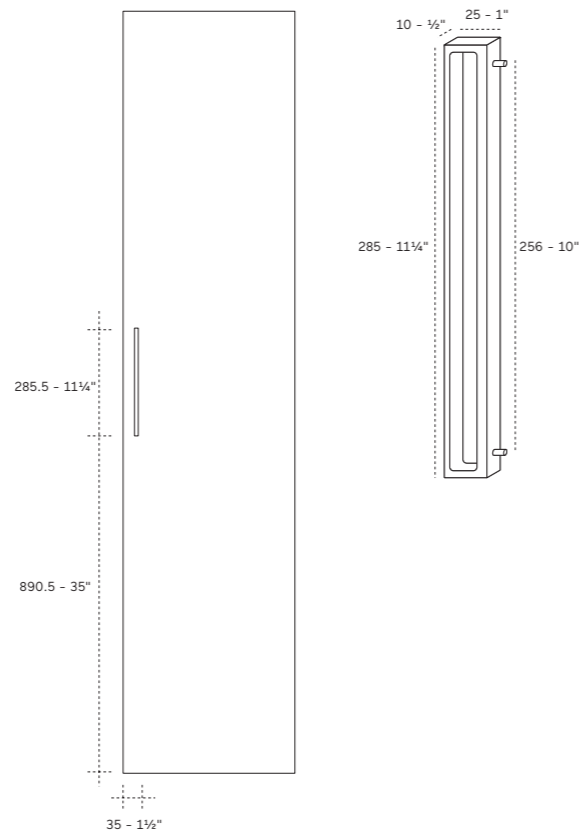

MA25

**Finiture
Finishings**
Metallo verniciato
alluminio M405

Metal aluminium
painted M405

**Orientamento
Positioning**
Verticale - Orizzontale
Vertical - Horizontal

Vertical
Horizontal

**Ante
Doors**
Prima
(battente - hinged)

Maniglie — Handles

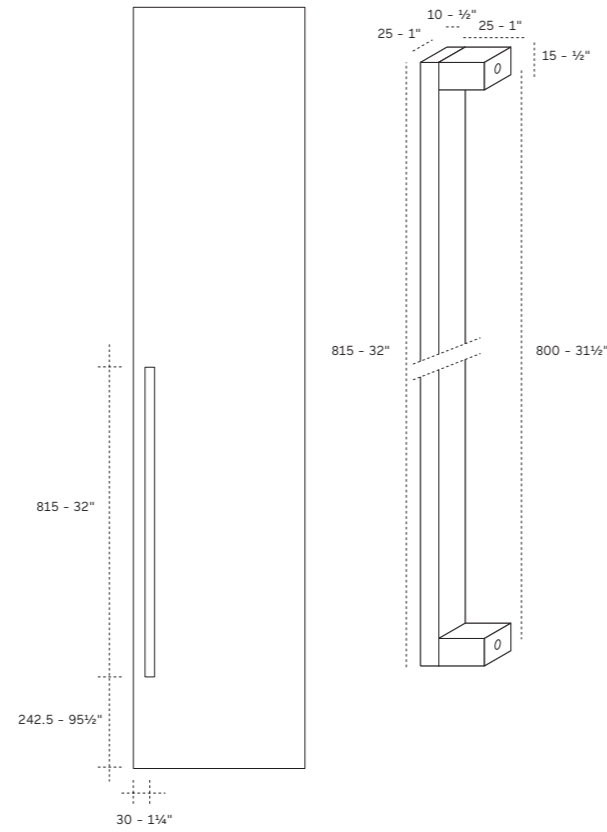

MA81

**Finiture
Finishings**
Metallo verniciato
alluminio M405

Metal aluminium painted
M405

**Ante
Doors**
Prima
(battente - hinged)

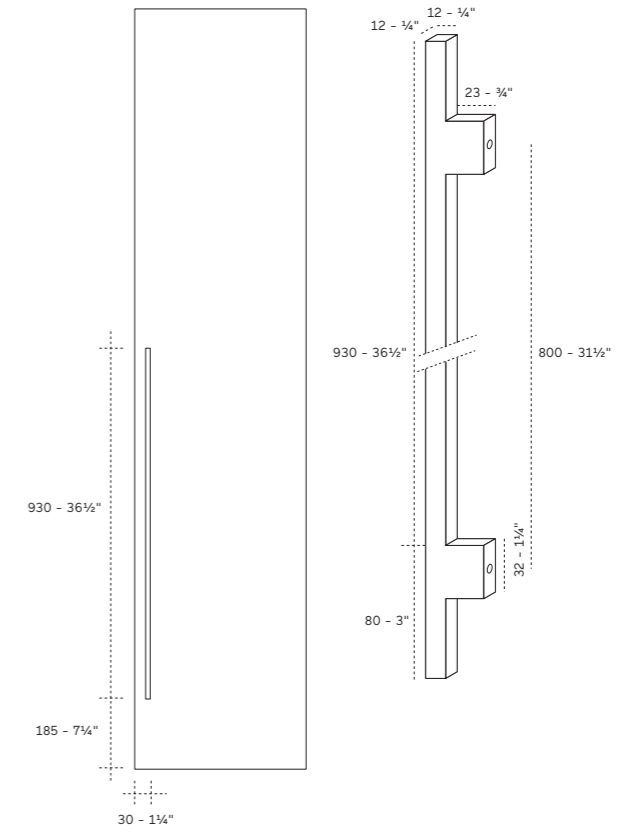

MA53

**Finiture
Finishings**
Metallo cromato M200
Metallo verniciato bronzo
M421

Metal chromed M200
Metal bronze painted
M421

**Ante
Doors**
Prima
(battente - hinged)

Serratura anta Dandy — Lock for Dandy door

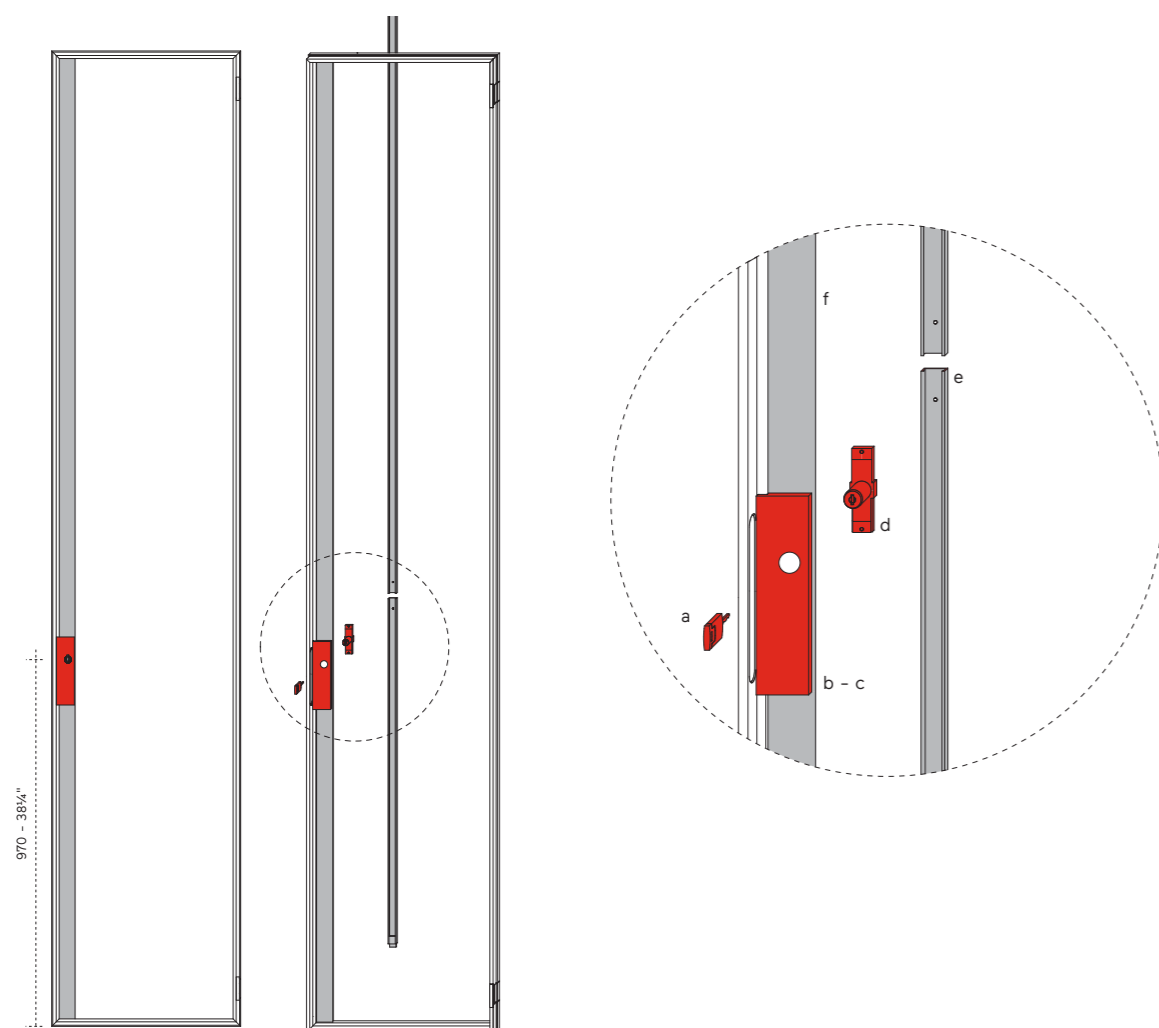

Descrizione componenti Component description

- a. Chiave
- b.-c. Piastra alluminio anteriore/posteriore
- d. Serratura
- e. Cariglione
- f. Fascia retrolaccata*

- a. Key
- b.-c. Front/rear aluminium plate
- d. Lock
- e. Lever bolt
- f. Back-lacquered band*

Finiture - Finishing

Piastra Plate

Metallo verniciato:
bronzo epox M421
sand epox M455

Metal painted:
bronze epox M421
sand epox M455

Chiave, serratura, cariglione Key, lock, lever bolt

verniciato color:
nero - telaio bronzo
epox M421
argento - telaio sand
epox M455

painted: black - frame
bronze epox M421
silver - frame sand epox
M455

Fascia retrolaccata* Back-lacquered band*

vernice color:
bronzo M421
sand M455
nero

paint colour:
bronze M421
sand M455
black

Informazioni utili Useful information

Disponibile per anta Dandy con:
vetro trasparente
vetro fumè grigio
vetro bronzo riflettente
vetro bronzo serigrafato
vetro retrolaccato

Available for Dandy door with:
transparent glass
grey smoked reflecting glass
bronze serigraphed glass
back-lacquered bronze glass

*

In presenza di vetro bronzo riflettente la fascia retrolaccata sarà verniciata color nero.
In presenza di vetro fumè grigio la fascia retrolaccata sarà sempre verniciata bronzo epox M421

In the presence of reflecting bronze glass, the back-lacquered band will be painted black.
In the presence of grey smoked glass, the back-lacquered band will be painted bronze epox M421



Finiture ante — Doors finishings

Le essenze legnose, il massello, le argille, sono materiali che Lema utilizza per le ante, fianchi esterni e zoccoli degli armadi e che tratta con la sapiente cura della più antica tradizione. Nel legno possiamo trovare differenze nella venatura, nelle argille, particelle di terra cruda, stese mediante un processo di spatolatura e successivamente protette da una verniciatura acrilica e da una verniciatura nanomolecolare trasparente, la differenza di tonalità e il viraggio incontrollato di colore sono il punto di forza del prodotto stesso. I pigmenti utilizzati per le laccature sono a base organica e dotati di elevata stabilità alla luce.

Lema uses traditional expertise to process wood, solid wood and clay for the doors, external sides and plinths of its wardrobes. Wood offers infinite variations of veining, while the clays – particles of unfired earth – are stretched through a brushing process before being protected by layers of acrylic paint and transparent nanomolecular paint. These different hues and the spontaneous colour changes are the strengths of the product. The pigments used for lacquering are organic-based and have a high stability to light.



Lemacolortrend LCT



Mango 845 Terracotta 478 Amarena 828 Bruciato 477



Cameo 930 Biscotto 932 India 936 Curry 922



Pistacchio 928 Salvia 835 Timo 480 Avio 476



Lauro 924 Assenzio 479 Ottano 847 Cobalto 926



Oltremare 469 Lavagna 713 Fumo 906 Grafite 918



Fango 471 Basalto 920 Antimonio 870 Ghiaia 913

Lemacolortrend LCT



Cigno 700 Carta 750 Latte 405 Canapa 707



Calcare 801 Sabbia 910 Ombra 803 Pepe 804



Cacao 461 Terra 805 Moro 934

Argille — Clay



Ardesia G116 Creta G101 Polvere G111 Sabbia G106



Pece G126

Lemacolorlucido LCL

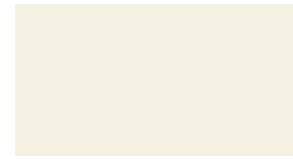

Paper 227
LCT Carta 750 •

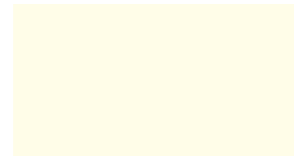

Bianco 200
LCT Latte 405 •



Scoglio 212
LCT Sabbia 910 •



Nocciola 213
LCT Ombra 803 •



Seta 244
LCT Cameo 930 •



Caramello 245
LCT Biscotto 932 •



Agave 243
LCT Pistacchio 928 •



Ortica 235
LCT Salvia 835 •



Aneto 232
LCT Timo 480 •



Persia 241
LCT Avio 476 •



Ruta 231
LCT Assenzio 479 •



Alloro 240
LCT Lauro 924 •



Oro 247
LCT India 936 •



Miele 239
LCT Curry 922 •



Ciliegia 216
LCT Amarena 828 •



Granata 238
LCT Bruciato 477 •



Marna 237
LCT Basalto 920 •



Talpa 233
LCT Terra 805 •



Danubio 242
LCT Cobalto 926 •



Grigio 205
LCT Fumo 906 •



Alga 222
LCT Fango 471 •

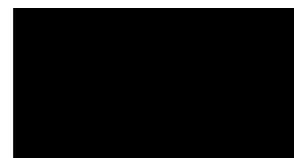

Nero 215
LCT Lavagna 713 •

Corrispondenza in LCT •
Correspondence in LCT •

Melaminici Struttura e Attrezzatura — Structure and Equipment Melamine



Canvas



Lino



Visone



Larice moka - Moka larch

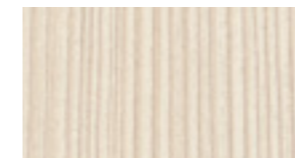

Larice sbiancato - Bleached larch



Larice grigio - Grey larch

Melaminici Ante — Doors Melamine



Canvas



Lino



Visone

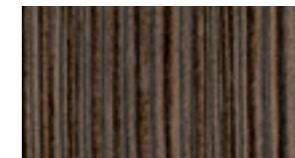

Larice moka - Moka larch

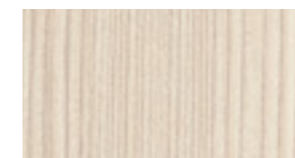

Larice sbiancato - Bleached larch



Gobi



Sahara

Cuoio Light — Light Hide

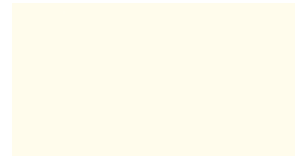

Bianco C04



Avorio C28



Tortora C29



Naturale C26



Grigio C03

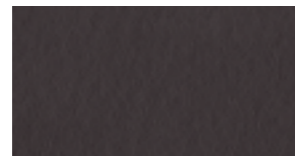

Caffè C19

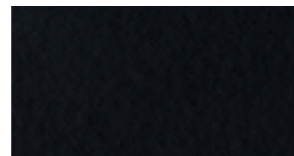

Nero C02



Prugna C15

Essenze — Woods



Rovere carbone - Carbone oak



Rovere termotrattato
Heat-treated oak



Noce-L - L-walnut



Noce canaletto dogato
Slatted canaletto walnut

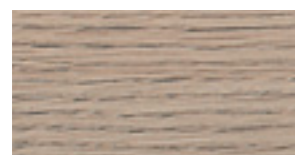

Rovere grigio - Grey oak

Rivestimenti Decorativi Tessili — Textile Decorative Covering (solo per fondali e anta Dandy — only for back panels and Dandy door)



Elide 220



Elide 221



Elide 222



Elide 223

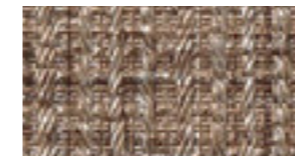

Argo 210



Argo 211



Argo 212



Argo 213

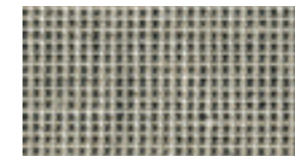

Antea 300

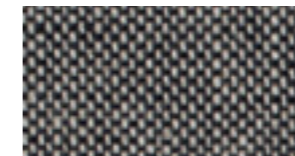

Antea 304

Metalli — Metals

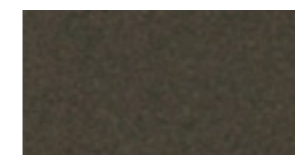

Verniciato bronzo epox M421
Bronze epox painted M421



Verniciato sand epox M455
Sand epox painted M455



Anodizzato warm M103
Anodised warm M103



Verniciato bronzo M420
Bronze painted M420

Vetro laccato — Laquered glass

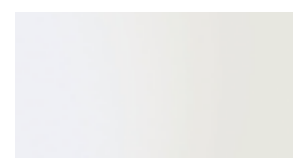

Bianco V10

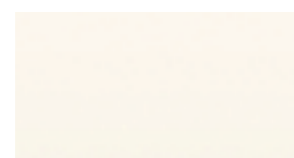

Yogurt V100



Perla V105



Avorio V30



Titanio V110



Tortora V115



Grigio V60



Nero V20



Aragosta V120



Rosso V125

Vetri Speciali — Special Glass

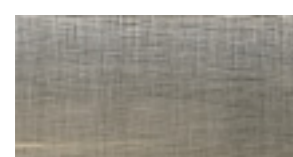

Bronzo serigrafia tessuto
Bronze with fabric serigraphy



Specchio - Mirror

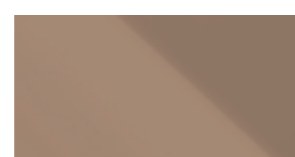

Specchio bronzo - Bronze mirror

Vetri Trasparenti — Transparent Glass



Trasparente
Transparent



Bronzo riflettente
Reflecting bronze



Fumè grigio
Grey smoke

Vetri Acidati Rerolaccati, Back — Laquered Frosted Glass



Ematite V260 (opaco/matt) *

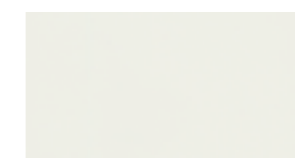

Talco V210 (opaco/matt) *



Giada V240 (opaco/matt) *

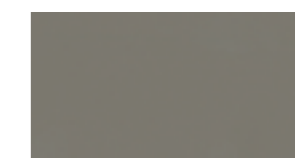

Iridio V250 (opaco/matt) *

* Solo per anta Emery, Solely for Emery door

3.

OPEN WARDROBE

Modularità e personalizzazione sono le parole chiave. Un armadio aperto collocabile in una stanza dedicata, versatile, che offre libertà progettuale e personalizzazione.

Il programma si sviluppa intorno ai moduli base dell'Armadio al Centimetro, adattabili in altezza, larghezza e profondità.

Ricca è anche l'offerta di attrezzature interne che spaziano da cassettiere a portapantaloni a portabiancheria e portascarpe estraibili; dalla mensola con luce integrata al fianco luminoso, al fondale in rivestimento decorativo tessile. Così, senza vincoli progettuali, l'armadio Open si trasforma in infiniti armadi, ciascuno con un gusto e una personale ricercatezza.

Modularity and customization are the key words. An open wardrobe that can be placed in a dedicated space, its versatility offering complete freedom in design and customization. The system is developed around the base modules of the Armadio al Centimetro, whose height, width and depth can be modified. There is also an ample range of interior equipment, including drawers, trouser-hangers, linen racks and pull-out shoe-racks, along with shelves with built-in lighting, illuminated side-panels and back panels lined with decorative fabric. With no restraints on design, the Open wardrobe becomes an endless series of wardrobes, each with its refined and personal taste.



Componenti — Components

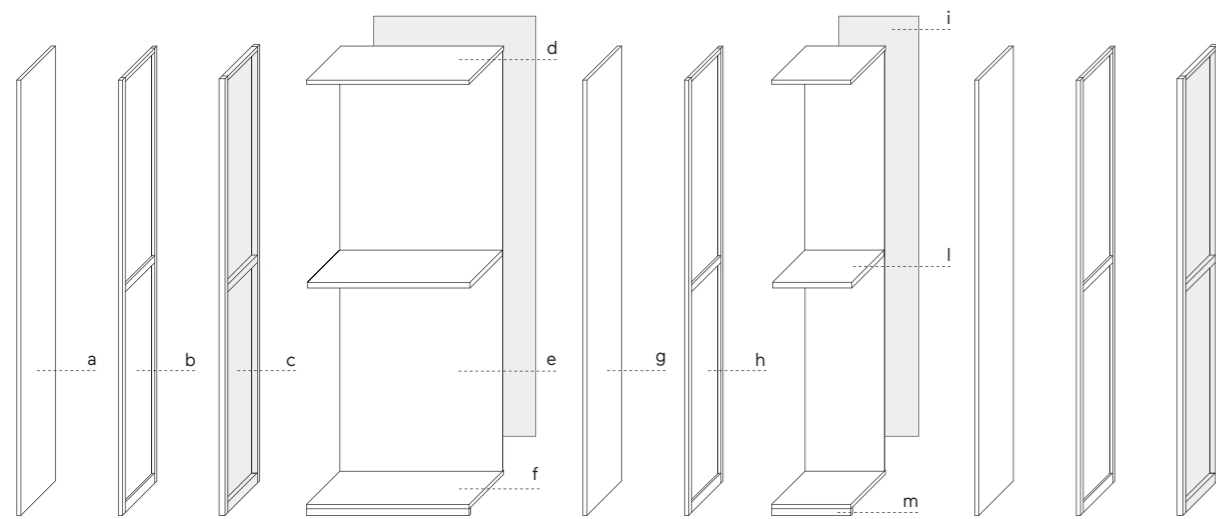

Componenti struttura Structure components

a. Fianco esterno	a. External side
b. Fianco esterno telaio	b. External frame side
c. Fianco esterno vetro	c. External side in glass
d. Coperchio	d. Top
e. Fondale	e. Back panel
f. Base	f. Base
g. Fianco interno	g. Internal side
h. Fianco interno telaio	h. Internal frame side
i. Fondale in vetro	i. Glass back panel
l. Ripiano	l. Shelf
m. Zoccolo	m. Plinth

Nota Note

Tutti i componenti dell'armadio Open sono i medesimi dell'Armadio al Centimetro. Pag. 14-15

E' possibile inserire le attrezzature descritte da pag. 166 a pag. 249 per realizzare tutte le combinazioni desiderate

All the components of the Open wardrobe are the same as those of the Armadio al Centimetro. Pages 14-15

It is possible to insert the equipment described from page 166 to page 249 to realize all the desired combinations

Struttura — Structure

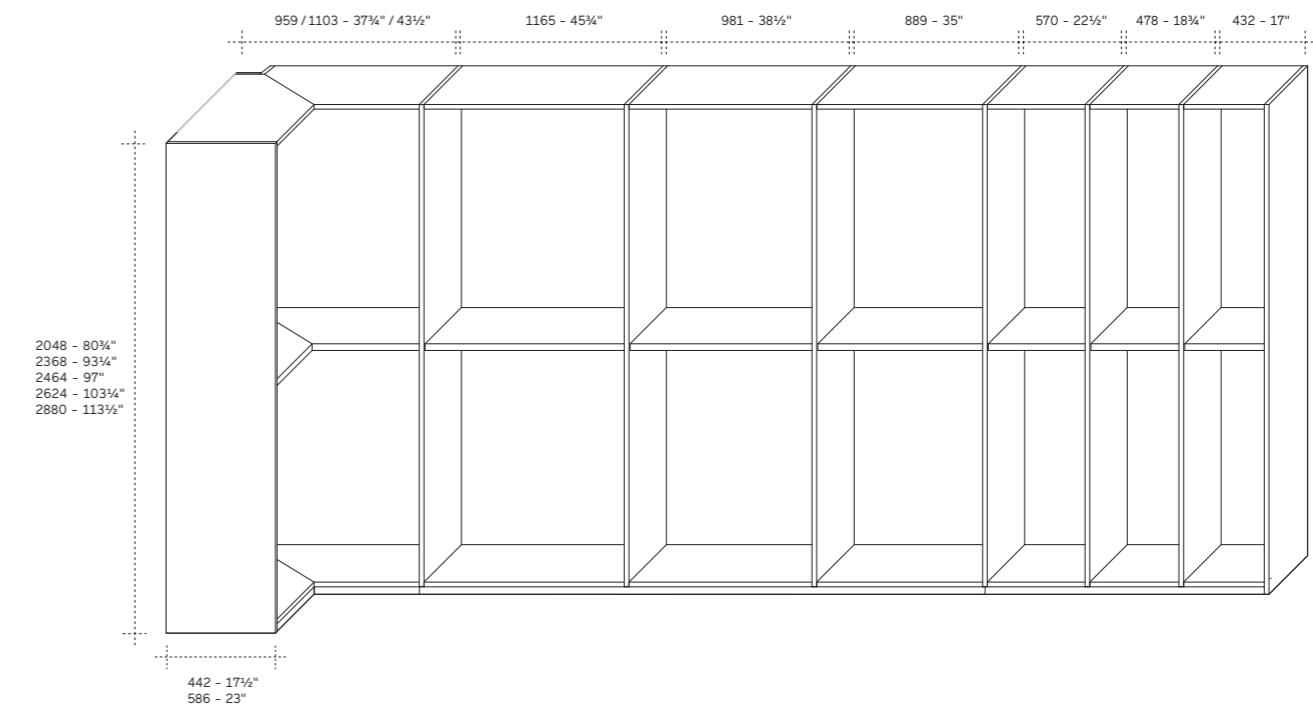

Dimensioni Dimensions

6 larghezze 6 widths

432 - 478 - 570 - 889 - 981 - 1165
17" - 18¾" - 22½" - 35" - 38½" - 45¾"

5 altezze 5 heights

2048 - 2368 - 2464 - 2624 - 2880
80¾" - 93¾" - 97" - 103¾" - 113½"

2 profondità 2 depth

Fianco 442 - 586
Side 17½" - 23"

Spazio per montaggio di serie Space for standard installation

In altezza mm.10 in più dell'altezza del fianco dell'armadio. In larghezza mm. 50 in più della larghezza dell'armadio. Su richiesta viene inserita la ferramenta speciale per il montaggio in nicchia

¼" higher than the wardrobe 2" wider than the wardrobe. On request, special hardware can be inserted for assembly in a recess

Spazio per montaggio in nicchia Space for installation in a recess

In altezza mm.10 in più dell'altezza del fianco dell'armadio. In larghezza mm.15 in più della larghezza dell'armadio

½" higher than the side panel of wardrobe. ½" wider than the wardrobe

Spazio per montaggio in presenza di illuminazione Space for installation with led light

In presenza di illuminazione, con o senza contenitore per cablaggi, considerare per il montaggio 50 mm. in più dell'altezza del fianco dell'armadio

If there is lighting, with or without a cable holder, it is necessary 2" more than the height of the side panel of the wardrobe

4.

TIAN WARDROBE

Tian, dal cinese cielo, è l'armadio a tutto vetro di Lema. È un'isola trasparente, una finestra che si affaccia sugli spazi della casa e vi si specchia. Un armadio concepito come una vetrina effetto acquario, pensato anche a centro stanza che unisce, disimpegna, divide, illumina. Uno scrigno dove i segreti si frantumano e diventano essi stessi espressione formale e visiva del prodotto.

La forza espressiva di Tian risiede nel perfetto allineamento del vetro a filo con i montanti metallici: un plus tecnologico dal forte impatto estetico, che dona all'armadio un'immagine monolitica e pura, dove la superficie in vetro diventa uno skydome senza interruzioni. Qui, nella versione in vetro bronzo riflettente con profili in metallo verniciato bronzo.

Tian, from the Chinese word for sky, is an all-glass wardrobe by Lema. It is a transparent island, a window that overlooks the spaces of the home and mirrors them. A wardrobe conceived as showcase with an aquarium effect, that illuminates and unites or divides when positioned in the centre of the room. A treasure chest where secrets are shattered and they themselves become the formal and visual expression of the product.

The expressive strength of Tian lies in the perfect alignment of the flush glass with metal mounts: a technological advantage with a strong aesthetic impact that gives the wardrobe a monolithic and pure image, where the glass surface becomes a kind of continuous skydome, without interruption. Here, in the reflecting bronze glass version with profiles in metal painted bronze.



Componenti — Components

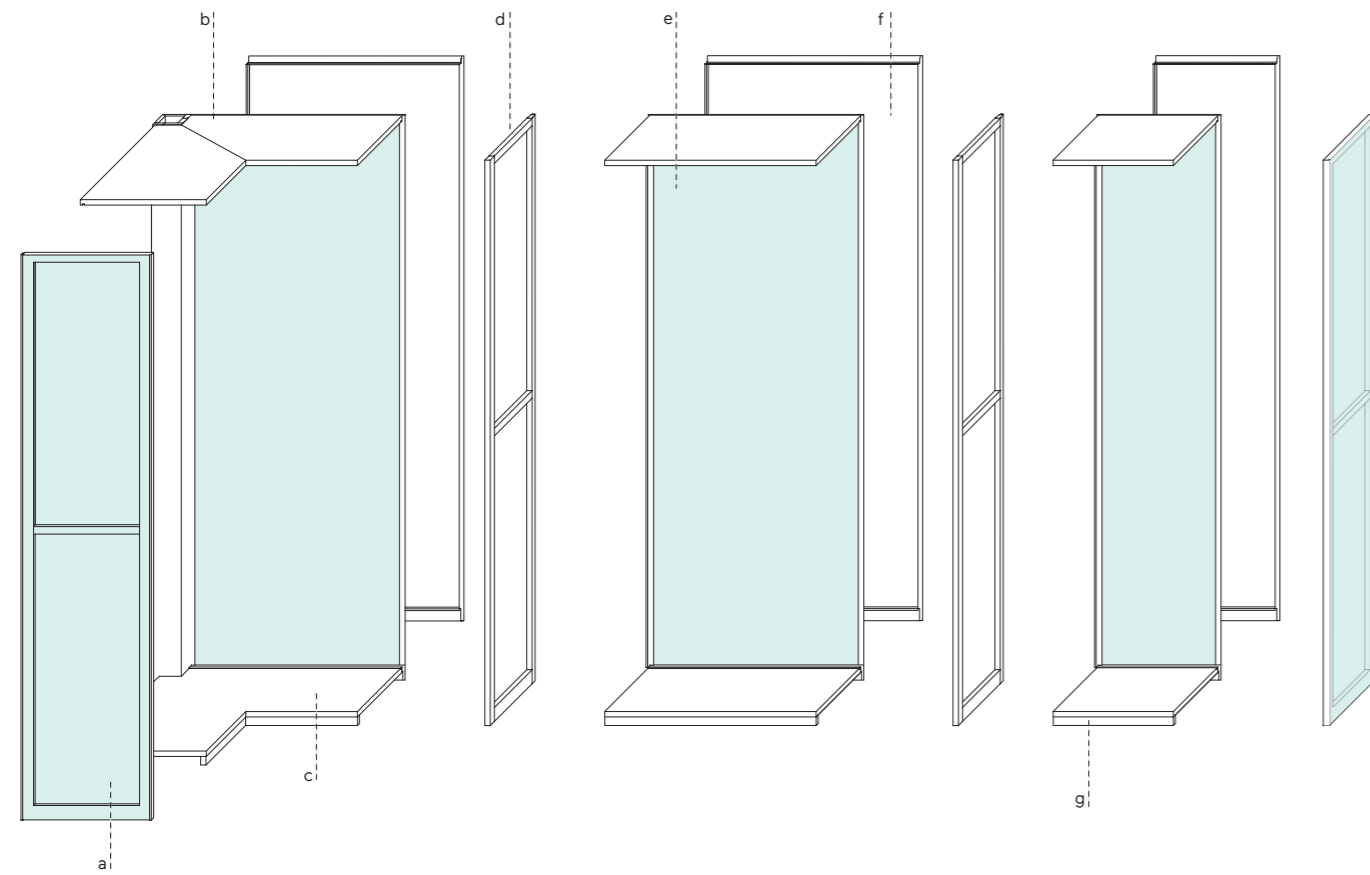

Componenti struttura Structure components

- a. Fianco esterno Tian
- b. Coperchio
- c. Base
- d. Fianco interno Tian
- e. Fondale vetro Tian
- f. Fondale melaminico Tian
- g. Zoccolo

- a. Tian external side
- b. Top
- c. Base
- d. Tian internal side
- e. Tian glass back panel
- f. Tian melamine back panel
- g. Plinth

Dimensioni Dimensions

6 larghezze 6 widths

432 - 478 - 570 - 889 -
981 - 1165
17" - 18¾" - 22½" -
35" - 38½" - 45¾"

4 altezze 4 heights

2368 - 2464 - 2624 -
2880
80¾" - 93¾" - 97" -
103¾" - 113½"

1 profondità 1 depth

Fianco 605
Side panel 23¾"

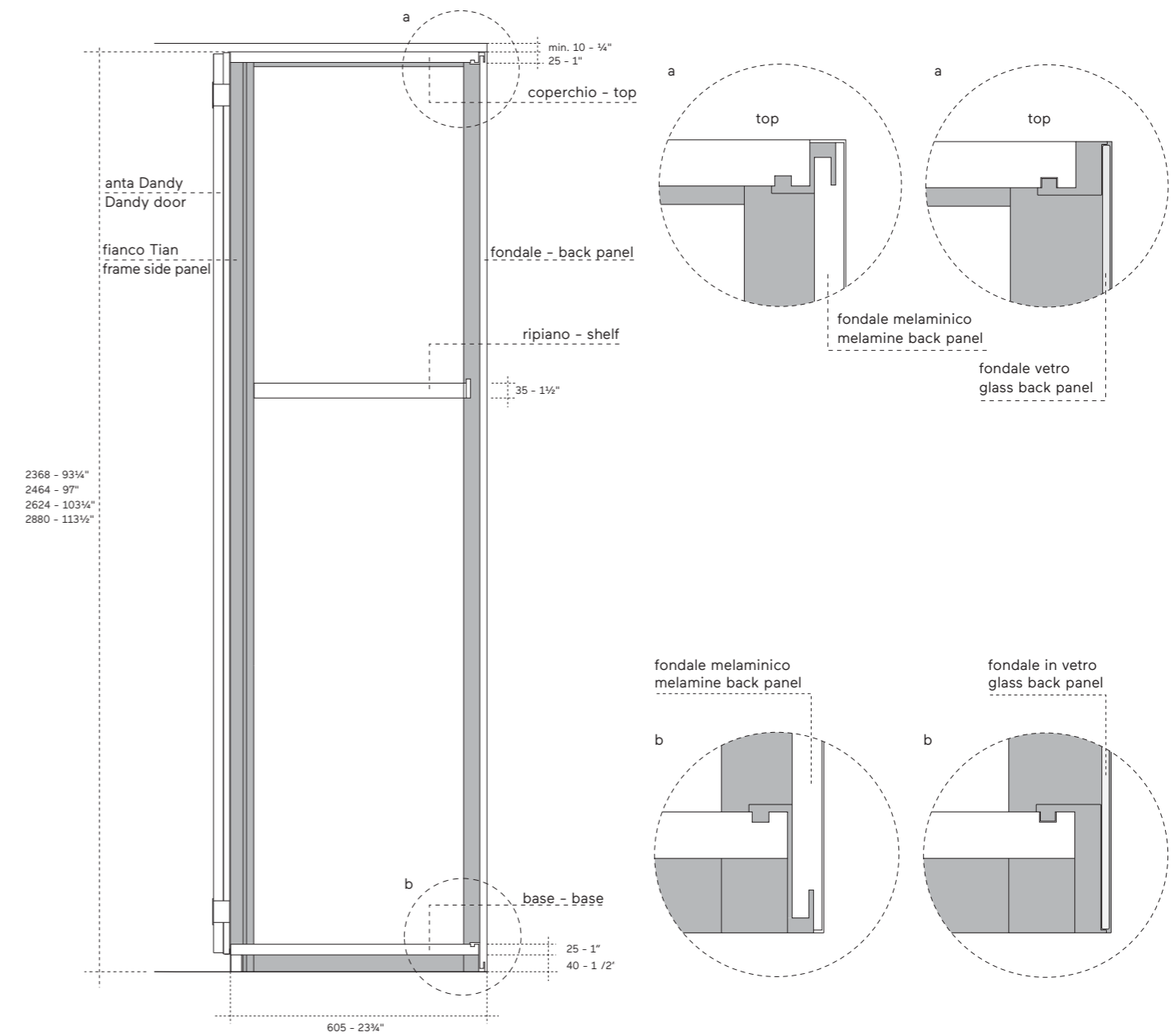

Spazio per montaggio di serie Space for standard installation

In altezza mm. 10 in più dell'altezza del fianco dell'armadio.
In larghezza mm. 50 in più della larghezza dell'armadio.

Su richiesta viene inserita la ferramenta speciale per il montaggio in nicchia

In order to assemble the hinged doors wardrobe, it is necessary to add 2" more than the width of the wardrobe and ¾" more than the height of the side panel

Spazio per montaggio in nicchia Space for installation in a recess

In altezza mm. 10 in più dell'altezza del fianco dell'armadio.
In larghezza mm. 15 in più della larghezza dell'armadio

For the niche assembly, it is necessary to add 1/2" more than the width of the wardrobe and 1/2" more than the height of the side panel

Spazio per montaggio in presenza di illuminazione Space for installation with led light

In presenza di illuminazione, con o senza contenitore per cablaggi, considerare per il montaggio 50 mm. in più dell'altezza del fianco dell'armadio

Where lighting is present, with or without a cable box, 2" more than the height of the side panel of the wardrobe is required

Componibilità — Layouts

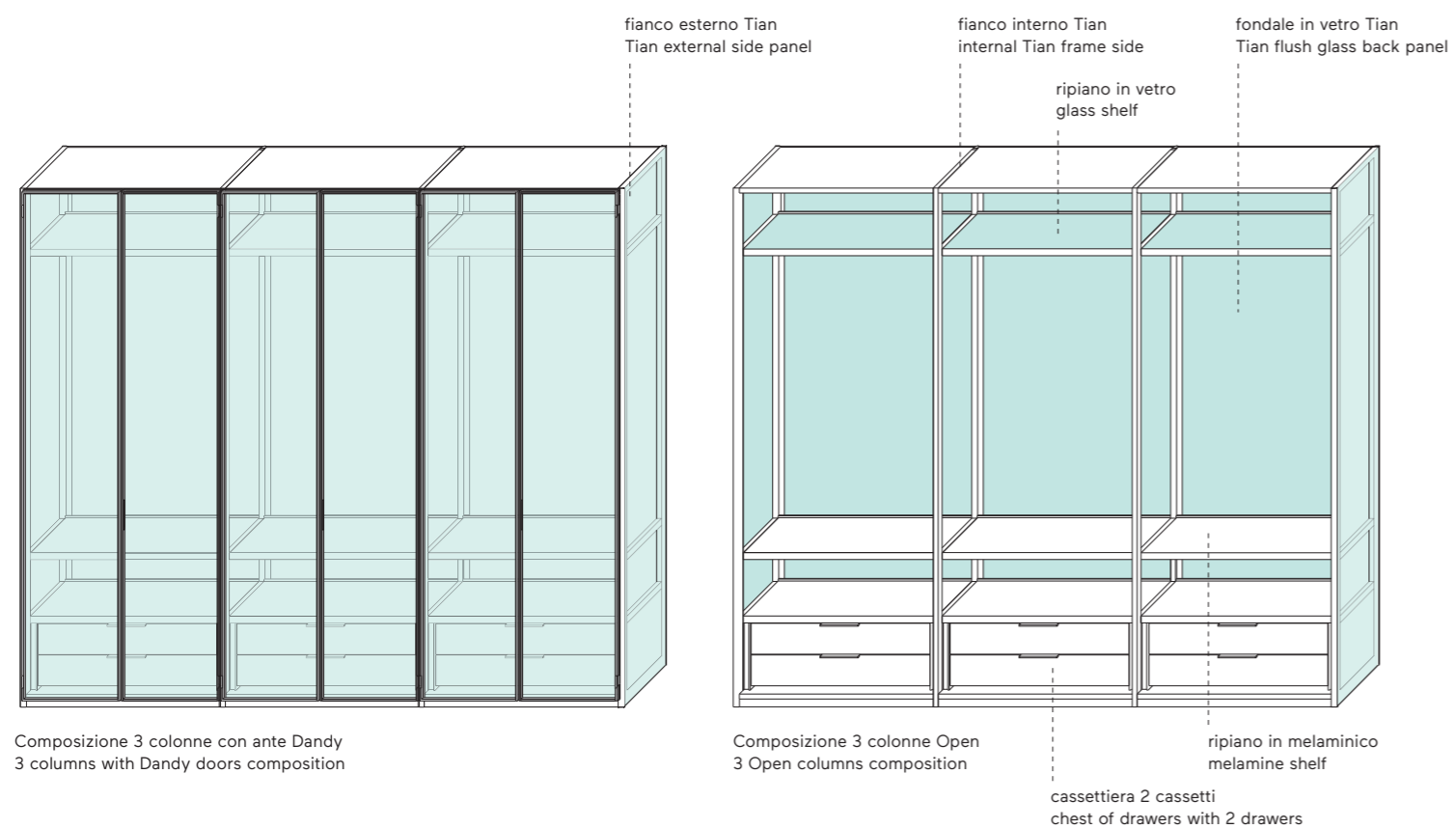

Descrizione

Description

Sistema Tian disponibile con ante Dandy o soluzione Open senza ante

Tian system available with Dandy doors or Open without doors solution



Fianchi, angolare e fondali

Sides, corners and back panels

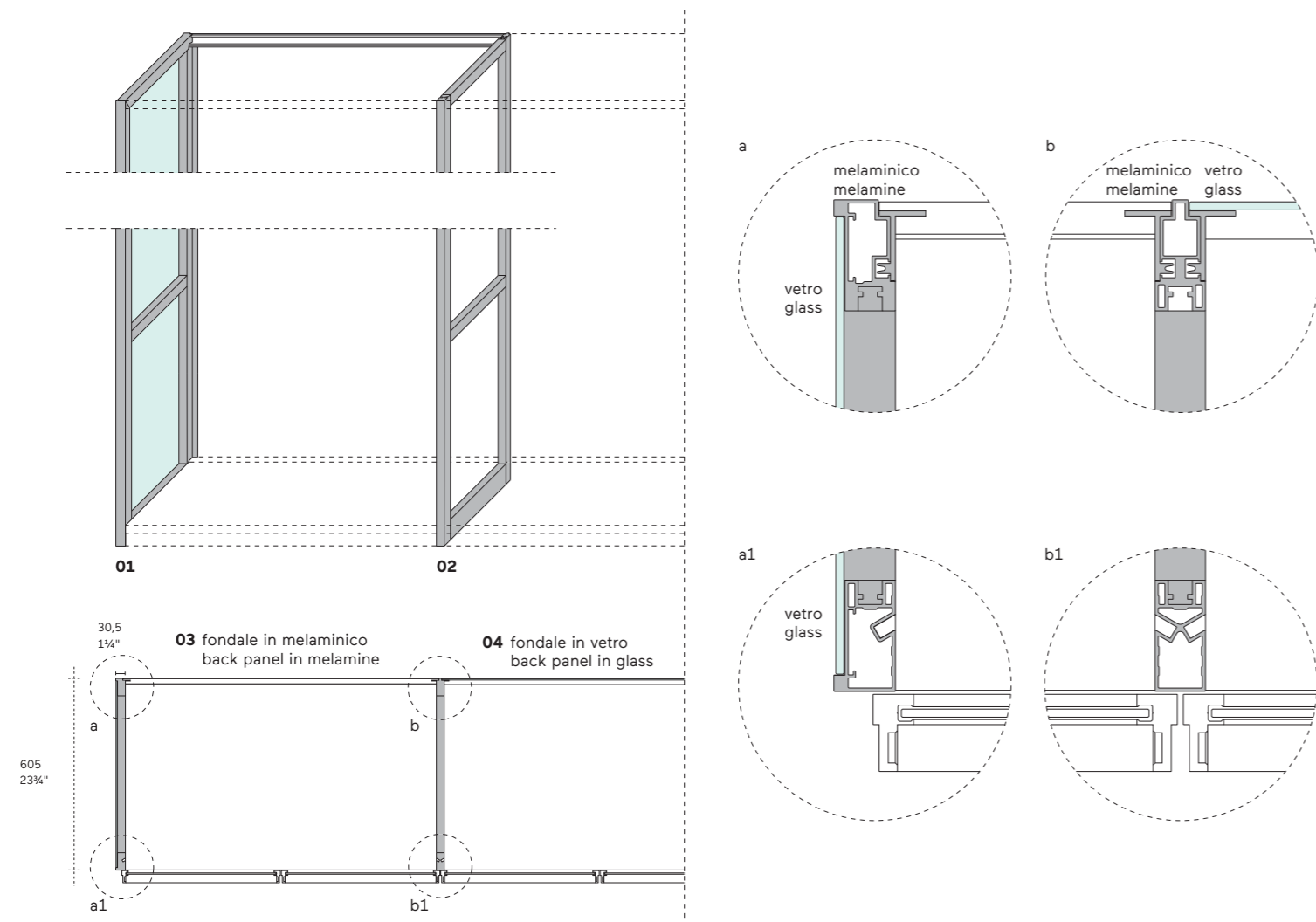

01	02	03	04	a - a1 - b - b1	
Fianco esterno Tian Tian external side	Fianco interno Tian Tian internal side	Fondale in vetro Tian Tian glass back panel	Fondale in melaminico Tian Tian melamine back panel	a Sezione orizzontale posteriore fianco esterno Tian	a1 Sezione orizzontale anteriore fianco interno Tian
Composto da almeno 1 trasverso. Composed with at least no.1 traverse	Composto da almeno 1 trasverso. Composed with at least no.1 traverse	Fondale montato a filo struttura Back panel installed in line with structure	Fondale montato a filo struttura Back panel installed in line with structure	Tian horizontal external side rear section	Tian horizontal internal side front section
Spessore Thickness 30,5 - 1¼"	Spessore Thickness 25 - 1"	Spessore Thickness 4 - ¼"	Spessore Thickness 16 - ¾"	a1 Sezione orizzontale anteriore fianco esterno Tian	Tian horizontal side front section
Altezza Height 2368 - 2464 - 2624 - 2880 93¾" - 97" - 103¾" - 113½"	Altezza Height 2368 - 2464 - 2624 - 2880 93¾" - 97" - 103¾" - 113½"	Larghezza Width 448 - 494 - 586 - 905 - 997 - 1181 17¾" - 19½" - 23" - 35¾" - 39¾" - 46½"	Larghezza Width 448 - 494 - 586 - 905 - 997 - 1181 17¾" - 19½" - 23" - 35¾" - 39¾" - 46½"	b Sezione orizzontale posteriore fianco interno Tian	Tian horizontal back side section
Profondità Depth 605 - 23¾"	Profondità Depth 605 - 23¾"	Altezza Height 2366 - 2462 - 2622 - 2878 93¾" - 97" - 103¾" - 113¾"	Altezza Height 2363 - 2459 - 2619 - 2875 93" - 96¾" - 103" - 113¾"		

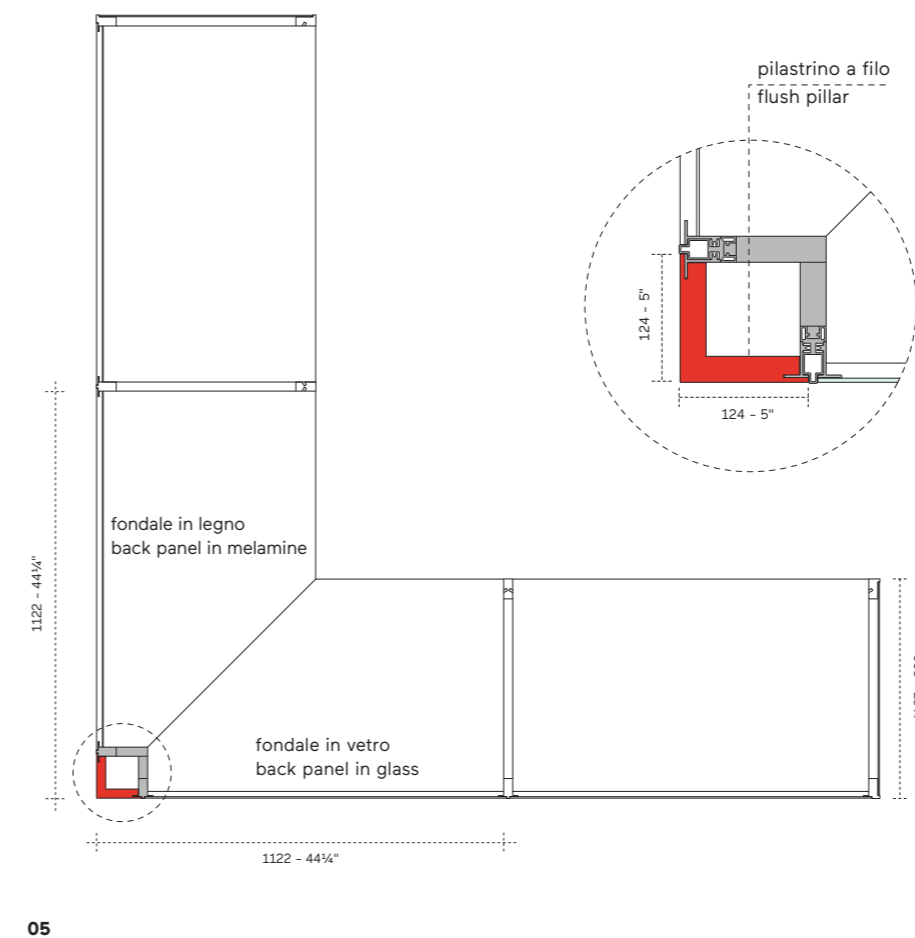

05	Finiture	Finishings
Angolare Tian La soluzione angolare per armadio Tian si completa con l'alloggio di un pilastrino fissato a filo dei fondali della colonna	Telaio: metallo verniciato: bronzo epox M421 sand epox M455	Frame: metal painted: bronze epox M421 sand epox M455
Corner Tian The Tian Wardrobe corner solution also features a pillar positioned in line with the column back panels	Vetro: trasparente fumè grigio bronzo riflettente	Glass: transparent grey smoked reflecting bronze
E' possibile installare le seguenti combinazioni di fondali: vetro + vetro melaminico + melaminico vetro + melaminico	Melaminico: canvas - lino - visone - gobi - sahara - larice sbiancato - larice moka - larice grigio	Melamine: canvas - lino - visone - gobi - sahara - larice sbiancato - larice moka - grey larch
La finitura del pilastrino sarà laccato in abbinamento al metallo dei fianchi telaio presenti nella composizione	The following combinations of back panels can be installed: glass + glass melamine + melamine glass + melamine	The pillar will be lacquered to match the metal used for the frame sides in the composition

Caratteristiche tecniche — Technical Information

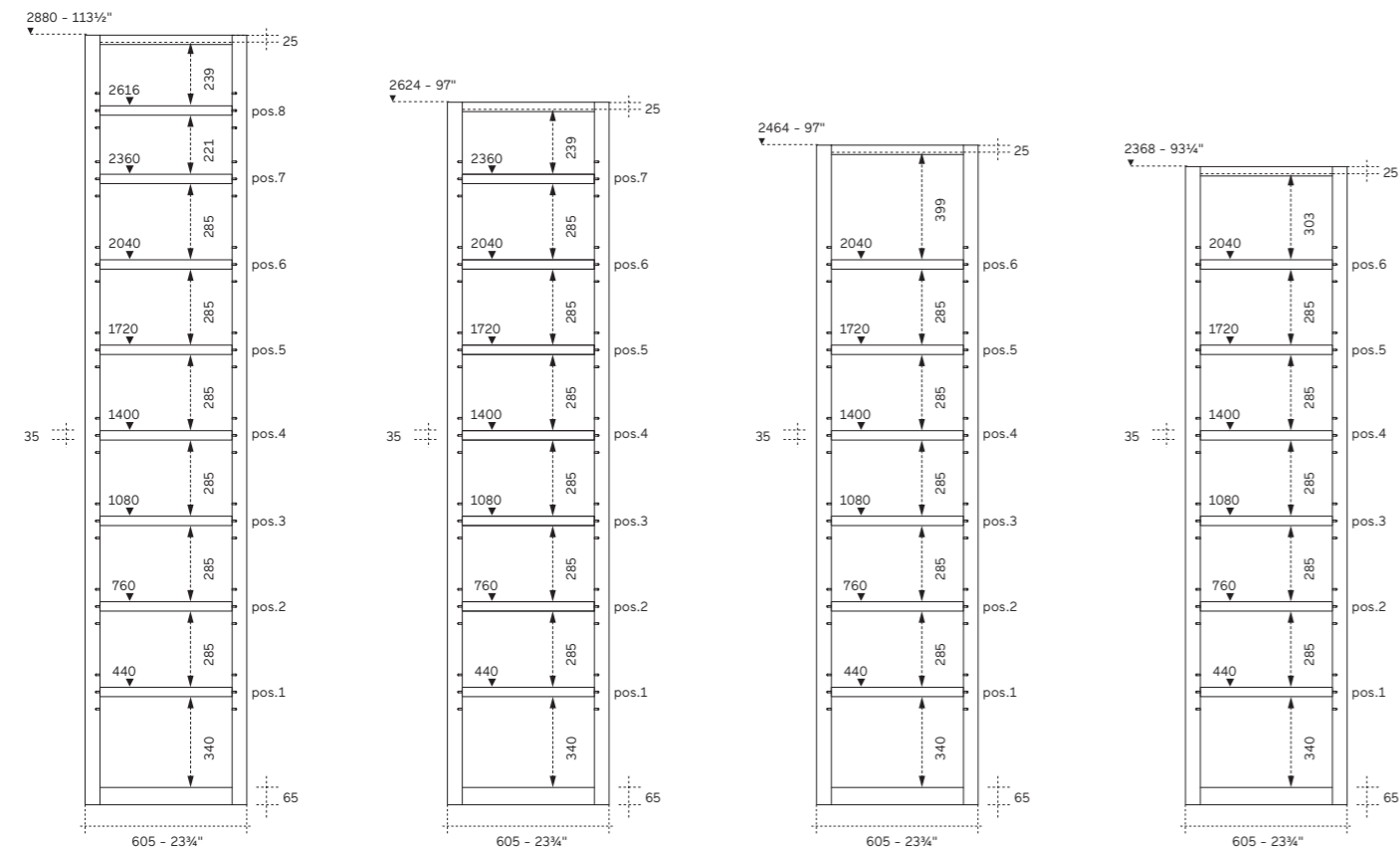

mm. - inches: 25 - 1", 35 - 1 1/2", 65 - 2 1/2", 221 - 8 3/4", 239 - 9 1/2", 285 - 11 1/4", 303 - 12", 399 - 15 3/4", 340 - 13 1/2", 440 - 17 1/4", 760 - 30", 1080 - 42 1/2", 1400 - 55", 1720 - 67 3/4", 2040 - 80 3/4", 2360 - 93", 2616 - 103"

Note generali General note

Ante Doors
Disponibile con Anta Dandy con cerniera apertura 120° su colonne singole e doppie

Available with Dandy door with hinge 120° openings on single and double columns

Colonne ad angolo Corner column
La colonna ad angolo è disponibile con anta Dandy, apertura 180° o soluzione Open senza ante

The corner column is available on Dandy doors, with 180° hinge opening or Open wardrobe without doors

Zoccolo Plinth

In presenza di fianchi Tian, lo zoccolo è installato in luce tra due fianchi. Nelle soluzioni bi-fronte ed in presenza di fondale in vetro, lo zoccolo sul retro, sarà configurato come in facciata

La finitura dello zoccolo sarà laccato in abbinamento al metallo dei fianchi telaio presenti nella composizione

Where Tian sides are present, the plinth is visible between the two sides. In double-faced solutions and solutions where a glass back panel is present, the plinth on the rear will be configured as per the front

The plinth finishing will be lacquered to match the metal used for the frame sides in the composition

Passo di foratura Drilling

Il passo di foratura a 3 fori su fianco telaio è vincolato in specifiche posizioni non personalizzabili

Ogni attrezzatura è riposizionabile a +64 e -64 rispetto alle posizioni predefinite

Vedi disegno "pos. 1 - 2 - 3 - etc."

The drilling pitch with 3 holes on the frame side is restricted to specific positions which cannot be customised

Each equipment can be repositioned at +64 and -64 from the predefined positions

See the drawing "pos. 1 - 2 - 3 - etc."

Riduzioni Reduction

Non sono possibili riduzioni

Ogni richiesta verrà valutata singolarmente dal nostro Ufficio Tecnico considerando una possibile la riduzione solo in altezza

Reductions are not possible

All requests will be individually assessed by our Technical Department, but only height reductions are possible

Nota Note

Su richiesta è possibile installare la cerniera con apertura 180° sulle colonne singole e doppie. In tal caso per consentire l'apertura dei cassetti sarà necessario aprire l'anta alla massima rotazione

By request, the 180° opening hinge can be installed on single and double columns. In this case, to allow the drawers to be opened, the door must be opened to its maximum rotation

Attrezzatura — Inner accessories

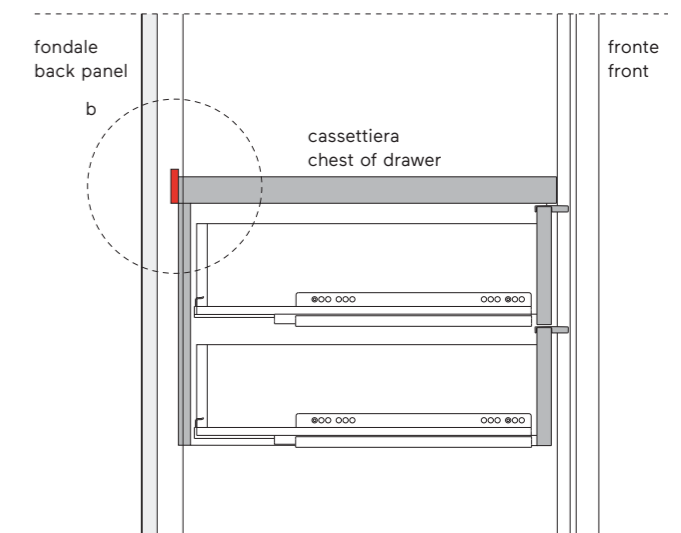
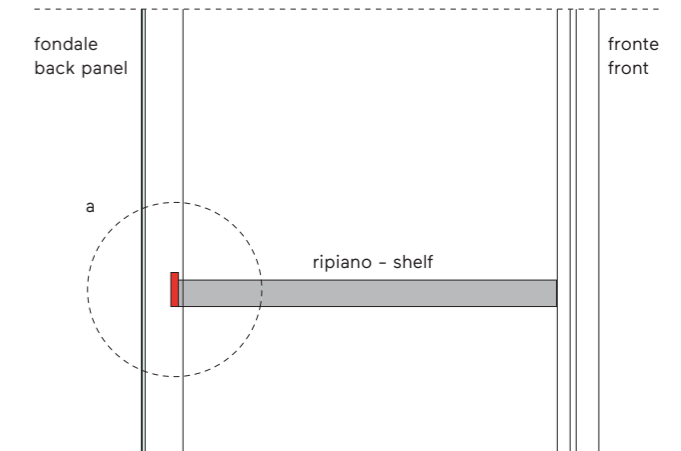
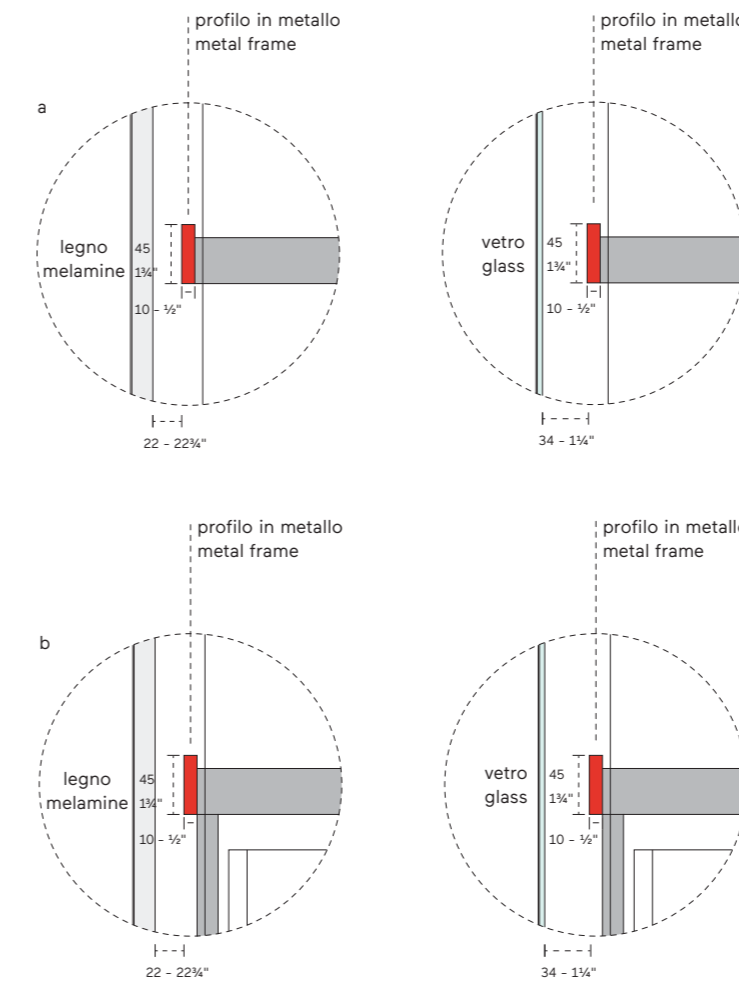

sezione struttura Tian
Tian structure section

Attrezzatura disponibile* Available equipment*

È possibile inserire le attrezzature descritte da pag. 166 a pag. 249 per realizzare tutte le combinazioni desiderate

In presenza di fondale in vetro o melaminico Tian è prevista l'applicazione di un profilo in metallo posizionato sul lato posteriore dei ripiani e dei top delle attrezzature

Equipment described from page 166 to page 249 can be fitted to enable you to find your desired combination

In the presence of glass or melamine back panel Tian, a metal profile is foreseen to be set both on the shelves back sides and equipments top

Attrezzatura non disponibile Not available equipment

Cassettiere con vano a giorno
Barra appendiabiti sezione tonda
Servetto
Fianco divisorio

Chest of drawers with open compartment
Hanger bar with round section
Wardrobe lift
Divider side

Posizioni Position

Per l'alloggiamento delle attrezzature su fianco interno o esterno Tian, è necessario l'utilizzo di uno o due traversi di supporto secondo composizione

One or two support traverses are required to fit equipment to Tian internal and external side, depending on the composition

* La griglia portacamicie è disponibile solo in presenza di fondale in melaminico Tian

Shirt rack only available with Tian melamine back panel

illuminazione verticale — Vertical illumination

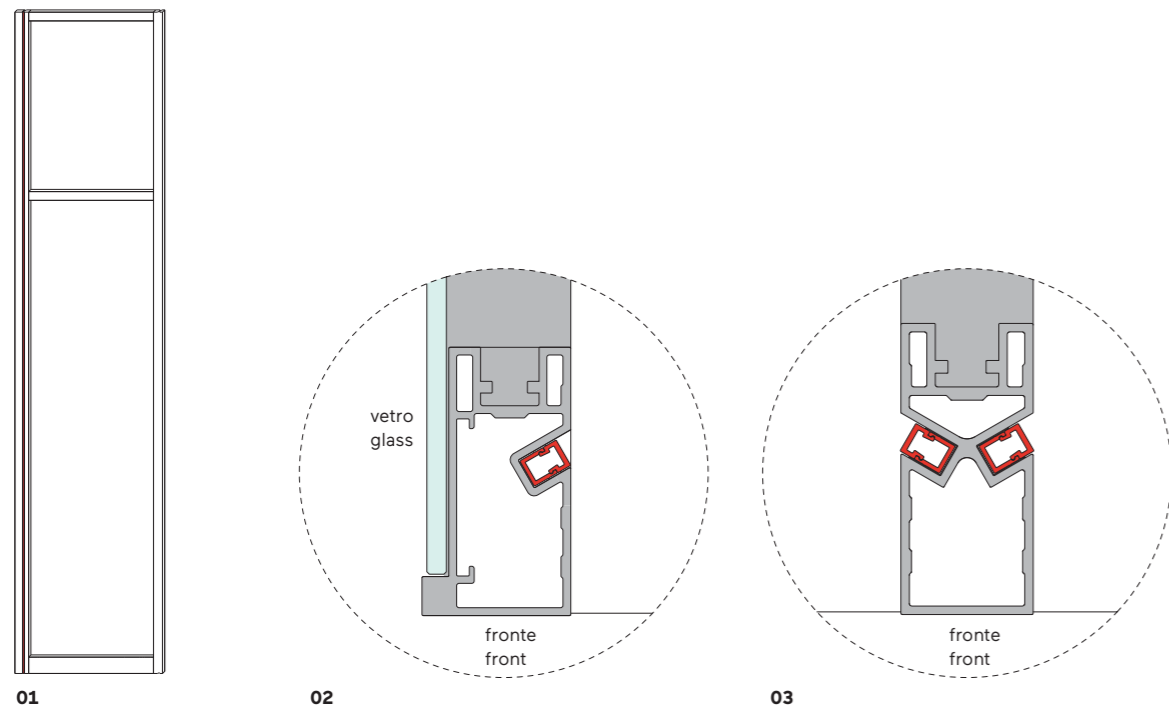

01

Lampada mini stripe Led per fianco Tian e anta Dandy

Mini stripe led for frame side panel

Incassata nei montanti anteriori dei fianchi Tian interni/esterni. Accensione automatica con sensore IR inserito nel coperchio, radiocomando in presenza di centralina dimmerabile o presa comandata presente in loco

Lampada a gradazione calda 3000° K - 110V o 230V

Altezza fianco Height of side	Potenza Power
2368 - 93¼"	W 22,73
2464 - 97"	W 23,83
2624 - 103¼"	W 25,30
2880 - 113½"	W 28,23

02

Lampada mini stripe Led per fianco Tian Open

Mini stripe led for frame side panel

Incassata nei montanti anteriori dei fianchi Tian interni/esterni. Accensione tramite radiocomando in presenza di centralina dimmerabile o presa comandata presente in loco

Lampada a gradazione calda 3000° K - 110V o 230V

Altezza fianco Height of side	Potenza Power
2368 - 93¼"	W 24,93
2464 - 97"	W 26,03
2624 - 103¼"	W 27,86
2880 - 113½"	W 30,43

03

02

Sezione fianco esterno Tian e mini stripe led.

Tian external side section and mini LED stripe

Automatic turning-on by radio control with control unit or socket

Warm light lamp 3000° K - 110V or 230V

Altezza fianco Height of side	Potenza Power
2368 - 93¼"	W 24,93
2464 - 97"	W 26,03
2624 - 103¼"	W 27,86
2880 - 113½"	W 30,43

03

Sezione fianco interno Tian e mini stripe led.

Possibilità di inserimento luce led sia a destra che a sinistra del montante

LED lighting can be positioned on both the left and right of the upright



Illuminazione orizzontale Horizontal lighting

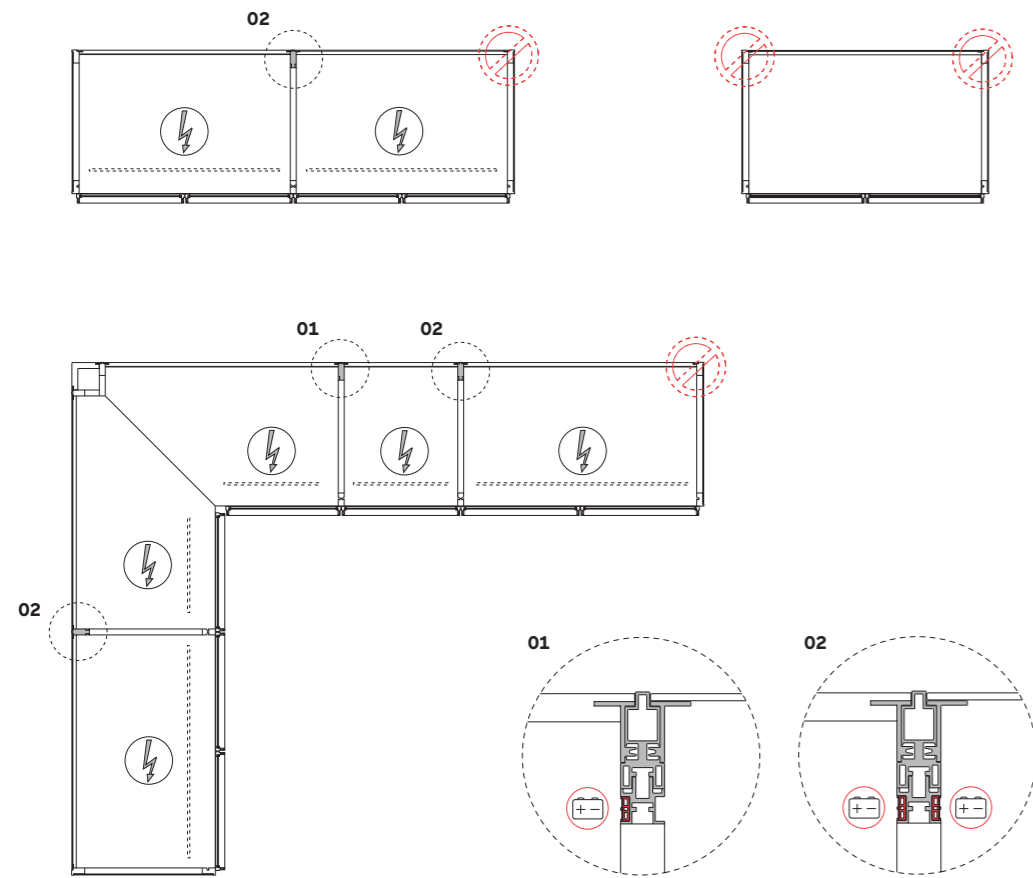

Profilo elettrificato Electrified profile

L'illuminazione orizzontale è disponibile esclusivamente con profilo elettrificato. L'utilizzo del profilo permette l'attivazione delle stripe led presenti all'interno dell'armadio e applicate alle attrezzature. La presenza di questo profilo garantisce il riposizionamento delle attrezzature all'altezza desiderata e l'aggiunta di ulteriori accessori successivamente all'ordine effettuato

Horizontal lighting is only available with an electrified profile. The use of the profile allows the activation of LED stripes inside the wardrobe and fitted in equipment. The presence of this profile guarantees the repositioning of the equipment at the desired height and the addition of further accessories after the order has been placed

01 - 02 Regole installazione profilo elettrificato Rules for installation of electrified profile

- il profilo è disponibile esclusivamente nei fianchi interni Tian
- il profilo è sempre alloggiato sul lato sinistro del fianco interno
- è possibile installare un solo profilo elettrificato per colonna d'armadio ad eccezione della colonna ad angolo dove il profilo è previsto su entrambi i fianchi interni
- non è possibile illuminare una colonna singola Tian tramite profilo elettrificato

- profile only available in Tian internal sides
- profile located on left side of internal side panels
- it is possible to install only one electrified profile per wardrobe column, except for the corner column where the profile is provided on both internal sides
- it is not possible to illuminate a Tian single column by means of an electrified profile

Schema illuminazione — Lighting details

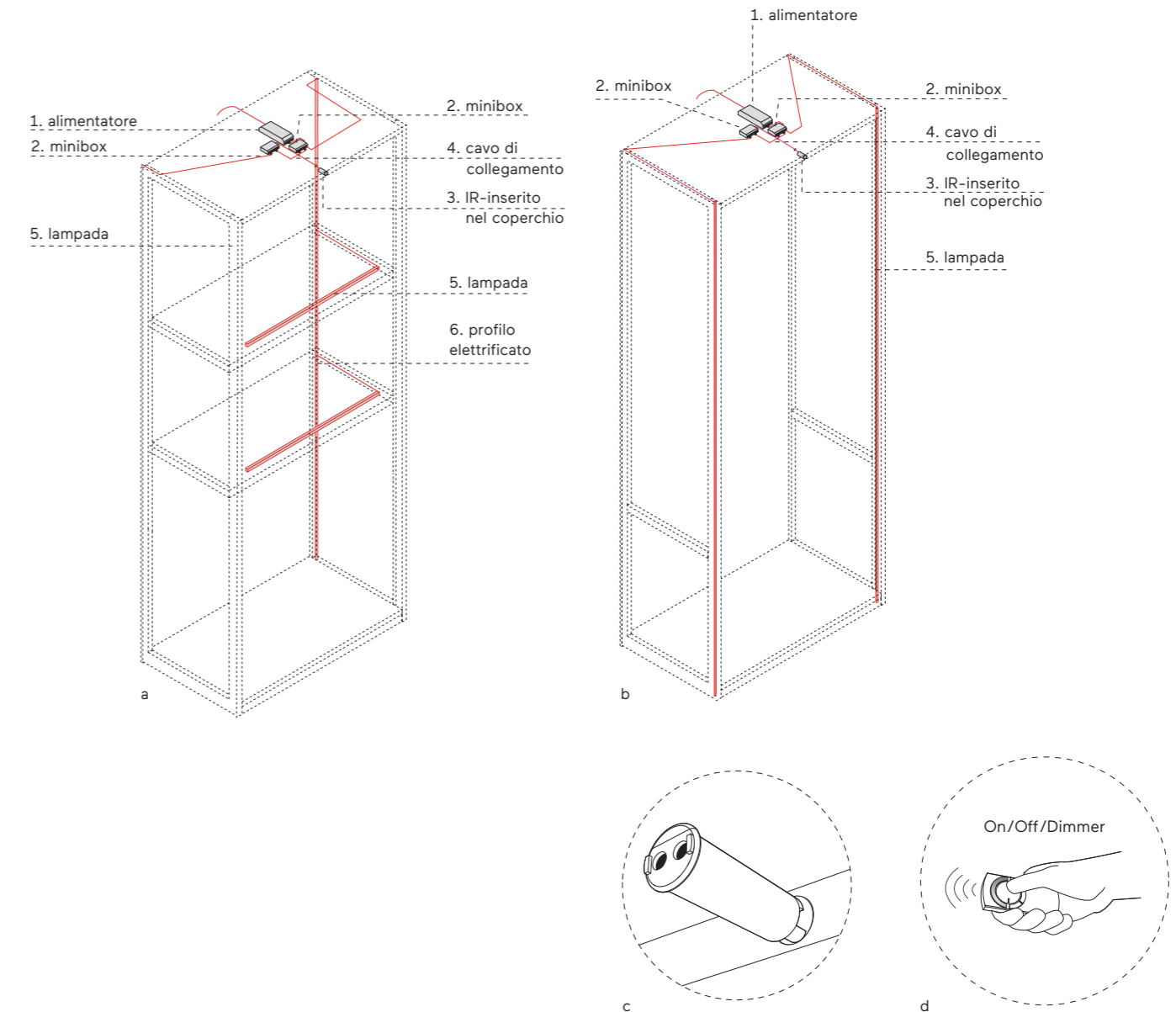

Descrizione Description

- Schema illuminazione orizzontale tramite profilo elettrificato
- Schema illuminazione verticale
- Accensione tramite sistema IR inserito nel coperchio
- Accensione tramite radiocomando, quando presente la centralina dimmerabile

- Horizontal lighting layout using conduit
- Vertical lighting layout
- Turning-on by IR system inserted in top
- Turning-on by radio control, where dimmer present

Illuminazione ed accensione Lighting and turning-on

I sistemi d'illuminazione LED sono a luce calda 3000°K

- tramite sensore IR inserito nel coperchio con ante battenti
- tramite presa comandata prevista in loco
- tramite radiocomando quando presente la centralina dimmerabile*

LED lighting systems are warm light 3000° K

- by IR sensor inserted in top with hinged doors
- by socket installed in situ
- by radio control, where dimmer present*

* Il kit opzionale dimmerabile è composto da una centralina per ogni alimentatore presente nella composizione e radiocomando integrato

The optional dimmable kit features one control unit per power supply for each composition, together with an integrated radio control



5.

INTERNAL ACCESSORIES

Lema propone svariate soluzioni per allestire l'interno dell'armadio al fine di soddisfare ogni tipo di necessità. Le numerose attrezzature disponibili permettono di personalizzare l'armadio adattandosi a qualsiasi tipo di utilizzo ottimizzando al massimo gli spazi in esso contenuti. Lema, con un programma sartoriale unico nel suo genere, riconferma la sua vocazione alla modularità e alla personalizzazione. Un modo differente di intendere l'armadio, pensato non solo per l'ordine, ma per il piacere di arredare un luogo dedicato a sé stessi e agli oggetti più personali. Una presenza discreta, nel segno della qualità e della tradizione Lema.

Lema offers a range of options to kit out the interior of the wardrobe, ensuring all requirements can be met. The numerous equipments available mean each wardrobe can be completely customised, adapting to any type of use and optimising the space of each piece. With a one-of-a-kind bespoke programme, Lema reconfirms its vocation in modular designs and customisation. A different way to understand the wardrobe, designed not only for keeping things tidy, but for the pleasure of furnishing a place dedicated to yourselves and your most treasured objects. A discreet presence, celebrating quality and Lema traditions.

Allestimento interno — Internal accessories

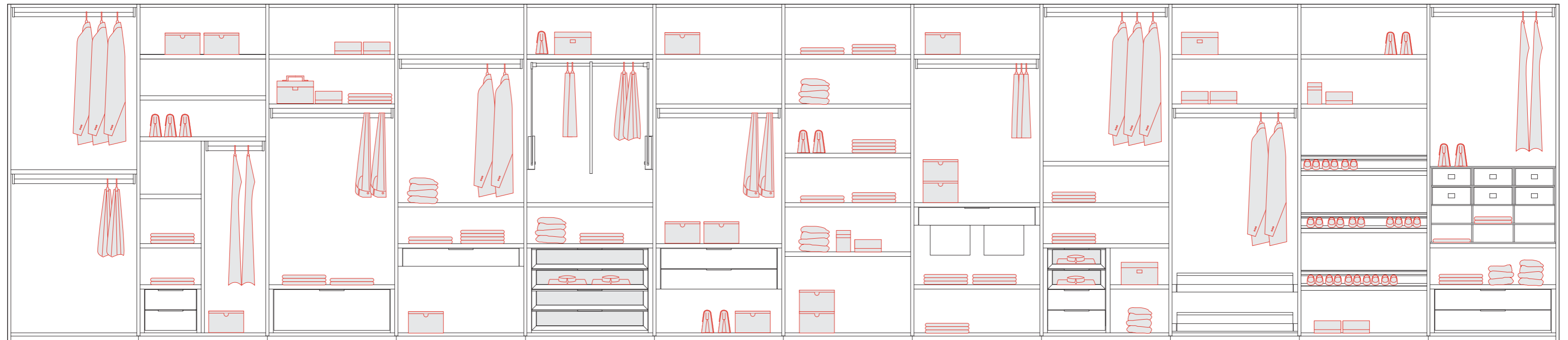

01	02	03	04	05	06	07	08	09	10	11	12
1 ripiano, 2 barre appendiabiti	1 barra appendiabiti, 5 ripiani, 1 cassettera con 2 cassetti, 1 fianco divisorio	1 barra appendiabiti, 2 ripiani, 1 cassetto alto	1 barra appendiabiti, 2 ripiani, 1 vassoio estraibile	1 servetto, 2 ripiani, 1 cassettera con 4 cassetti	1 barra appendiabiti, 2 ripiani, 1 cassettera sospesa	5 ripiani	1 barra appendiabiti, 2 ripiani, 1 vassoio portabiancheria estraibile	1 barra appendiabiti, 2 ripiani, 1 cassettera con vani a giorno	1 barra appendiabiti, 2 ripiani, 2 vassoi portascarpe estraibili	2 ripiani, 3 ripiani portascarpe fissi	1 barra appendiabiti, 1 cassettera con 2 cassetti, 1 griglia portacamicie
1 shelf, 2 hanging bars	1 hanging bar, 5 shelves, 1 drawer unit with 2 drawers, 1 partition side	1 hanging bar, 2 shelves, 1 high drawer	1 hanging bar, 2 shelves, 1 extractable tray	1 pull down hanging bar, 2 shelves, 1 drawer unit with 4 drawers	1 hanging bar, 2 shelves, 1 suspended drawer unit	5 shelves	1 hanging bar, 2 shelves, 1 extractable laundry basket	1 hanging bar, 2 shelves, 1 drawer unit with open element	1 hanging bar, 2 shelves, 2 tilted shoe racks	2 shelves, 3 tilted shoe racks	1 hanging bar, 1 drawer unit with 2 drawers, 1 shirt rack

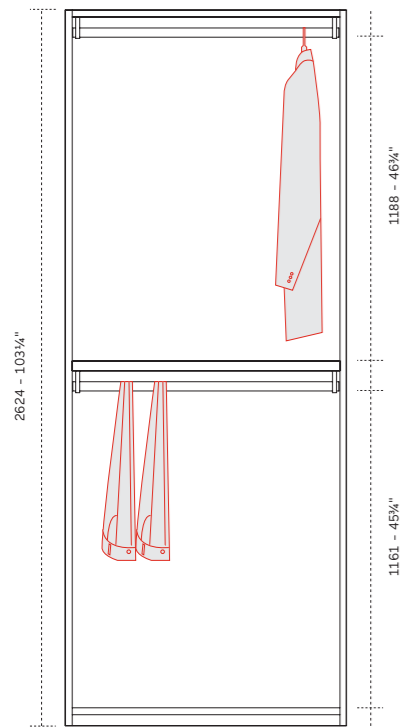

01

- 2 barre appendiabiti,
- 1 ripiano
- 2 hanging bars, 1 shelf

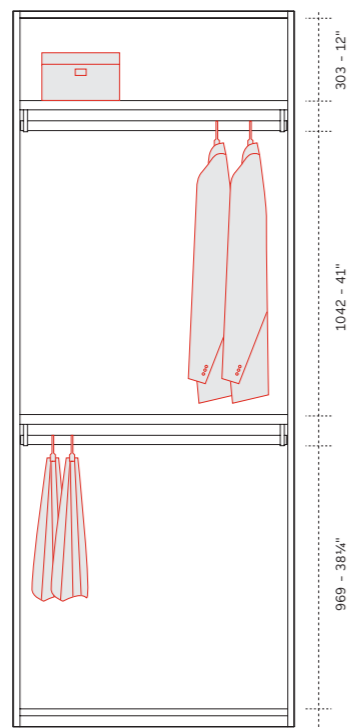

01 a

- 2 barre appendiabiti,
- 2 ripiani
- 2 hanging bars, 2 shelves

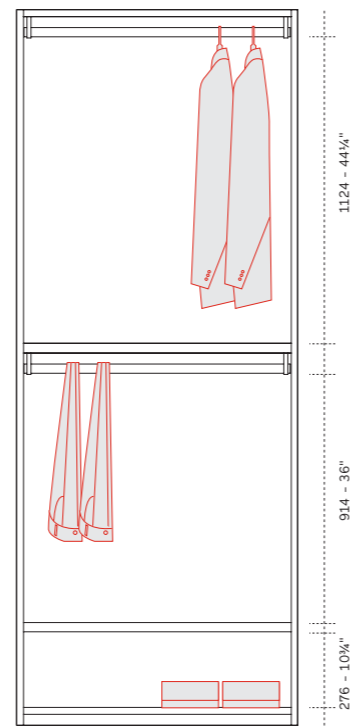

01 b

- 2 barre appendiabiti,
- 2 ripiani
- 2 hanging bars, 2 shelves

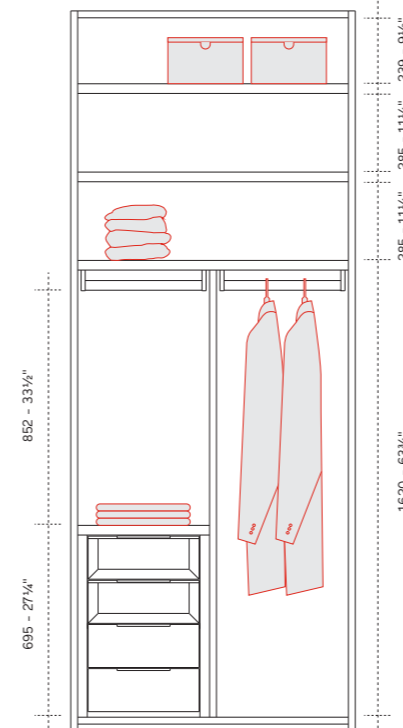

02

- 2 barre appendiabiti,
- 3 ripiani 1 cassetiera con 4 cassetti,
- 1 fianco divisorio
- 2 hanging bars, 3 shelves
- 1 drawer unit with 4 drawers,
- 1 partition side

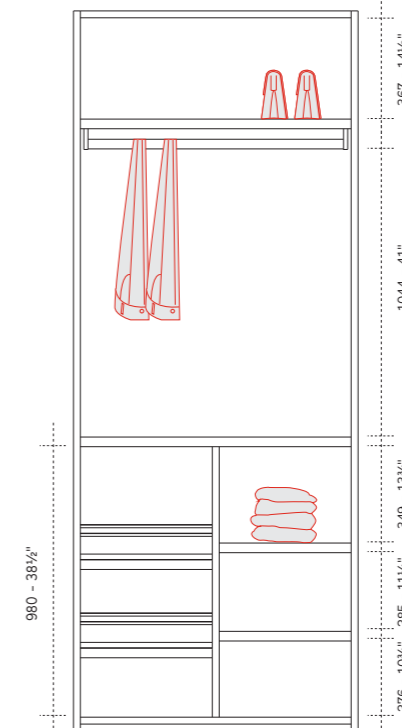

02 a

- 1 barra appendiabiti,
- 4 ripiani
- 2 ripiani portascarpe fissi,
- 1 fianco divisorio
- 1 hanging bar, 4 shelves
- 2 tilted shoe rack,
- 1 partition side

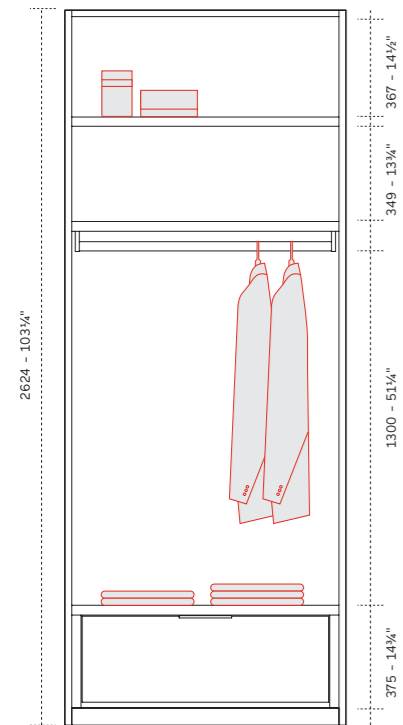

03

- 1 barra appendiabiti,
- 2 ripiani, 1 cassetto alto
- 1 hanging bar, 2 shelves,
- 1 high drawer

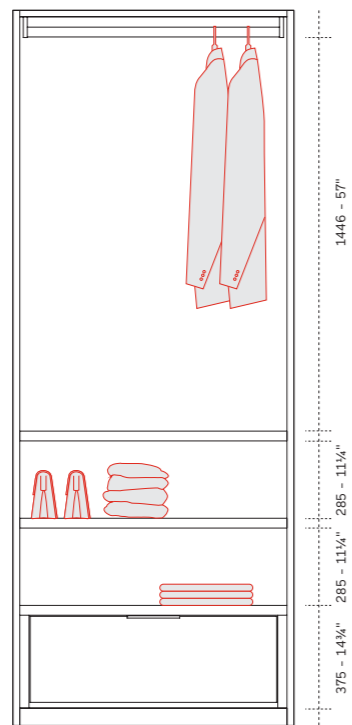

03 a

- 1 barra appendiabiti,
- 2 ripiani, 1 cassetto alto
- 1 hanging bar, 2 shelves,
- 1 high drawer

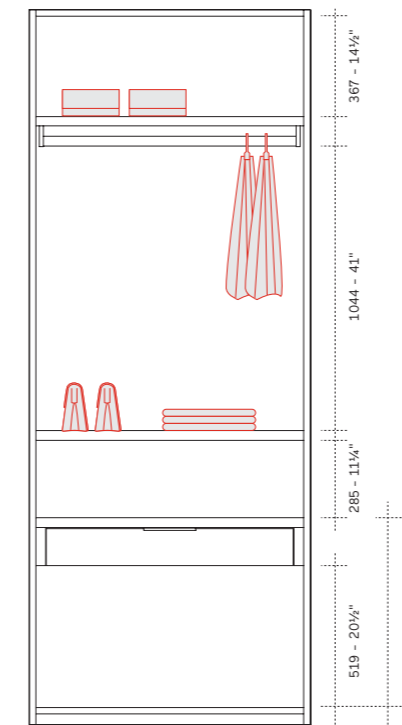

04

- 1 barra appendiabiti,
- 2 ripiani, 1 vassoio estraibile
- 1 hanging bar, 2 shelves,
- 1 extractable tray

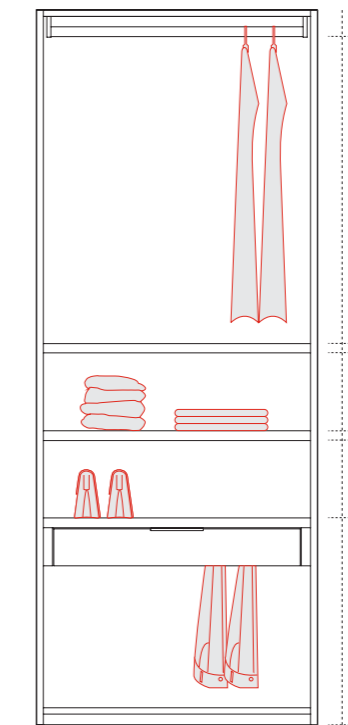

04 a

- 1 barra appendiabiti,
- 2 ripiani, 1 portapantaloni estraibile
- 1 hanging bar, 2 shelves,
- 1 extractable tray

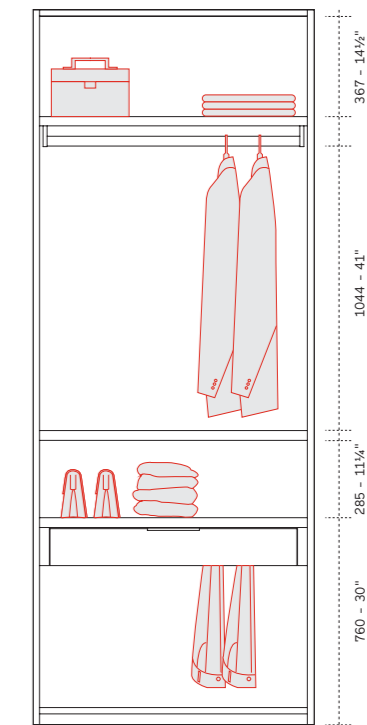

04 b

- 1 barra appendiabiti,
- 2 ripiani, 1 portapantaloni estraibile
- 1 hanging bar, 2 shelves,
- 1 extractable tray

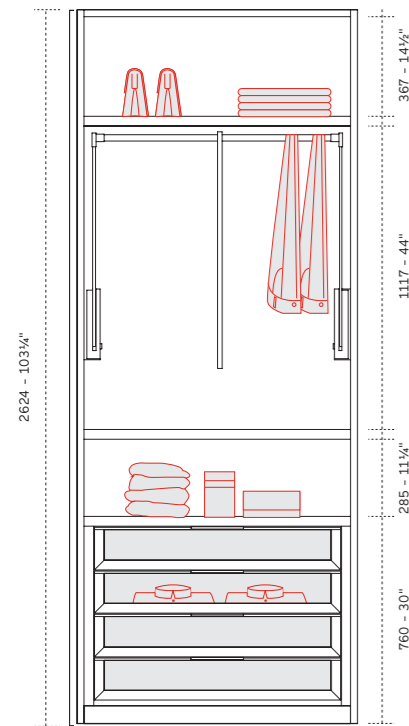

05

1 servetto, 2 ripiani,
1 cassetiera con 4 cassetti

1 pull down hanging bar,
2 shelves, 1 drawer unit
with 4 drawers

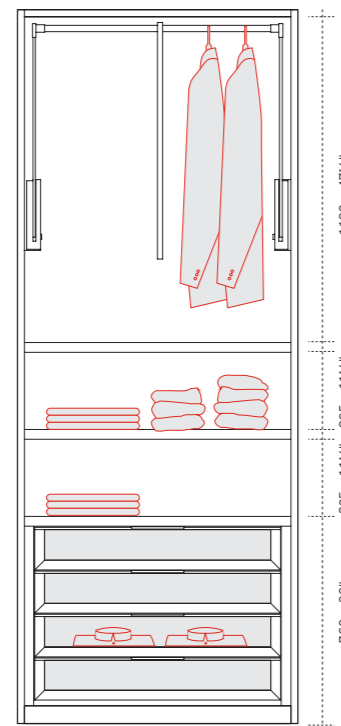

05 a

1 servetto, 2 ripiani,
1 cassetiera con 4 cassetti

1 pull down hanging bar,
2 shelves, 1 drawer unit
with 4 drawers

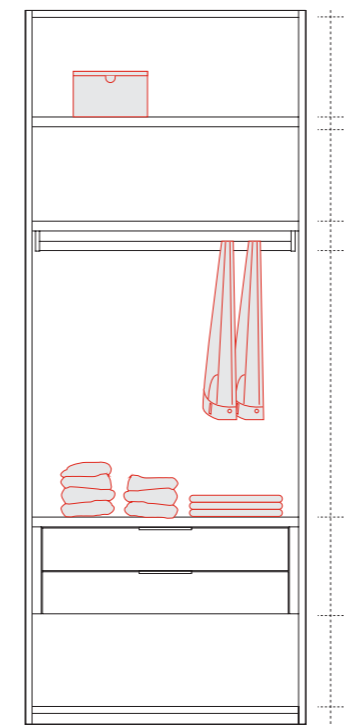

06

1 barra appendiabiti,
2 ripiani, 1 cassetiera
sospesa con 2 cassetti

1 hanging bar, 2 shelves,
1 suspended drawer unit
with 2 drawers

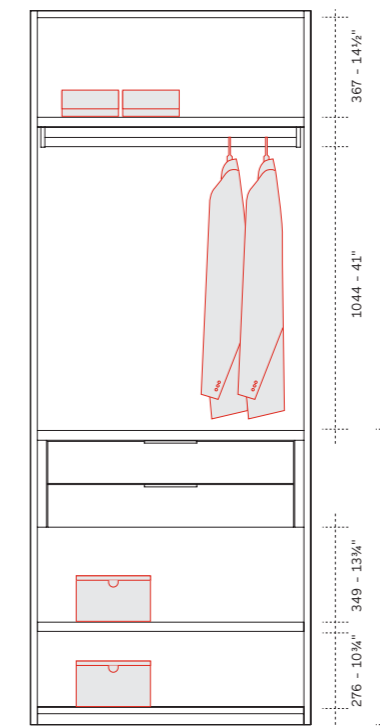

06 a

1 barra appendiabiti,
2 ripiani, 1 cassetiera
sospesa con 2 cassetti

1 hanging bar, 2 shelves,
1 suspended drawer unit
with 2 drawers

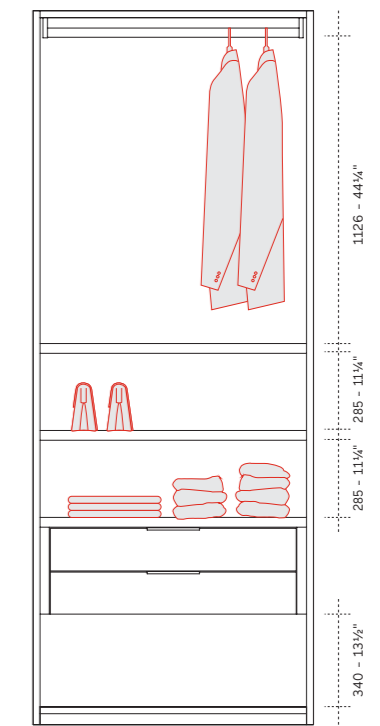

06 b

1 barra appendiabiti,
2 ripiani, 1 cassetiera
sospesa con 2 cassetti

1 hanging bar, 2 shelves,
1 suspended drawer unit
with 2 drawers

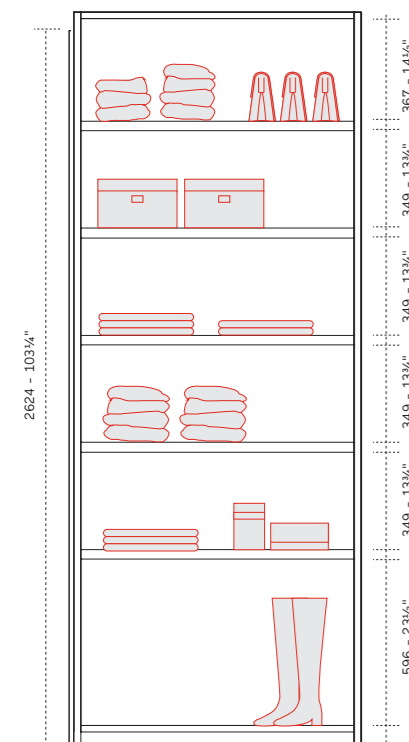

7

5 ripiani

5 shelves

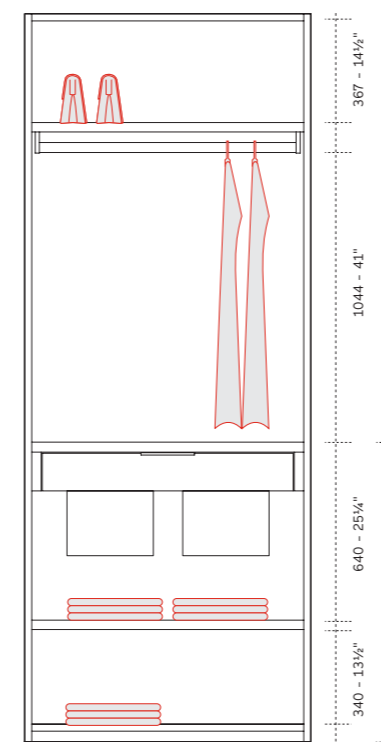

08

1 barra appendiabiti,
2 ripiani, 1 vassoio
portabiancheria estraibile

1 hanging bar, 2 shelves,
1 extractable laundry basket

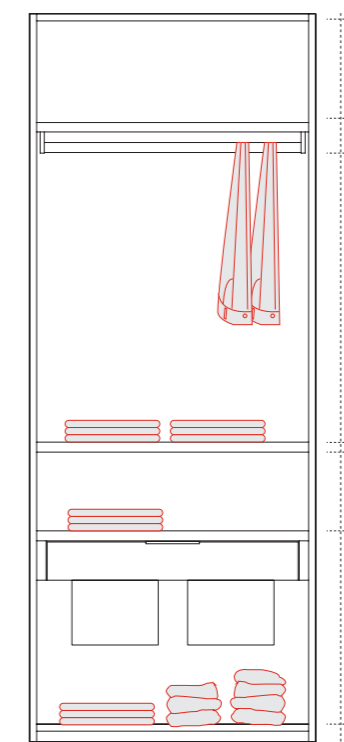

08 a

1 barra appendiabiti,
2 ripiani, 1 vassoio
portabiancheria estraibile

1 hanging bar, 2 shelves,
1 extractable laundry basket

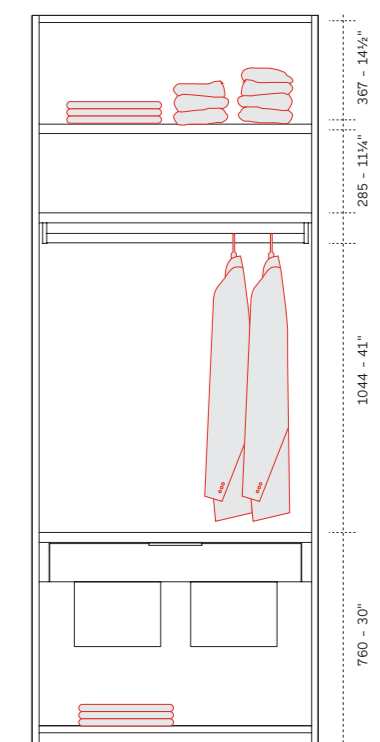

08 b

1 barra appendiabiti,
2 ripiani, 1 vassoio
portabiancheria estraibile

1 hanging bar, 2 shelves,
1 extractable laundry basket

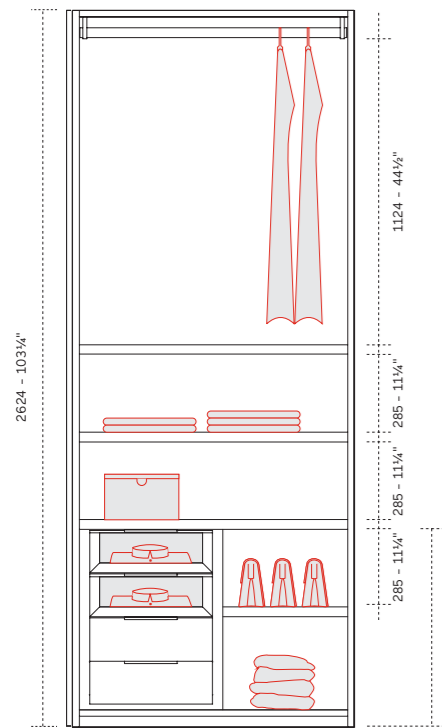

01

2 barre appendiabiti,
1 ripiano

2 hanging bars, 1 shelf

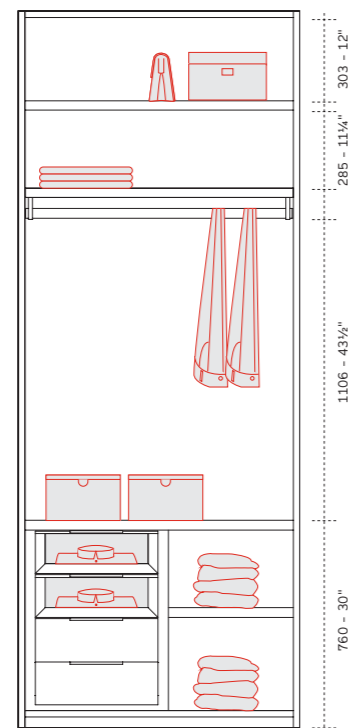

09 a

1 barra appendiabiti, 2 ripiani,
1 cassettera con vani a giorno

1 hanging bar, 2 shelves,
1 drawer unit with open element

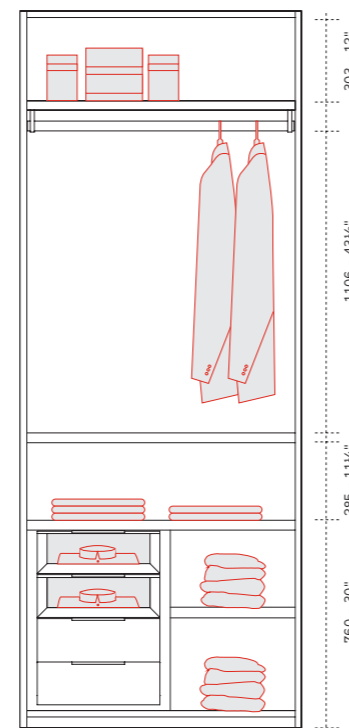

09 b

1 barra appendiabiti, 2 ripiani,
1 cassettera con vani a giorno

1 hanging bar, 2 shelves,
1 drawer unit with open element

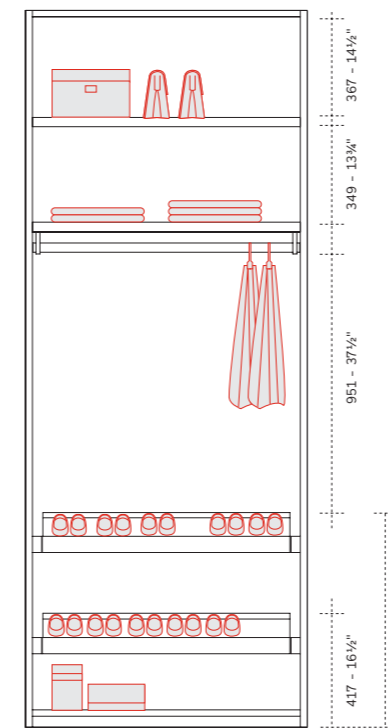

10

1 barra appendiabiti, 2 ripiani,
2 vassoi portascarpe estraibili

1 hanging bar, 2 shelves,
2 extractable shoe racks

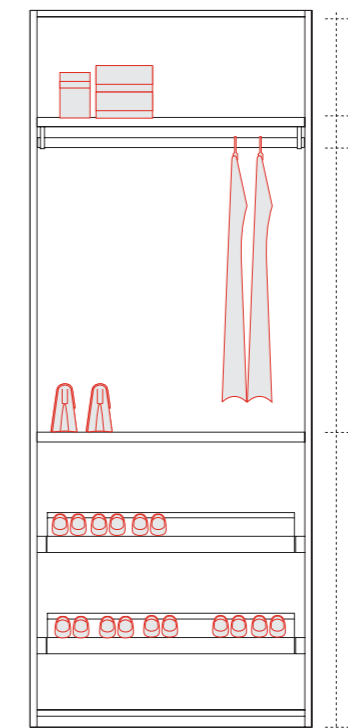

10 a

1 barra appendiabiti, 2 ripiani,
2 vassoi portascarpe estraibili

1 hanging bar, 2 shelves,
2 extractable shoe racks

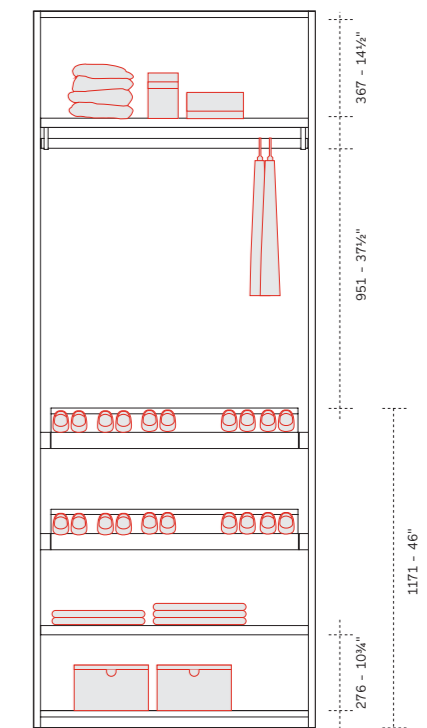

10 b

1 barra appendiabiti, 2 ripiani,
2 vassoi portascarpe estraibili

1 hanging bar, 2 shelves,
2 extractable shoe racks

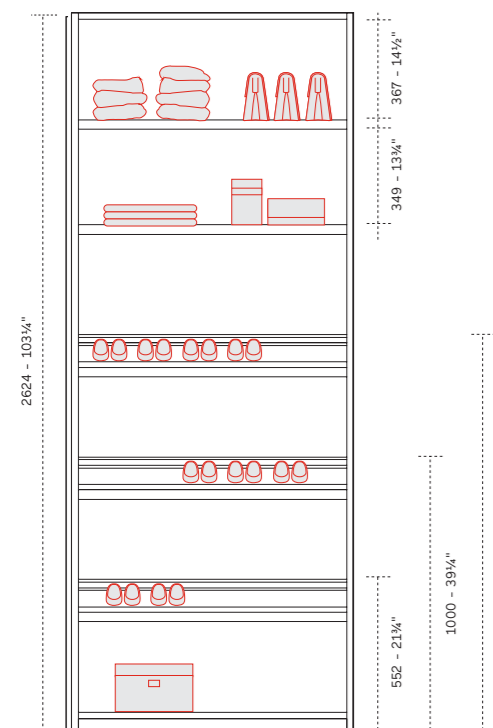

11

2 ripiani, 3 ripiani portascarpe fissi

2 shelves, 3 tilted shoe racks

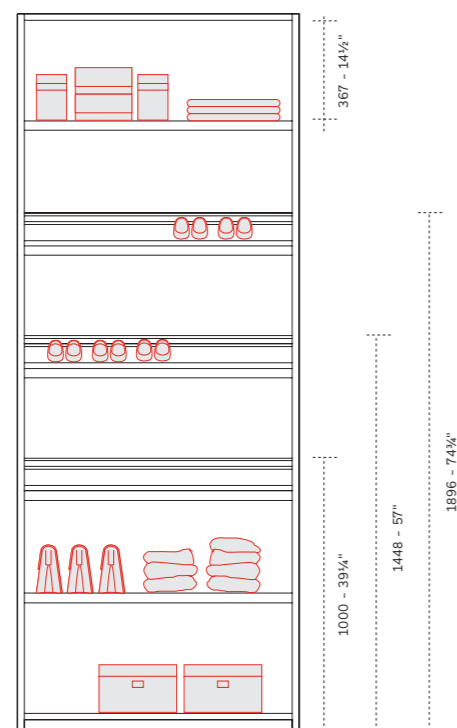

11 a

2 ripiani, 3 ripiani portascarpe fissi

2 shelves, 3 tilted shoe racks

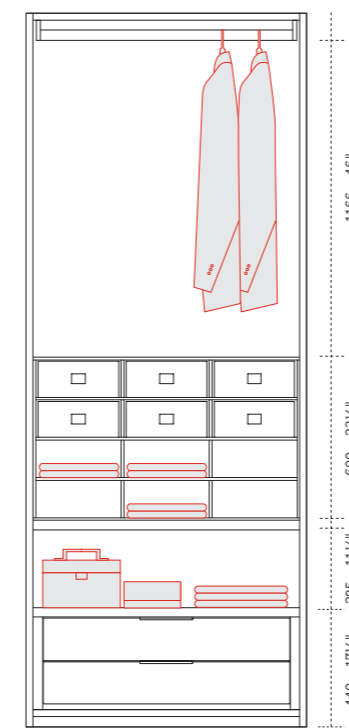

12

1 barra appendiabiti, 1 ripiano, 1 cassettera
con 2 cassetti, 1 griglia portacamicie

1 hanging bar, 1 shelf, 1 drawer unit
with 2 drawers, 1 shirts holders

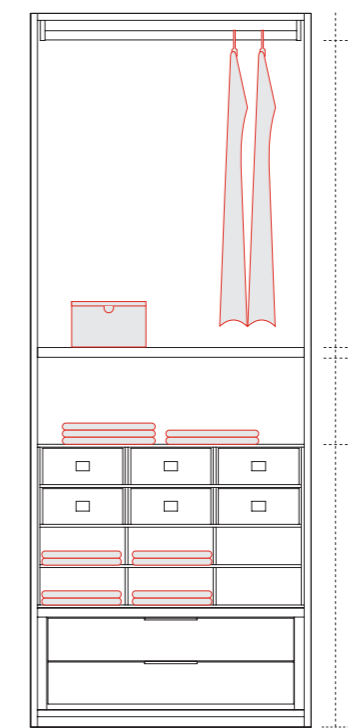

12 a

1 barra appendiabiti, 1 ripiano, 1 cassettera
con 2 cassetti, 1 griglia portacamicie

1 hanging bar, 1 shelf, 1 drawer unit
with 2 drawers, 1 shirts holders

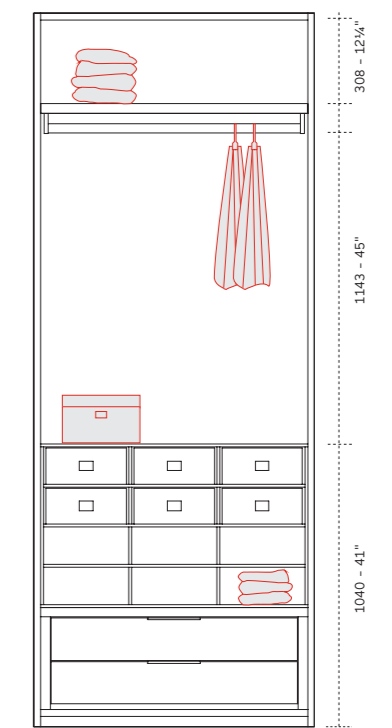

12 b

1 barra appendiabiti, 1 ripiano, 1 cassettera
con 2 cassetti, 1 griglia portacamicie

1 hanging bar, 1 shelf, 1 drawer unit
with 2 drawers, 1 shirts holders

Finiture attrezzatura — Accessories finishings

Una gamma di attrezzature in costante evoluzione; un'estesa scelta di misure, materiali e finiture che assicurano la massima personalizzazione per soddisfare necessità estetiche e funzionali. Le attrezzature interne, disponibili nelle versioni Comfort e Tech, abbinano melaminici dai delicati colori e raffinati metalli.

A range of equipment in constant evolution and a huge choice of measurements, materials and finishings, resulting in fully customised pieces, which meet all aesthetic and practical requirements. The internal equipment, available in the Comfort and Tech versions, combines delicately coloured melamines with sophisticated metal.

Melaminici Melamines

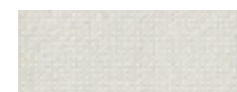

Canvas



Lino



Larice sbiancato
Bleached larch



Larice grigio
Grey larch

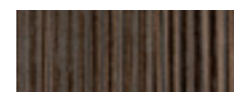

Larice moka
Moka larch

Profili, maniglie e dettagli Profile, handles and details



Visone



Metallo verniciato bronzo
epox M421 - Metal
bronze epox painted M42



Metallo verniciato sand
epox M455 - Metal sand
epox painted M455



Attrezzatura Comfort e Tech

Comfort and Tech accessories

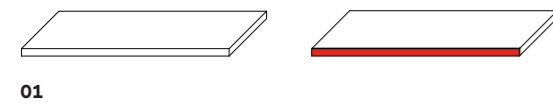

01

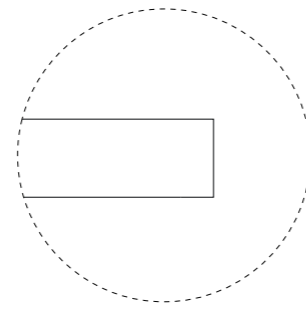

Comfort

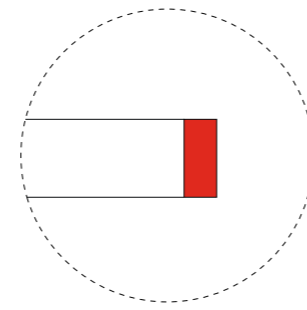

Tech

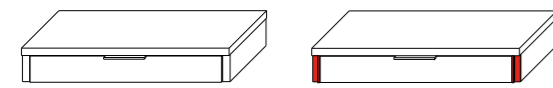

02

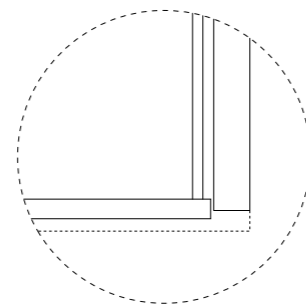

Comfort

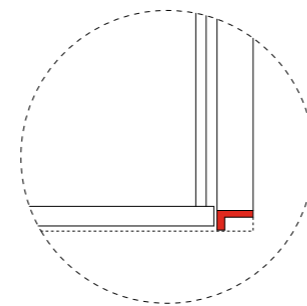

Tech



Vassoio portabiancheria estraibile - Comfort
Extractable linen tray - Comfort

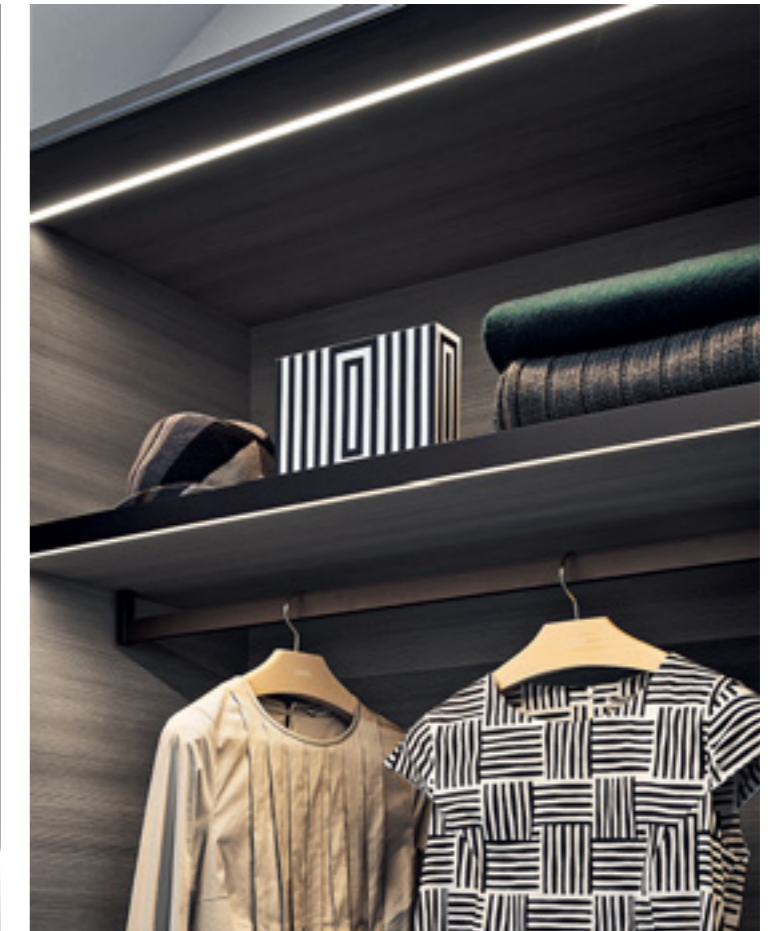

Ripiano con luce - Tech
Shelf with light - Tech

01
Ripiani
Shelves

Finiture struttura
Structure finishings

Melaminico canvas
Melaminico lino
Melaminico visone
Melaminico larice
sbiancato
Melaminico larice grigio
Melaminico moka

Melamine canvas
Melamine lino
Melamine visone
Melamine bleached larch
Melamine larch grey
Melamine moka

Maniglia e profili*
Handle and profiles*

Metallo verniciato
bronzo epox M421
sand epox M455

Metal painted
bronze epox M421
sand epox M455

*

Profili orizzontali
e verticali in metallo
solo per versione
Tech

Horizontal and
vertical profiles in
metal only for Tech
version

Fianco divisorio — Partition side

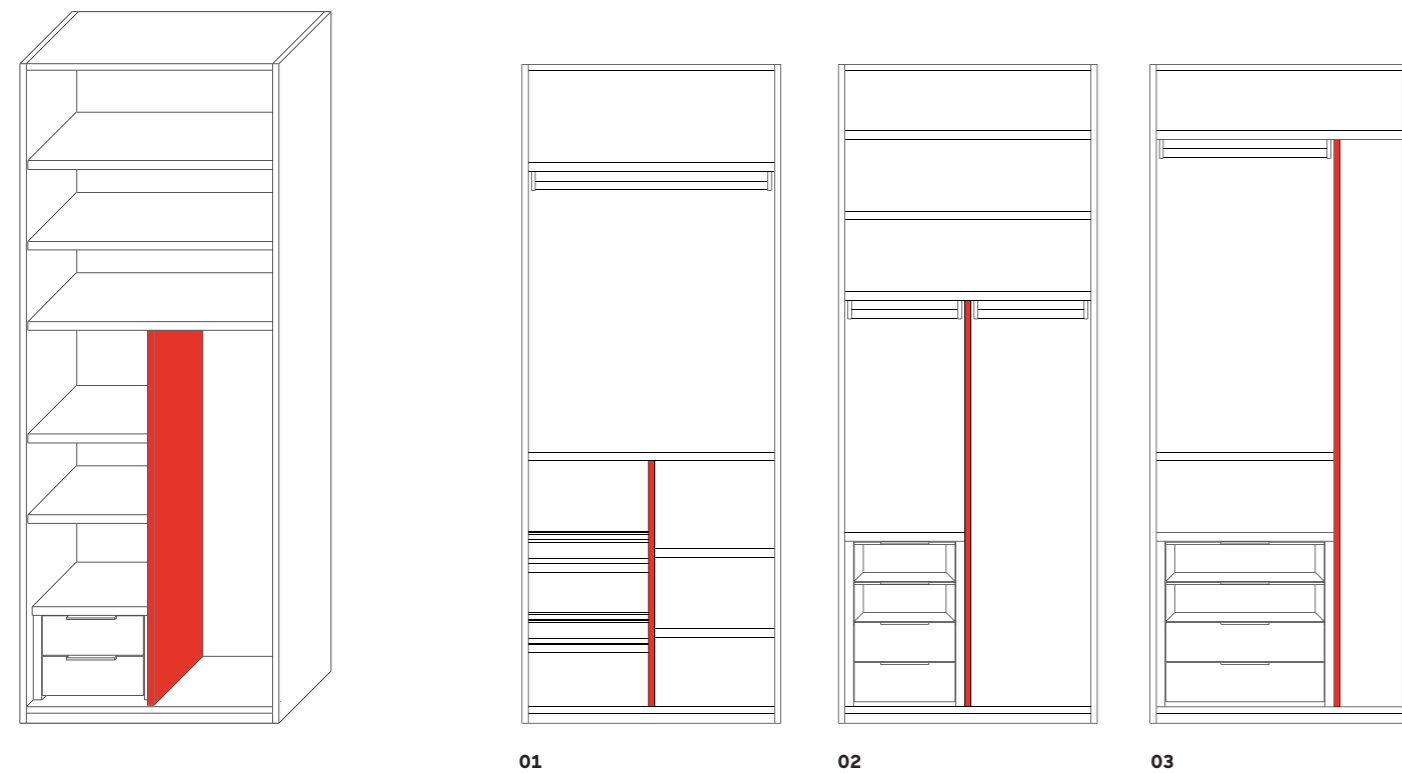

Fianco divisorio
Partition side
Fianco non strutturale, da fissare alla base e sotto-ripiano. Utilizzato per suddividere le larghezze di vano standard in due porzioni di spazio attrezzabili con: cassettiere, ripiani, ripiani portascarpe e barre appendiabiti

No-structural side panel, to be fixed on base and under the shelf. It allows standard column to be divided into two different areas, that can be set with chest of drawers, shelves, tilted shoe racks and hanging bars

Altezza
Height
980 - 1620 - 2260
38½" - 63¾" - 89"

Profondità
Depth
356 - 500
14" - 19¾"

Spessore
Thickness
25 - 1"
Finiture
Finishings
Melaminico 6 varianti
Melamine 6 type

Informazioni utili
Useful information
Non utilizzabile in presenza di fondale in vetro
Cannot be used with a glass back panel

01 - 02 - 03
Esempi di composizioni
Composition examples

Supporto strutturale — Structural support

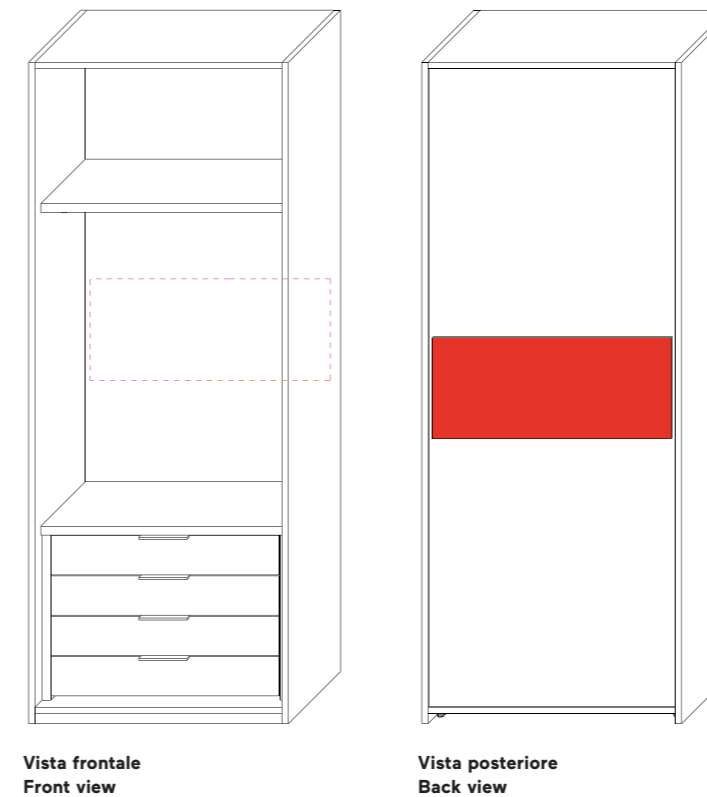

Vista frontale
Front view

Vista posteriore
Back view

Supporto strutturale
Structural support
Il "supporto strutturale fondale" è un dispositivo utile al fine di evitare problemi di flessione nei fondali dell'armadio, in alcune tipologie di larghezza ritenute più sensibili a questo fenomeno

The "back panel structural support" is designed to prevent wardrobe back panels from bending, as some widths are more susceptible to this

Altezza
Height
400 - 15¾"

Larghezza
Width
Per colonna da
889 - 981 - 1165

For column width
35" - 38½" - 45¾"

Informazioni utili
Useful information
Il dispositivo è preinstallato da Lema direttamente sul fondale in melaminico e non comporta alcun tipo di modifica

Device pre-installed by Lema in the melamine back panel, requiring no modification

Ripiani — Shelves

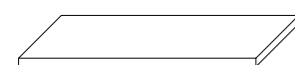

01

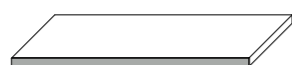

02



03



04



05

01	02	03	*
Ripiano Comfort Comfort shelf	Ripiano Tech Tech shelf	Tappetino per ripiano* Leather pad for shelf*	Disponibile solo per profondità fianco 586 Available only for side depth 23"
Larghezza Width 432 - 478 - 570 - 707 - 889 - 981 - 1165 17" - 18¾" - 22½" - 27¾" - 35" - 38½" - 45¾"	Larghezza Width 432 - 478 - 570 - 707 - 889 - 981 - 1165 17" - 18¾" - 22½" - 27¾" - 35" - 38½" - 45¾"	Larghezza Width Per colonna da 432 - 478 - 570 - 707 - 889 - 981 - 1165 For column width 17" - 18¾" - 22½" - 27¾" - 35" - 38½" - 45¾"	
Spessore Thickness 35 - 1½"	Spessore Thickness 35 - 1½"	Profondità Depth 497 - 19½"	
Profondità Depth 402 - 500 15¾" - 19¾"	Profondità Depth 409 - 507 16" - 20"	Finiture Finishings Pelle sintetica color moka Synthetic leather moka colour	
Finiture Finishings Melaminico 6 varianti Melamine 6 types	Finiture Finishings Ripiano in melaminico 6 varianti con profilo frontale in metallo verniciato epox bronzo o sand Shelf in 6 versions of melamine with front profile in sand or bronze epox painted metal		

04	05	Nota
Ripiano vetro Glass shelf	Ripiano in pelle sintetica Synthetic leather shelf	Note In presenza di fianco interno telaio o fianco esterno vetro, considerare uno o due trasversi di supporto Where an internal frame side or external side in glass is present, consider using one or two support traverses
Larghezza Width 432 - 478 - 570 - 707 - 889 - 981 - 1165 17" - 18¾" - 22½" - 27¾" - 35" - 38½" - 45¾"	Larghezza Width 432 - 478 - 570 - 707 - 889 - 981 - 1165 17" - 18¾" - 22½" - 27¾" - 35" - 38½" - 45¾"	
Spessore Thickness 35 - 1½"	Spessore Thickness 35 - 1½"	
Profondità Depth 500 - 19¾"	Profondità Depth 500 - 19¾"	
Finiture Finishings Ripiano in vetro trasparente con telaio in metallo verniciato: bronzo epox M421 sand epox M455 Shelf in transparent glass Frame in metal painted: bronze epox M421 sand epox M455	Finiture Finishings Ripiano in pelle sintetica con telaio in metallo verniciato: bronzo epox M421 sand epox M455 Shelf in synthetic leather Frame in metal painted: bronze epox M421 sand epox M455	

Ripiani — Shelves

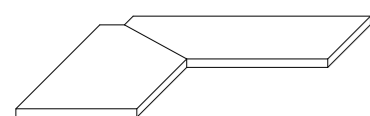

06

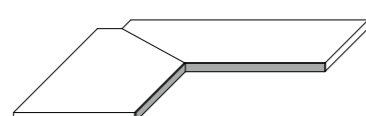

07

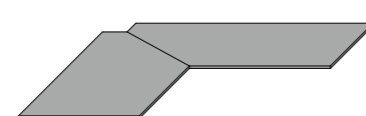

08

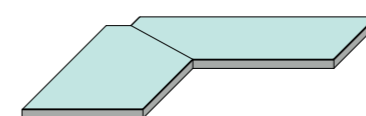

09

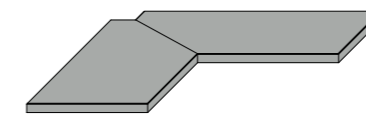

10

<p>06</p> <p>Ripiano angolare comfort Comfort shelf for corner element</p> <p>Dimensioni Dimensions</p> <p>Per fianco 586 For side 23" 1083 x 1083 42¾" x 42¾"</p> <p>Per fianco 442 For side 17½" 939 x 939 37" x 37"</p> <p>Spessore Thickness 35 - 1½"</p> <p>Profondità Depth 402 - 500 15¾" - 19¾"</p> <p>Finiture Finishings Melaminico 6 varianti Melamine 6 types</p>	<p>07</p> <p>Ripiano angolare tech Tech shelf for corner element</p> <p>Dimensioni Dimensions</p> <p>Per fianco da 586 For side 23" 1083 x 1083 42¾" x 42¾"</p> <p>Per fianco da 442 For side 17½" 939 x 939 37" x 37"</p> <p>Spessore Thickness 35 - 1½"</p> <p>Profondità Depth 409 - 507 16" - 20"</p>	<p>08</p> <p>Tappetino per ripiano angolare* Leather pad for corner shelf*</p> <p>Dimensioni Dimensions 978 x 978 38½" x 38½"</p> <p>Profondità Depth 497 - 19½"</p> <p>Finiture Finishings Pelle sintetica color moka Synthetic leather moka colour</p>	<p>*</p> <p>Disponibile solo per profondità fianco 586</p> <p>Available only for side depth 23"</p>
---	--	---	---

<p>09</p> <p>Ripiano angolare in vetro* Glass corner shelf*</p> <p>Dimensioni Dimensions 1083 x 1083 42¾" x 42¾"</p> <p>Spessore Thickness 35 - 1½"</p> <p>Profondità Depth 500 - 19¾"</p> <p>Finiture Finishings Ripiano in vetro trasparente Telaio in metallo verniciato: bronzo epox M421 sand epox M455</p> <p>Shelf in transparent glass Frame in metal painted: bronze epox M421 sand epox M455</p>	<p>10</p> <p>Ripiano angolare in pelle sintetica* Synthetic leather corner shelf*</p> <p>Dimensioni Dimensions 1083 x 1083 42¾" x 42¾"</p> <p>Spessore Thickness 35 - 1½"</p> <p>Profondità Depth 500 - 19¾"</p> <p>Finiture Finishings Ripiano in pelle sintetica Telaio in metallo verniciato: bronzo epox M421 sand epox M455</p> <p>Shelf in synthetic leather Frame in metal painted: bronze epox M421 sand epox M455</p>	<p>Nota Note</p> <p>In presenza di fianco interno telaio o fianco esterno vetro, considerare uno o due traversi di supporto</p> <p>Where an internal frame side or external side in glass is present, consider using one or two support traverses</p>
--	--	--



Ripiano Comfort
Ripiano realizzato in melaminico 6 varianti, disponibile per tutte le larghezze di vano, spessore mm. 35, profondità mm. 402 - 500, 15¾" - 19¾"

Comfort shelf
Shelf in a choice of 6 types of melamine, available for all element widths, thickness 1½", depth mm. 402 - 500, 15¾" - 19¾"



Ripiano Tech
Ripiano realizzato in melaminico 6 varianti, con frontale in metallo verniciato epox bronzo o sand. Disponibile per tutte le larghezze di vano, spessore mm. 35, profondità mm. 409 - 507, 16" - 20"

Tech shelf
Shelf in a choice of 6 types of melamine, with front in metal painted epox bronze or sand. Available for all element widths, thickness 1½", depth mm. 409 - 507, 16" - 20"



Ripiano in vetro trasparente
Ripiano in vetro trasparente, con telaio in metallo verniciato epox bronzo o sand. Disponibile per tutte le larghezze di vano indicate, spessore mm. 35, profondità mm. 500

Glass shelf
Shelf with transparent glass, in sand or bronze epox painted metal. Available for all element widths, thickness 1½", depth 19¾"



Ripiano in pelle sintetica
Ripiano in pelle sintetica color moka, con telaio in metallo verniciato epox bronzo o sand. Disponibile per tutte le larghezze di vano indicate, spessore mm. 35, profondità mm. 500

Synthetic leather shelf
Shelf in synthetic leather moka colour, with frame in sand or bronze epox painted metal. Available for all element widths, thickness 1½", depth 19¾"

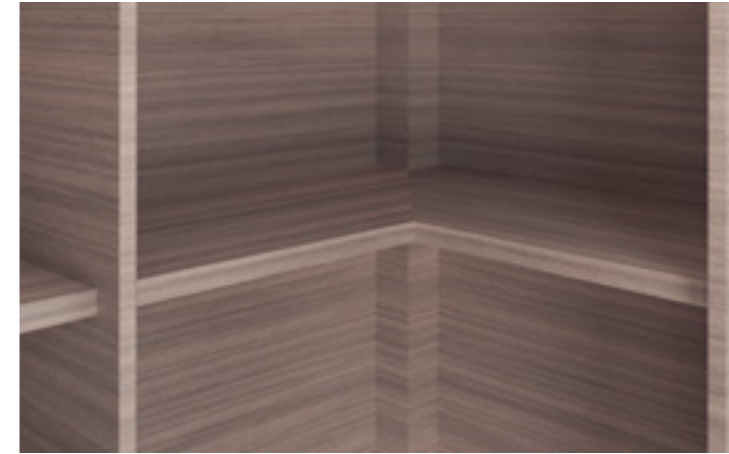

Ripiano angolare Comfort
Ripiano realizzato in melaminico 6 varianti, disponibile per colonne ad angolo, spessore mm. 35, profondità mm. 402 - 500, 15¾" - 19¾"

Comfort shelf for corner element
Shelf in a choice of 6 types of melamine, available for corner column, thickness 1½", depth mm 402 - 500, 15¾" - 19¾"

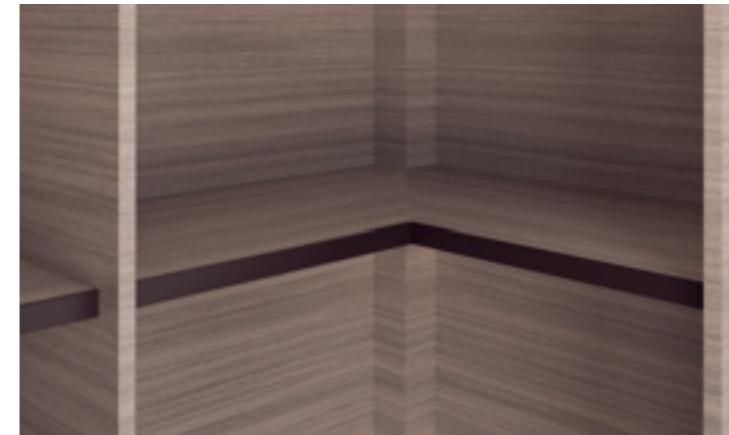

Ripiano angolare Tech
Ripiano realizzato in melaminico 6 varianti, con frontale in metallo verniciato epox bronzo o sand. Disponibile per colonne ad angolo, spessore mm. 35, profondità mm. 409 - 507, 16" - 20"

Tech shelf for corner column
Shelf in a choice of 6 types of melamine, with front in metal painted epox bronze or sand. Available for corner column, thickness 1½", depth mm 409 - 507, 16" - 20"

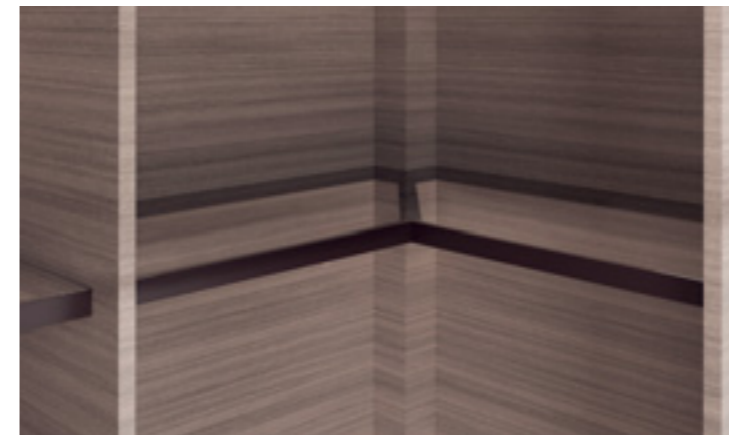

Ripiano angolare in vetro trasparente
Ripiano in vetro trasparente, con telaio in metallo verniciato epox bronzo o sand. Disponibile per colonne ad angolo, spessore mm. 35, profondità mm. 500 per fianco 586

Tech shelf for corner column
Shelf in a choice of 6 types of melamine, with front in metal painted epox bronze or sand. Available for corner column, thickness 1½", depth 19¾"

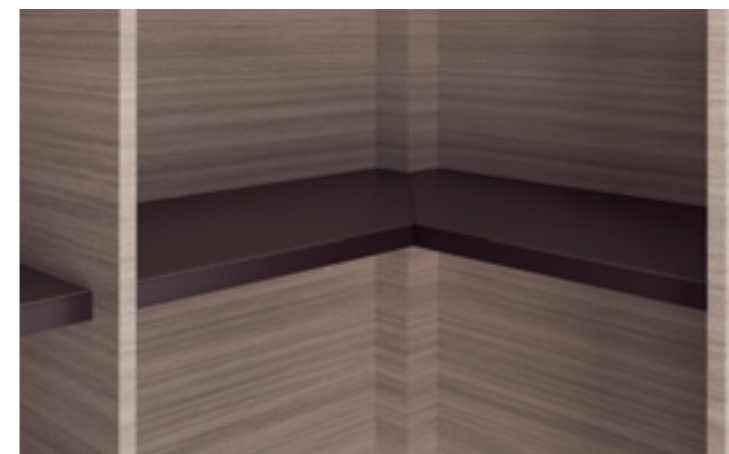

Ripiano angolare in pelle sintetica
Ripiano in pelle sintetica color moka, con telaio in metallo verniciato epox bronzo o sand. Disponibile per colonne ad angolo, spessore mm. 35, profondità mm. 500 per fianco 586

Tech shelf for corner column
Shelf in a choice of 6 types of melamine, with front in metal painted epox bronze or sand. Available for corner column, thickness 1½", depth 19¾"

Scarpiera — Shoe racks

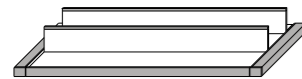

01

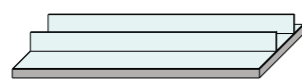

02

01	02
Vassoio portascarpe estraibile Extractable shoe rack	Ripiano portascarpe fisso in vetro Shoe rack in glass
Larghezza Width 889 - 981 - 1165 35" - 38½" - 45¾"	Larghezza Width 889 - 981 - 1165 35" - 38½" - 45¾"
Altezza Height 125 - 5"	Altezza Height 111 - 4¼"
Profondità Depth 500 - 19¾"	Profondità Depth 500 - 19¾"
Finiture Finishings Melaminico 6 varianti con dettagli in metallo verniciato: bronzo epox M421 sand epox M455	Finiture Finishings Ripiano in vetro trasparente con telaio in metallo verniciato: bronzo epox M421 sand epox M455
Melamine 6 types with metal painted details: bronze epox M421 sand epox M455	Glass shelf with frame in metal painted: bronze epox M421 sand epox M455

Nota
Note
In presenza di fianco interno telaio o fianco esterno vetro, considerare uno o due traversi di supporto

Where an internal frame side or external side in glass is present, consider using one or two support traverses



Vassoio portascarpe estraibile
Vassoio portascarpe estraibile, disponibile in melaminico 6 varianti con profili ferma tacco in metallo verniciato epox bronzo o sand

Extractable shoe rack
Extractable shoe rack, available in a choice of 6 variants of melamine with heel stop in sand or bronze epox painted metal



Ripiano portascarpe fisso in vetro
Ripiano portascarpe in vetro trasparente, con telaio in metallo verniciato epox bronzo o sand. Disponibile per vani in larghezza mm. 889, 981, 1165

Shoe rack in glass
Glass shoe rack with frame in sand or bronze epox painted metal. Available for elements of widths 35", 38½", 45¾"

Scarpiera — Shoe racks

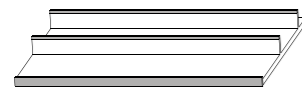

03

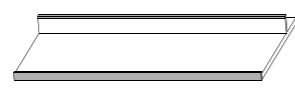

04

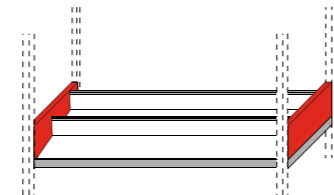

05

03 - 04

Ripiano inclinato portascarpe fisso in legno
Wooden tilted fixed shoe rack shelf

Larghezza
Width
432 - 478 - 570 - 707 - 889 - 981 - 1165
17" - 18¾" - 22½" - 27¾" - 35" - 38½" - 45¾"

Spessore
Thickness
35 - 1½"

Profondità
Depth
402 - 500
15¾" - 19¾"

Finiture
Finishings
Melaminico 6 varianti con dettagli in metallo verniciato:
bronzo epox M421
sand epox M455

Melamine 6 types with metal painted details:
bronzo epox M421
sand epox M455

05

Ripiano inclinato portascarpe fisso in legno per fianco telaio
Wooden tilted fixed shoe rack shelf for frame side

In presenza di fianco telaio è prevista l'aggiunta di 2 spondine laterali in melaminico. Dimensioni e finiture come scarpiera inclinata fissa in legno
Non disponibile per profondità 442

In the presence of a frame side, two side profiles in melamine are added. Dimensions and finishings as per the fixed inclined shoe cabinet in wood
Not available for depth 442

Nota
Note

In presenza di fianco interno telaio o fianco esterno vetro, considerare uno o due traversi di supporto

Where an internal frame side or external side in glass is present, consider using one or two support traverses



Ripiano portascarpe fisso in legno
Ripiano inclinato portascarpe fisso per fianco in melaminico da 586

Wooden tilted fixed shoe rack shelf
Fixed inclined shoe shelf in wood for side panel 586



Ripiano portascarpe fisso in legno
Ripiano inclinato portascarpe fisso per fianco in melaminico da 442

Wooden tilted fixed shoe rack shelf
Fixed inclined shoe shelf in wood for side panel 442



Ripiano portascarpe fisso in legno per fianco telaio
Ripiano inclinato fisso in legno per fianco telaio, completo di alzatine laterali in melaminico e traversi di supporto

Wooden tilted fixed shoe rack shelf for frame side
Fixed inclined shoe shelf in wood for frame side, featuring lateral upstands in melamine and support traverses

Capienza scarpiera — Capacity shoe rack

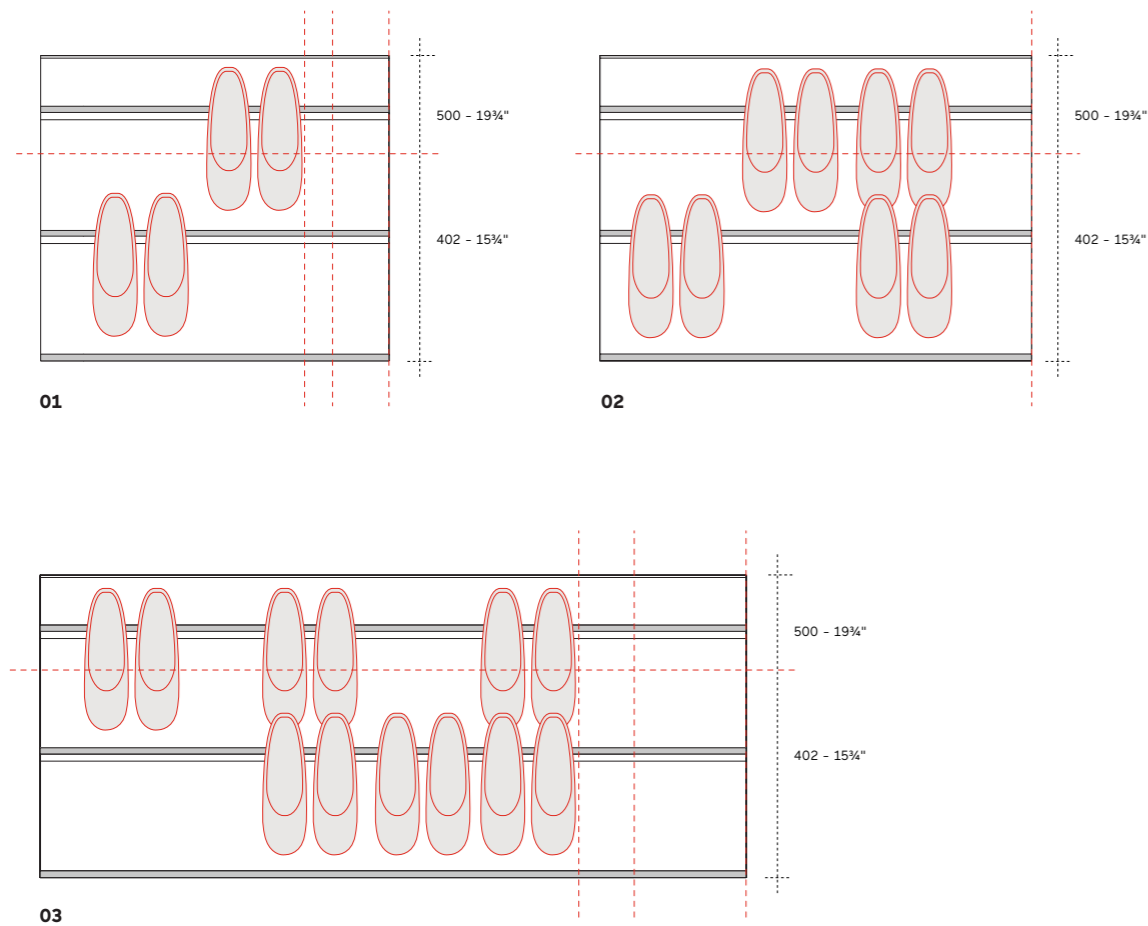

01	02	03
Larghezza scarpiera Shoes rack width 432 - 478 - 570 17" - 18 3/4" - 22 1/2"	Larghezza scarpiera Shoes rack width 707 27 3/4"	Larghezza scarpiera Shoes rack width 889 - 981 - 1165 35" - 38 1/2" - 45 1/4"
Capienza per profondità 500 Capacity for depth 19 1/4" Da 3 a 4 paia di scarpe From 3 to 4 pairs of shoes	Capienza per profondità 500 Capacity for depth 19 1/4" Da 5 a 6 paia di scarpe From 5 to 6 pairs of shoes	Capienza per profondità 500 Capacity for depth 19 1/4" Da 7 a 10 paia di scarpe From 7 to 10 pairs of shoes
Capienza per profondità 402 Capacity for depth 15 1/4" 2 paia di scarpe 2 pairs of shoes	Capienza per profondità 402 Capacity for depth 15 1/4" 3 paia di scarpe 3 pairs of shoes	Capienza per profondità 402 Capacity for depth 15 1/4" Da 4 a 5 paia di scarpe From 4 to 5 pairs of shoes

Sezione scarpiera — Shoe rack section

Vassoio portascarpe estraibile
Extractable shoe rack

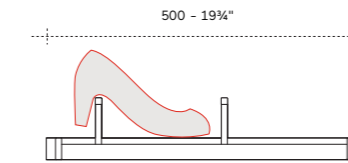

Ripiano portascarpe fisso in vetro
Shoe rack in glass

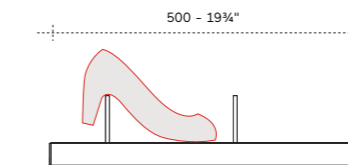

Ripiano portascarpe fisso in legno
Tilted shoe rack in melamine

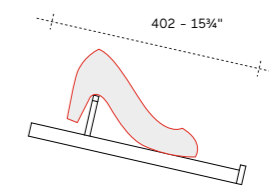
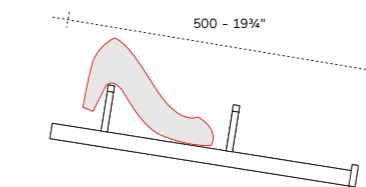

Nota
Note
Le quantità indicate sono variabili a seconda della tipologia di scarpa. In presenza di fianco interno telaio o fianco esterno vetro, considerare uno o due traversi di supporto.

Where an internal frame side or external side in glass is present, consider using one or two support traverses. The quantities will vary in relation to the type of shoe.

Appenderie — Hanging bars

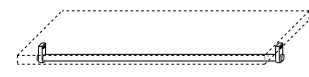

01

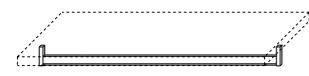
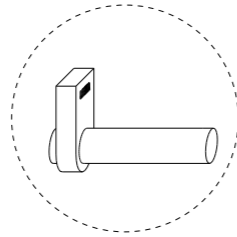
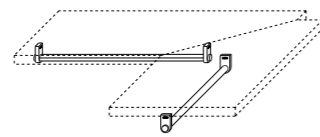

02

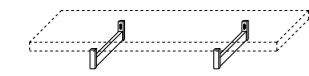
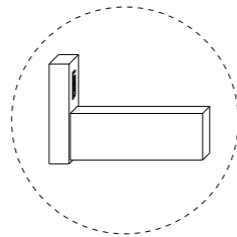
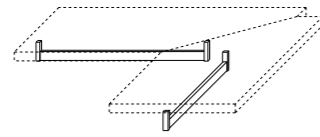

03

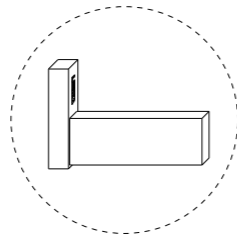
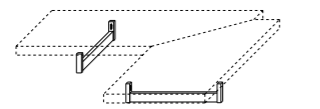

01
Barra appendiabiti
sezione tonda
Hanging bar round
section

**Dimensione per ripiano
lineare**
Linear shelf dimension
432 - 478 - 570 - 707 -
889 - 981 - 1165
17" - 18¾" - 22½" -
27¾" - 35" - 38½" -
45¾"

**Dimensione per ripiano
angolare legno**
Corner melamine shelf
dimension
667 x 667
26¼" x 26¼"

02
Barra appendiabiti
sezione rettangolare
Hanging bar rectangular
section

**Dimensione per colonne
singole e doppie**
Double and single
column dimensions
432 - 478 - 570 - 707 -
889 - 981 - 1165
17" - 18¾" - 22½" -
27¾" - 35" - 38½" -
45¾"

**Dimensione per ripiano
angolare legno**
Dimensions for corner
melamine shelf
667 x 667
26¼" x 26¼"

**Dimensione per ripiano
angolare vetro/pelle
sintetica**
Dimensions for corner
glass/synthetic
leather shelf
784 x 784
30¾" x 30¾"

**Dimensione per ripiano
angolare vetro/pelle
sintetica per fianco
telaio**
Dimensions for corner
glass/synthetic
leather shelf for frame
side panel
774 x 774
30½" x 30½"

03
Barra appendiabiti
sezione rettangolare
per profondità fianco 442
Hanging bar rectangular
section for side 17½"

**Dimensione per ripiano
lineare e angolare**
Linear and corner shelf
dimension
402 - 15¾"

**Finiture
Finishing**
Metallo verniciato:
bronzo epox M421
sand epox M455

Metal painted:
bronze epox M421
sand epox M455



**Barra appendiabiti
sezione tonda**
Predisposta per fissaggio
su ripiani e coperchi.
Disponibile per tutte
le larghezze di vano.
**Finitura in metallo
verniciato sand epox
M455**

**Hanging bar round
section**
Designed to attach
to shelves and tops.
Available for all element
widths.
**Chromed metal finishing
M455**



**Barra appendiabiti
sezione tonda**
Predisposta per
fissaggio su ripiani
e coperchi. Disponibile
per tutte le larghezze
di vano.
**Finitura in metallo
verniciato bronzo epox
M421**

**Hanging bar round
section**
Designed to attach
to shelves and tops.
Available for all element
widths.
**Sand epox painted metal
finishing M421**



**Barra appendiabiti
sezione rettangolare**
Predisposta per
fissaggio su ripiani
e coperchi. Disponibile
per tutte le larghezze
di vano.
**Finitura in metallo
verniciato sand epox
M455**

**Hanging bar rectangular
section**
Designed to attach
to shelves and tops.
Available for all element
widths.
**Chromed metal finishing
M455**



**Barra appendiabiti
sezione rettangolare**
Predisposta per
fissaggio su ripiani
e coperchi. Disponibile
per tutte le larghezze
di vano.
**Finitura in metallo
verniciato bronzo epox
M421**

**Hanging bar rectangular
section**
Designed to attach
to shelves and tops.
Available for all element
widths.
**Bronze epox painted
metal finishing M421**



**Barra appendiabiti
sezione rettangolare
per fianco 442**
Predisposta per
fissaggio su ripiani
e coperchi.
Disponibile per tutte
le larghezze di vano.
**Finitura in metallo
verniciato bronzo M421
o sand epox M455**

**Hanging bar rectangular
section**
Designed to attach
to shelves and tops.
Available for all element
widths.
**Bronze epox painted
metal finishing M421
or sand epox painted
metal finishing M455**

Appenderie — Hanging bars

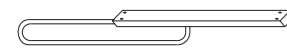

04

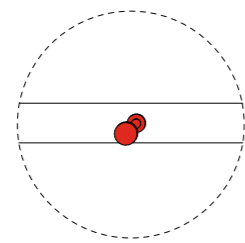

05

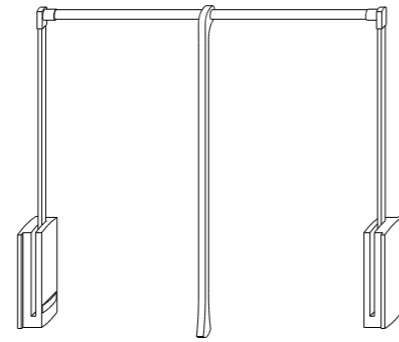

06

04

Portabiti estraibile
Extractable hanging bar
Predisposto per fissaggio sotto ripiano, ideale per armadio ridotto in profondità.

Designed to be attached under the shelf
Ideal for wardrobe with a shallow depth

Profondità
Depth
da 400 a 585
from 15½" to 23"

Finiture
Finishings
Metallo cromato
Chromed metal

05

Tiretto appendiabiti
Extractable clothes pin
Estrazione manuale. Installato al centro dello spessore del ripiano. Non disponibile per ripiano Tech e Tech con luce

Manual extraction.
Installed in the centre of the shelf thickness.
Not available for Tech or Tech with light shelves

Finiture
Finishings
Metallo verniciato: bronzo epox M421
sand epox M455

Metal painted:
bronze epox M421
sand epox M455

06

Servetto
Pull down hanging bar
Fissaggio ai fianchi in legno dell'armadio.

Fixed to the wooden sides of the wardrobe

Larghezza
Width
da 440 a 610
da 600 a 1000
da 770 a 1200
from 17¼" to 24"
from 23½" to 39¼"
from 30¼" to 47¼"

Altezza
Height
960 - 37¼"

Finiture
Finishings
Metallo verniciato: bronzo epox M421
sand epox M455

Metal painted:
bronze epox M421
sand epox M455



Portabiti estraibile
Portabiti estraibile, ideale per armadio ridotto in profondità. Predisposto per fissaggio su ripiano. Disponibile in metallo cromato

Extractable hanging bar
Extractable clothes hanger, ideal for wardrobes with a shallow depth. Designed to be attached to the shelf. Available in chromed metal



Tiretto appendiabiti
Accessorio appendiabiti estraibile. Posizionato al centro dello spessore dei ripiani. Finiture disponibili in metallo verniciato epox bronzo o sand

Extractable clothes pin
Clothes hanger accessory with pull-out opening. Positioned at the center of the shelf thickness. Finishings available in sand or bronze epox painted metal

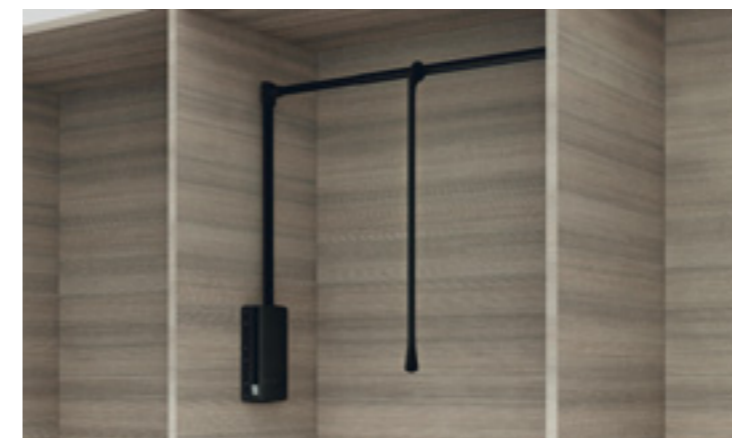

Servetto
Accessorio appendiabiti saliscendi, fissato ai fianchi dell'armadio. Disponibile per le larghezze di vano da mm. 570, 707, 889, 981, 1165. Finiture disponibili metallo verniciato color bronzo o sand

Pull down hanging bar
Riser rail clothes hanger accessory, attached to the sides of the wardrobe. Available for element widths 22½", 27¾", 35", 38½", 45¾".
Finishings available in grey or bronze

Appenderie — Hanging bars

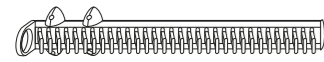

07

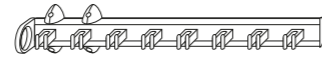

08

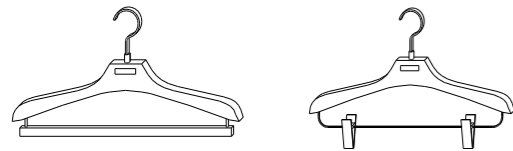

09



10

07

Elemento portacravatte estraibile
Extractable tie-rack
Predisposto per fissaggio su fianco in legno.

Designed to be attached on the wood side

Dimensioni (L x P)
Dimension (W x D)
505 x 85
20" x 3 1/4"

Capacità
Capacity
Nr. cravatte 32
Nbr. 32 ties

Finiture
Finishings
Alluminio color grigio
Alluminio color bronzo

Aluminum color grey
Aluminum color bronze

08

Elemento portacinture estraibile
Extractable belt-hanger
Predisposto per fissaggio su fianco in legno

Designed to be attached to the side

Dimensioni (L x P)
Dimension (W x D)
505 x 85
20" x 3 1/4"

Capacità
Capacity
Nr. cinture 8
Nbr. 8 belts

Finiture
Finishings
Alluminio color grigio
Alluminio color bronzo

Aluminum color grey
Aluminum color bronze

09

Gruccia appendiabiti
Clothes hanger
Per abiti uomo e portapantaloni
Per abiti donna e portagonne

For men's clothes and trouser-hangers
For women's clothes and skirt-hangers

Finiture
Finishings
Faggio tinto grigio con logo LEMA.
Dettagli in metallo verniciato bronzo epox M421

Grey stained beech with LEMA logo.
Details in bronze epox painted metal M421

Aluminum color grey
Aluminum color bronze

10

Asta prendiabiti
Clothes hook

Altezza
Height
1150 - 45 1/4"

Finiture
Finishings
Metallo cromato e dettagli in plastica nera

Chrome-plated metal and detailing in black plastic



Portacravatte estraibile
Portacravatte estraibile, installato su fianco interno legno dell'armadio. Capacità: 32 cravatte. Finiture disponibili color grigio o bronzo

Extractable tie-rack
Extractable tie-rack, installed on the interior side of the wardrobe, ideal for wardrobes with a shallow depth. Capacity: 32 ties. Finishings available in grey or bronze



Portacinture estraibile
Portacinture estraibile, installato su fianco interno legno dell'armadio. Capacità: 8 cinture. Finiture disponibili color grigio o bronzo

Extractable belt-hanger
Extractable belt-hanger, attached to the interior side of the wardrobe, ideal for wardrobe with a shallow depth. Capacity: 8 belts. Finishings available in grey or bronze



Gruccia appendiabiti
Disponibile in faggio tinto grigio con logo LEMA. Dettagli in metallo verniciato bronzo epox

Trousers and skirts hanger
Available in grey stained beech and LEMA logo. Details in bronze epox painted metal



Asta prendiabiti
Bastone prendiabiti disponibile in metallo cromato e dettagli in plastica nera

Clothes hook
Garment reach pole available in chromed metal

Vassoi ed accessori — Trays and accessories

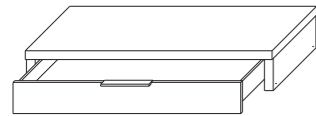

01

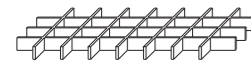

02



03

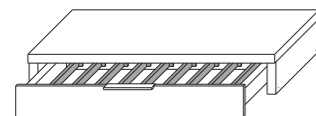

04

01	02	03	04
Vassoio estraibile Tech extractable tray	Griglia accessori per vassoio - Opzionale Grid accessories for tray - Opzionale	Tappetino interno per vassoio - Opzionale Pad for drawer interiors - Opzionale	Portapantaloni estraibile Extractable trousers hanger
Larghezza Width 889 - 981 - 1165 35" - 38½" - 45¾"	Larghezza Width Per colonna da 889 - 981 - 1165 For column width 35" - 38½" - 45¾"	Larghezza Width Per colonna da 889 - 981 - 1165 For column width 35" - 38½" - 45¾"	Larghezza Width 889 - 981 - 1165 35" - 38½" - 45¾"
Altezza Height 163 - 6½"	Altezza Height 50 - 2"	Altezza Height 163 - 6½"	Altezza Height 163 - 6½"
Profondità Depth 500 - 19¾"	Profondità Depth 500 - 19¾"	Profondità Depth 500 - 19¾"	Profondità Depth 500 - 19¾"
Finiture Finishings Melaminico 6 varianti Melamine 6 types	Capienza Capacity Vedi pag. 202 On p. 202 Finiture Finishings Melaminico 6 varianti Melamine 6 types	Finiture Finishings Pelle sintetica color moka Synthetic leather moka colour	Finiture Finishings Melaminico 6 varianti. Aste di supporto in metallo verniciato bronzo epox M421 o sand epox M455 Melamine 6 variants. Metal supports painted bronze epox M421 or sand epox M455
Capienza portapantaloni Capacity trousers hanger			Larghezza vassoio Tray width 889 - 35" 981 - 38½" 1165 - 45¾"
			Nr. pantaloni Trousers nbr. 8 9 11



Vassoio estraibile
Comfort - Tech
 Vassoio estraibile con griglia porta oggetti, disponibile in melaminico 6 varianti, maniglia in metallo verniciato epox bronzo o sand. La versione Tech si arricchisce con l'aggiunta di profili laterali in metallo, finitura in coordinato alla maniglia

Comfort - Tech
extractable tray
 Extractable tray with grid compartments for small items in a choice of 6 variants of melamine, handle in sand or bronze epox painted metal. Tech version is enhanced with the addition of metal side profiles, finishings to match handle



Portapantaloni estraibile
Comfort - Tech
 Portapantaloni estraibile con struttura in melaminico 6 varianti, aste di supporto e maniglia in metallo verniciato epox bronzo e sand. La versione Tech si arricchisce con l'aggiunta di profili laterali in metallo, finitura in coordinato alla maniglia

Comfort - Tech
extractable trousers hanger
 Extractable trousers hanger with structure in a choice of 6 types of melamine, support rods and handle in sand or bronze epox painted metal. Tech version is enhanced with the addition of side profiles in metal, finishing to match handle

Nota
Note
 In presenza di fianco interno telaio o fianco esterno vetro, considerare uno o due traversi di supporto

 In the presence of internal frame side or external side in glass, consider using one or two support traverses

Vassoi ed accessori — Trays and accessories

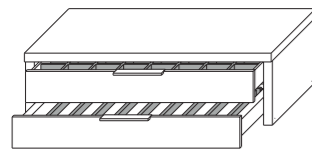

05

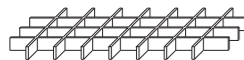

06



07

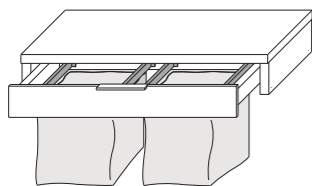

08



Vassoio doppio estraibile Comfort – Tech
Vassoio doppio con portapantaloni e cassetto con griglia accessori, disponibile in melaminico 6 varianti, aste di supporto e maniglie in metallo verniciato epox bronzo o sand. La versione Tech si arricchisce con l'aggiunta di profili laterali in metallo, finitura in coordinato alla maniglia

Comfort – Tech double pull-out tray
Double tray with trousers hanger and drawer with accessories grid, available in a choice of 6 types of melamine, support rods and handle in sand or bronze epox painted metal. Tech version is enhanced with the addition of side profiles in metal, finishings to match handle



Portabiancheria estraibile Comfort – Tech
Portabiancheria estraibile con struttura in melaminico 6 varianti, sacche in tessuto grigio trapuntato, maniglia in metallo verniciato epox bronzo o sand. La versione Tech si arricchisce con l'aggiunta di profili laterali in metallo, finitura in coordinato alla maniglia

Comfort – Tech extractable laundry basket
Extractable laundry basket with structure in a choice of 6 types of melamine, bags in grey quilted fabric, handle in sand or bronze epox painted metal. Tech version is enhanced with the addition of side profiles in metal, finishing to match handle

05	06	07	08								
<p>Vassoio doppio – Elemento con vassoio e portapantaloni estraibile Double tray – Elemento con vassoio e portapantaloni estraibile</p> <p>Larghezza Width 889 - 981 - 1165 35" - 38½" - 45¾"</p> <p>Altezza Height 291 - 11½"</p> <p>Profondità Depth 500 - 19¾"</p> <p>Finiture Finishings Melaminico 6 varianti Melamine 6 types</p>	<p>Griglia accessori – Opzionale Grid accessories – Optional</p> <p>Larghezza Width Per colonna da 889 - 981 - 1165 For column width 35" - 38½" - 45¾"</p> <p>Altezza Height 50 - 2"</p> <p>Capienza Capacity Vedi pag. 204 On p. 204</p> <p>Finiture Finishings Melaminico 6 varianti Melamine 6 types</p>	<p>Capienza portapantaloni Capacity trousers hanger</p> <table border="1"> <thead> <tr> <th>Larghezza vassoio</th> <th>Nr. pantaloni</th> </tr> </thead> <tbody> <tr> <td>889 - 35"</td> <td>8</td> </tr> <tr> <td>981 - 38½"</td> <td>9</td> </tr> <tr> <td>1165 - 45¾"</td> <td>11</td> </tr> </tbody> </table> <p>Tappetino interno per vassoio – Opzionale Pad for drawer interiors – Opzionale</p> <p>Larghezza Width Per colonna da 889 - 981 - 1165 For column width 35" - 38½" - 45¾"</p> <p>Finiture Finishings Pelle sintetica color moka Synthetic leather moka colour</p>	Larghezza vassoio	Nr. pantaloni	889 - 35"	8	981 - 38½"	9	1165 - 45¾"	11	<p>Portabiancheria estraibile Extractable laundry basket</p> <p>Larghezza Width 889 - 981 - 1165 35" - 38½" - 45¾"</p> <p>Altezza Height 163 - 6½"</p> <p>Profondità Depth 500 - 19¾"</p> <p>Finiture Finishings Melaminico 6 varianti con sacche in tessuto grigio trapuntato 6 types of melamine with grey quilted fabric bags</p>
Larghezza vassoio	Nr. pantaloni										
889 - 35"	8										
981 - 38½"	9										
1165 - 45¾"	11										

Nota Note
In presenza di fianco interno telaio o fianco esterno vetro, considerare uno o due traversi di supporto
Where an internal frame side or external side in glass is present, consider using one or two support traverses

Teca ed accessori — Case and accessories

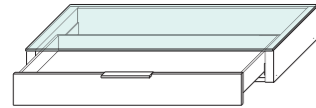

01

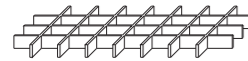

02



03

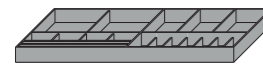

04

01	02	03	04
<p>Teca con vassoio estraibile Case with extractable tray</p> <p>Larghezza Width 889 - 981 - 1165 35" - 38½" - 45¾"</p> <p>Altezza Height 136 - 5¼"</p> <p>Profondità Depth 500 - 19¾"</p>	<p>Finiture Finishings Melaminico 6 varianti Top in vetro trasparente con perimetro serigrafato color bronzo M421 o sand M455</p> <p>Melamine 6 types Top in transparent glass with sand or bronze colored serigraphed perimeter</p>	<p>Griglia accessori per teca - Opzionale Grid accessories for case - Opzionale</p> <p>Larghezza Width Per colonna da 889 - 981 - 1165</p> <p>For column width 35" - 38½" - 45¾"</p> <p>Altezza Height 50 - 2"</p> <p>Capienza Capacity Vedi pag. 204 On p. 204</p> <p>Finiture Finishings Melaminico 6 varianti Melamine 6 types</p>	<p>Tappetino interno per teca - Opzionale Pad for case interiors - Opzionale</p> <p>Larghezza Width Per colonna da 889 - 981 - 1165</p> <p>For column width 35" - 38½" - 45¾"</p> <p>Finiture Finishings Pelle sintetica color moka</p> <p>Synthetic leather moka colour</p>
			<p>Portagioielli per teca Jewelry insert for case</p> <p>Larghezza Width Per colonna da 889 - 981 - 1165</p> <p>For column width 35" - 38½" - 45¾"</p> <p>Altezza Height 60 - 2¼"</p> <p>Capienza Capacity Vedi pag. 205 On p. 205</p> <p>Finiture Finishings Pelle sintetica color moka</p> <p>Synthetic leather moka colour</p>



Teca estraibile Comfort - Tech
Teca estraibile con griglia porta oggetti. Struttura in melaminico 6 varianti, maniglia in metallo verniciato epox bronzo o sand, top in vetro trasparente con perimetro serigrafato color bronzo o sand. La versione Tech si arricchisce con l'aggiunta di profili laterali in metallo, finitura in coordinato alla maniglia

Comfort - Tech extractable case
Extractable case with grid compartments for small items in a choice of 6 variants of melamine, handle in sand or bronze epox painted metal, top in transparent glass with sand or bronze colored serigraphed perimeter. Tech version is enhanced with the addition of side profiles in metal, finishings to match handle



Teca estraibile Comfort - Tech
Teca estraibile con griglia porta gioielli in pelle sintetica color moka. Struttura in melaminico 6 varianti, maniglia in metallo verniciato epox bronzo o sand, top in vetro trasparente con perimetro serigrafato color bronzo o sand. La versione Tech si arricchisce con l'aggiunta di profili laterali in metallo, finitura in coordinato alla maniglia

Comfort - Tech extractable case
Extractable case with grid compartments for jewels in moka eco-leather. Structure in a choice of 6 variants of melamine, handle in sand or bronze epox painted metal, top in transparent glass with sand or bronze colored serigraphed perimeter. Tech version is enhanced with the addition of side profiles in metal, finishings to match handle

Nota
Note
In presenza di fianco interno telaio o fianco esterno vetro, considerare uno o due traversi di supporto

In presenza di fianco interno telaio o fianco esterno vetro, considerare uno o due traversi di supporto

Capienza griglia accessori — Accessories grid capacity

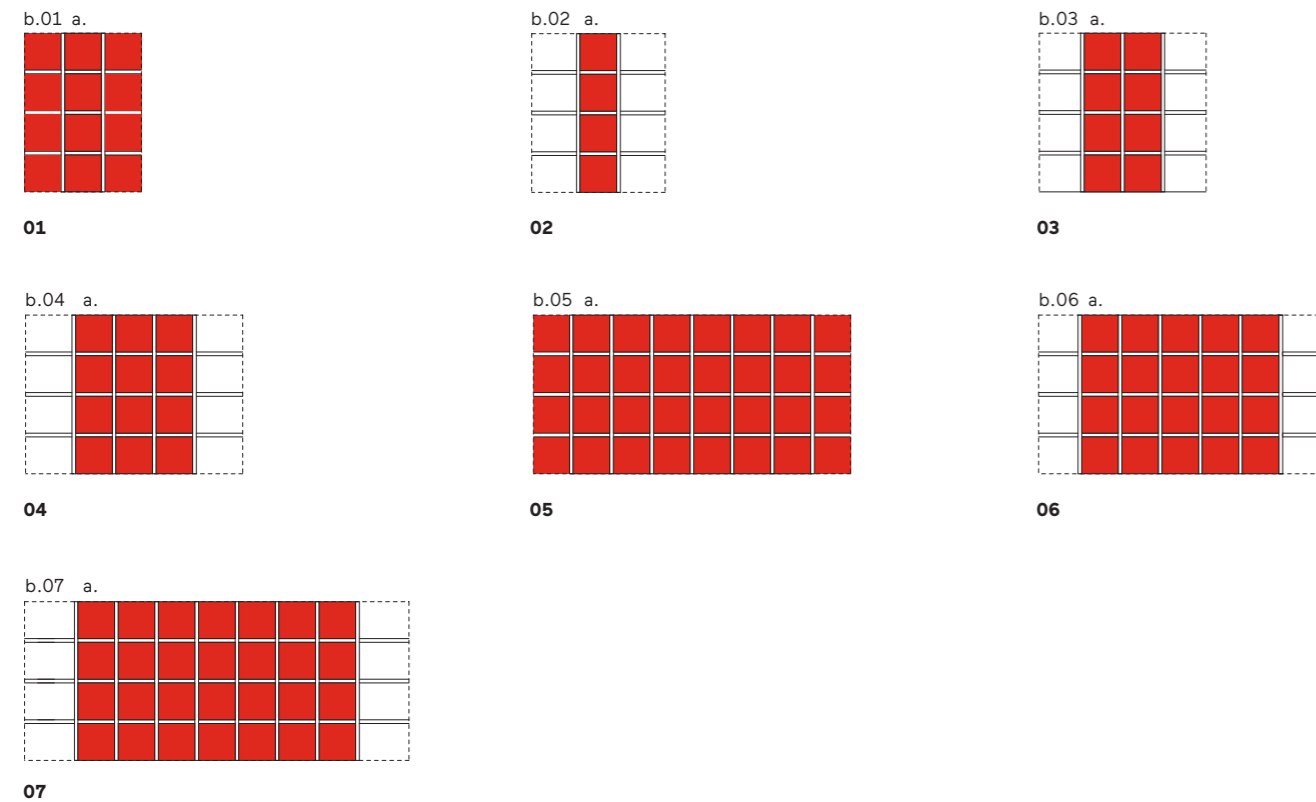

01

Griglia accessori per cassetto, vassoio estraibile e teca
Accessories grid for drawer, extractable tray and case

Larghezza
Width

Per colonna da
 For column width
 01 432 - 17"
 02 478 - 18¾"
 03 570 - 22½"
 04 707 - 27¾"
 05 889 - 35"
 06 981 - 38½"
 07 1165 - 45¾"

Altezza
Height

65 per cassetto
 50 per vassoio e teca

2½" for drawer
 2" for tray and case

Finiture
Finishings

Melaminico 6 varianti
 (melaminico stone
 solo per griglia cassette)
 Melamine 6 types
 (stone melamine
 for drawers grid only)

Dimensione scomparti
Compartment dimensions

Legenda

a. 100×100 - 4"×4"
 b.01 100×100 - 4"×4"
 b.02 123×100 - 4¾"×4"
 b.03 114×100 - 4½"×4"
 b.04 127×100 - 5"×4"
 b.05 100×100 - 4"×4"
 b.06 108×100 - 4¾"×4"
 b.07 136×100 - 5¼"×4"

Capienza portagioielli — Jewelry insert capacity

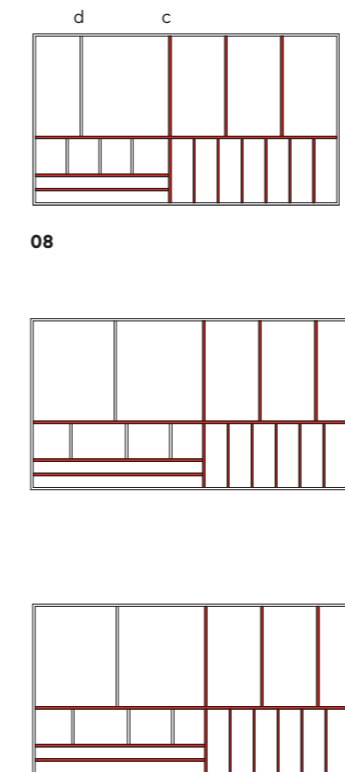

08

Griglia portagioielli per teca Comfort - Tech
Jewelry holder for case Comfort - Tech

Larghezza
Width

Per colonna da
 889 - 981 - 1165

For column width
 35" - 38½" - 45¾"

Altezza
Height

60 - 2¼"

Finiture
Finishings

Pelle sintetica color
 moka

Synthetic leather moka
 colour

c.

Divisori fissi
 Fixed partitions

d.

Divisori spostabili
 Moveable partitions

Porta gioielli modulare — Accessories grid capacity

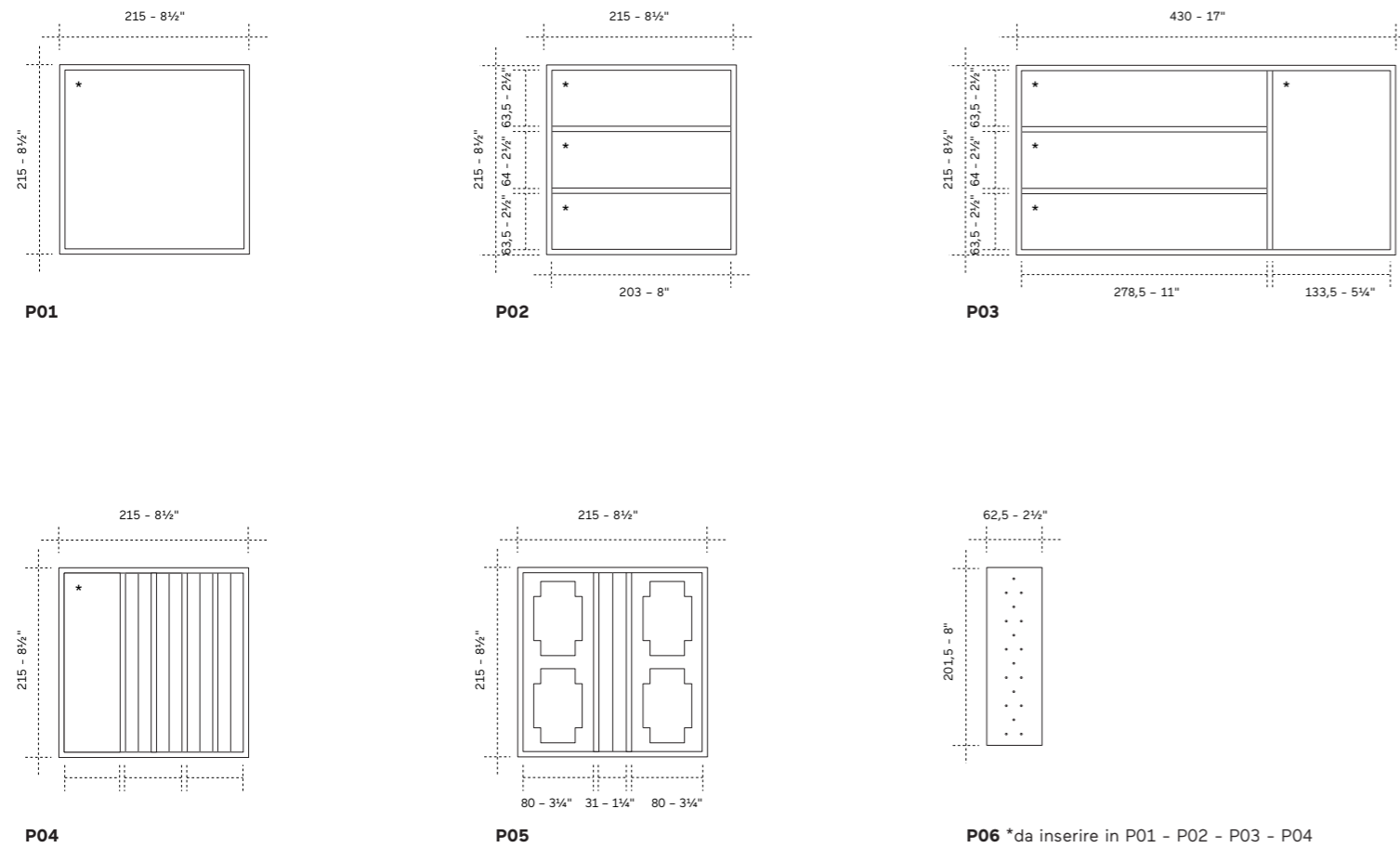

P01 P02 P03 P04 P05 P06 *da inserire in P01 - P02 - P03 - P04

Moduli porta gioielli per cassetti, vassoi e teche Jewellery holders for shelves, trays and display cases

P01 Portagioielli/ Svuotatasche	P01 Jewellery holder/ Container for small objects
P02 Portagioielli/ Svuotatasche	P02 Jewellery holder/ Container for small objects
P03 Portagioielli/ Svuotatasche	P03 Jewellery holder/ Container for small objects
P04 Porta anelli	P04 Ring holder
P05 Portaorologi/bracciali	P05 Watch/bracelet holder
P06 Portaorecchini	P06 Earring holder

P01 - P02 - P04 - P05

**Larghezza
Width**
215 - 8½"

**Profondità
Depth**
215 - 8½"

**Altezza
Height**
60 - 2¼"

**Finiture
Finishing**
Pelle sintetica
color moka

Synthetic leather
moka colour

P03

**Larghezza
Width**
430 - 17"

**Profondità
Depth**
215 - 8½"

**Altezza
Height**
60 - 2¼"

**Finiture
Finishing**
Pelle sintetica
color moka

Synthetic leather
moka colour

P06

**Larghezza
Width**
62,5 - 2½"

**Profondità
Depth**
201,5 - 8"

**Altezza
Height**
60 - 2¼"

**Finiture
Finishing**
Pelle sintetica
color moka

Synthetic leather
moka colour



01

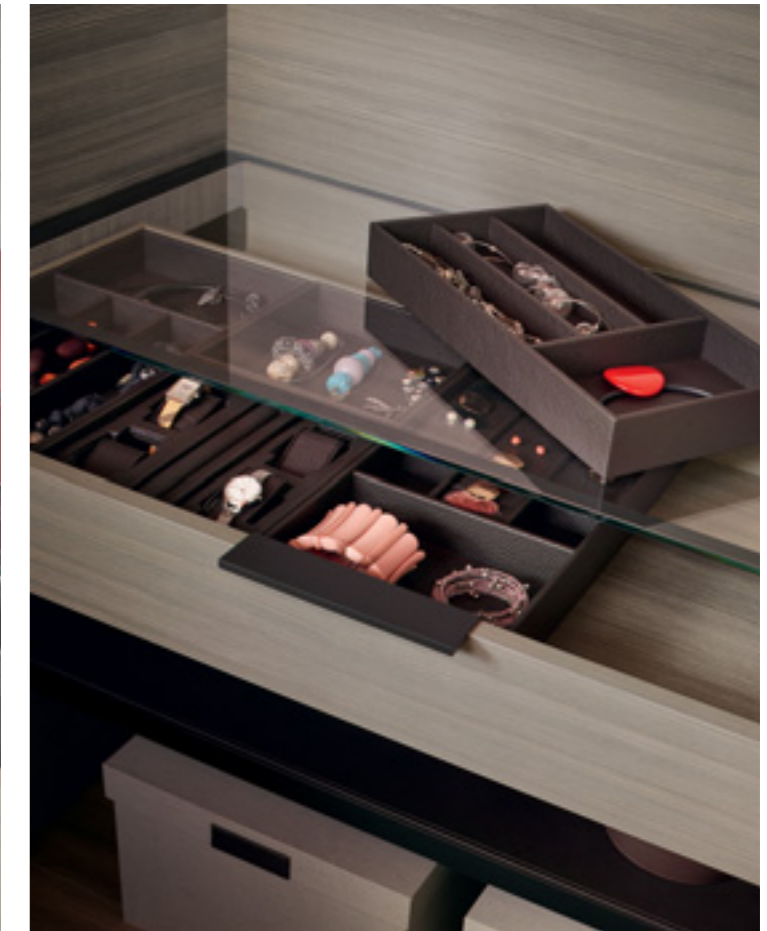

01

Esempio Example

Divisione cassetto
realizzata con i moduli:
P01 - P03 - P05 - P06

Drawer layout with
modules:
P01 - P03 - P05 - P06

Griglia portacamicie — Shirts rack

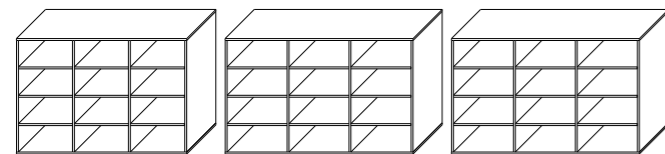

01

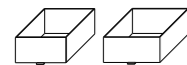

02

01

Griglia portacamicie Shirts holder

In appoggio su ripiani e cassettiere

Resting on top of shelves and drawer units

Larghezza

Width

Per colonna da
889 - 981 - 1165

For column width
35" - 38½" - 45¾"

Altezza

Height

600 - 23½"

Profondità

Depth

430 - 17"

Finiture

Finishings

Melaminico 6 varianti
Melamine 6 types

02

Scatole per griglia portacamicie Boxes for shirts holder

Larghezza
Width
264 - 295
10½" - 11½"

Altezza
Height
132 - 23½"

Profondità
Depth
425 - 16¾"

Finiture

Finishings

Struttura in tessuto con frontale in pelle sintetica color moka

Structure lined in fabric with front in synthetic leather moka colour

Capienza Capacity

Larghezza griglia
Grid width

889 - 35"
981 - 38½"
1165 - 45¾"

Dimensione scatola
Boxes dim.

264 - 10½"
295 - 11½"
264 - 10½"

Nr. scatole
Boxes nbr.

12
12
12



Griglia portacamicie
Contentitore portacamicie in appoggio su ripiani o cassettiere. Struttura disponibile in melaminico 6 varianti, per vani in larghezza mm. 889, 981, 1165

Shirts rack
Shirts holder placed on shelves or drawer units. Structure available in 6 types of melamine, for elements widths 35", 38½", 45¾"



Scatole per griglia portacamicie (opzionali)
Scatole rivestite in tessuto e frontale in pelle sintetica color moka. Disponibile nelle larghezze mm. 264, 295

Boxes for shirts holder (optional)
Lined boxes in fabric with front in synthetic leather moka colour. Available in widths 10½", 11½"

Accessori — Accessories



01

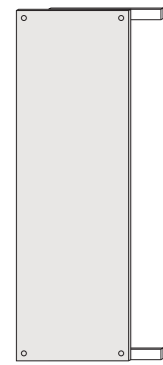

02

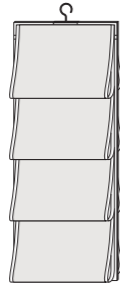

03

01

Specchio per armadio battente
Mirror for hinged door wardrobe
Specchio fissato sul lato interno delle ante
Non disponibile per anta Nur e Dandy

Mirror fixed to interior side of the doors
Not available for doors Nur and Dandy

Larghezza Width
350 - 13¾"

Altezza Height
1500 - 59"

02

Specchio per armadio scorrevole e coplanare
Mirror for sliding and coplanar wardrobe doors
Specchio estraibile e girevole, fissato sul lato interno dei fianchi in legno dell'armadio

Extractable and rotating mirror fixed on interior wooden sides of wardrobe

Larghezza Width
450 - 17½"

Altezza Height
1400 - 55"

03

Portaborse bifacciale
Two-face bag holder

Larghezza Width
400 - 15¾"

Altezza Height
1000 - 39¾"

Capacità Capacity
Nr.4 borse media dimensione
Nr.8 borse piccola dimensione

Nbr.4 medium sized bags
Nbr.8 small sized bags

Finiture portaborse
Bag holder finishings

Pannelli di sostegno rivestiti in tessuto microfibra.
Porta borse in tulle con bordo in pelle sintetica color moka

Supporting panels lined in microfiber.
Bag holder in tulle hemmed in synthetic leather moka colour

Nota Note

In presenza di maniglie con avvitamento sul lato interno dell'anta, è consigliabile installare le maniglie scelte con orientamento orizzontale

In the presence of handles which twist towards the internal side of the door, we recommend fitting horizontal handles



Specchio per armadio battente
Mirror for hinged door wardrobe
Specchio installato su lato interno delle ante battenti. Dimensioni mm. 350 x 1500. Non utilizzabile su anta Nur e Dandy

Mirror fixed to interior side of hinged doors. Dimensions 13¾" x 59". Cannot be used on Nur or Dandy doors



Specchio per armadio scorrevole
Mirror for sliding doors wardrobe
Specchio estraibile e girevole applicato sui fianchi interni dell'armadio. Predisposto con telaio in metallo verniciato alluminio M405

Extractable and rotating mirror fixed to end or intermediate interior sides of the wardrobe. With aluminium painted metal frame M405



Portaborse bifacciale
Two-face bag holder

Predisposto con gancio per essere appeso all'interno dell'armadio. Composto da 8 vani ad asola fissati con clips, con possibilità di sgancio per borse di media misura

Provided with hook to hang inside the wardrobe. Composed of 8 pockets fixed with clips, with the possibility to unfasten for medium-sized bags

Accessori — Accessories

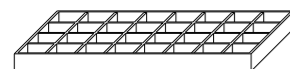

04



05

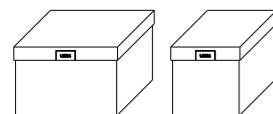

06

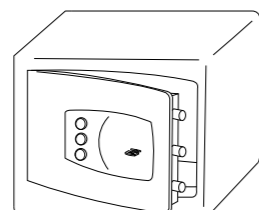

07

<p>04</p> <p>Griglia portaoggetti Tie / belt-holder element In appoggio su ripiano o cassettiere To be laid on shelf or chest of drawers</p> <p>Larghezza Width Per colonna da 889 - 981 - 1165</p> <p>For column width 35" - 38½" - 45¾"</p> <p>Dimensioni (H x P) Dimensions (H x D) 65 x 456 2½" x 18"</p> <p>Capacità Capacity Vedi pag. 204 On p. 204</p> <p>Finiture Finishings Melaminico 6 varianti Melamine 6 types</p>	<p>05</p> <p>Tappetino per griglia portaoggetti (opzionale) Pad for tie / belt holder</p> <p>Larghezza Width Per colonna da 889 - 981 - 1165</p> <p>For column width 35" - 38½" - 45¾"</p> <p>Finiture Finishings Pelle sintetica color moka</p> <p>Synthetic leather moka colour</p>	<p>06</p> <p>Scatola con coperchio Box with cover</p> <p>Larghezza Width 260 - 390 10¾" - 15¼"</p> <p>Altezza Height 260 - 10¾"</p> <p>Profondità Depth 390 - 15¼"</p>	<p>07</p> <p>Finiture Finishings MDF rivestito esternamente in tessuto grigio, internamente in tessuto tecnico nero a nido d'ape. Coperchio con inserto in pelle sintetica color moka e logo LEMA impresso</p> <p>In MDF, externally covered with grey fabric. Internally covered with black technical fabric with honeycomb texture. Top with insert in synthetic leather colour moka and embossed LEMA logo</p> <p>Cassaforte Safe Liberamente posizionabile in qualsiasi vano dell'armadio su elementi in legno</p> <p>Free set in every wardrobe columns on wood elements</p> <p>Dimensioni (L x P x H) Dimensions (W x D x H) 400 x 350 x 280 470 x 350 x 350</p> <p>Peso Weight 35,5 kg 47,5 kg</p> <p>Informazioni utili Useful information Dotata di chiave a doppia mappa + combinatore a 3 volantini. Serratura di alta sicurezza di ultima generazione, con 8 leve asimmetriche ed indipendenti, certificata UNI EN 1300. Sono inclusi: - un ripiano interno - fori di ancoraggio sulla base e sullo schienale e tasselli di fissaggio</p> <p>Equipped with double-sided key + three-valve combination. Cutting-edge, high-security lock with 8 asymmetrical, independent levers, UNI EN 1300 certified. Included: - one internal shelf - anchorage holes on the base and rear and mounting dowels</p>
---	--	---	--



Griglia portaoggetti in appoggio
Griglia portaoggetti in appoggio su cassettiere e ripiani. Realizzata in melaminico 6 varianti, disponibile per le larghezze di vano da mm. 889, 981, 1165. Tappetino opzionale in pelle sintetica color moka da inserire sul fondo

Tie-belt holder element to be laid on shelf or chest of drawers
Tie-belt rack to be laid on shelves or drawer units. Available in 6 types of melamine, for element widths 35", 38½", 45¾". Optional pad in synthetic leather moka colour for bottom



Scatole con coperchio
Scatole in MDF rivestite esternamente in tessuto grigio ed internamente da tessuto tecnico nero a nido d'ape. Coperchio con inserto in pelle sintetica color moka e logo impresso

Box with cover
MDF boxes lined outside in grey fabric and inside with a black technical honeycomb fabric. Cover with moka eco-leather insert and embossed logo



Cassaforte
Cassaforte liberamente posizionabile a discrezione del cliente in qualsiasi vano dell'armadio su elementi in legno. Disponibile in 2 dimensioni

Box with cover
MDF boxes lined outside in grey fabric and inside with a black technical honeycomb fabric. Cover with moka synthetic leather insert and embossed logo

Cassettiere — Drawer unit

Cassettiere in due versioni, Tech e Comfort, in una gamma di melaminici che spazia dall'effetto tessile di Canvas ai legni chiari o scuri per consentire un armonioso dialogo con le facciate dell'armadio. Lema consiglia l'accostamento cromatico tra melaminico e maniglie in metallo.

Drawer units in Tech or Comfort versions, available in a range of melamines including the textile-effect Canvas and light or dark wood, ensuring the best possible match for the façade of the wardrobe. Lema advises combining melamine colours with metal handles.

Struttura cassetti Chest of drawers structure

Melaminici Melamines

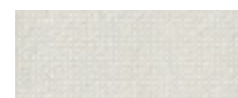

Canvas



Lino



Larice sbiancato
Bleached larch



Larice grigio
Grey larch

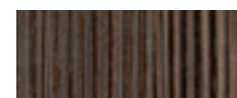

Larice moka
Moka larch



Visone

Interno cassetti Internal drawer case



Stone

Profili e maniglie Profile and handles



Metallo verniciato bronzo
epox M421 - Metal bron-
ze epox painted M42



Metallo verniciato sand
epox M455 - Metal sand
epox painted M455



Cassettiere Comfort e Tech

Comfort and Tech drawers unit

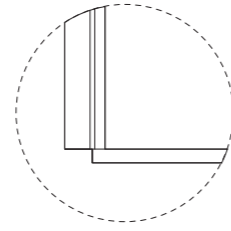
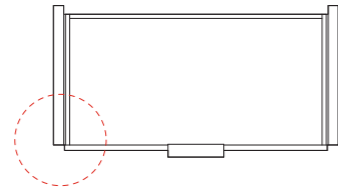
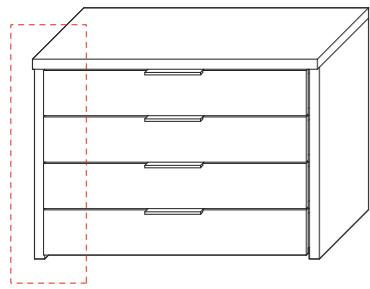

Comfort

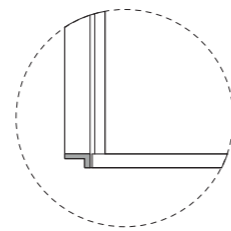
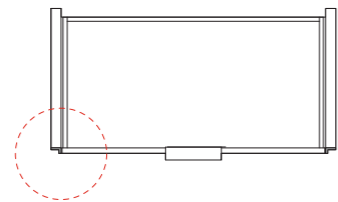
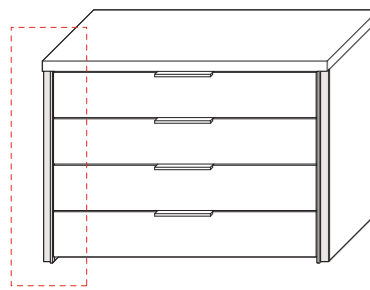

Tech

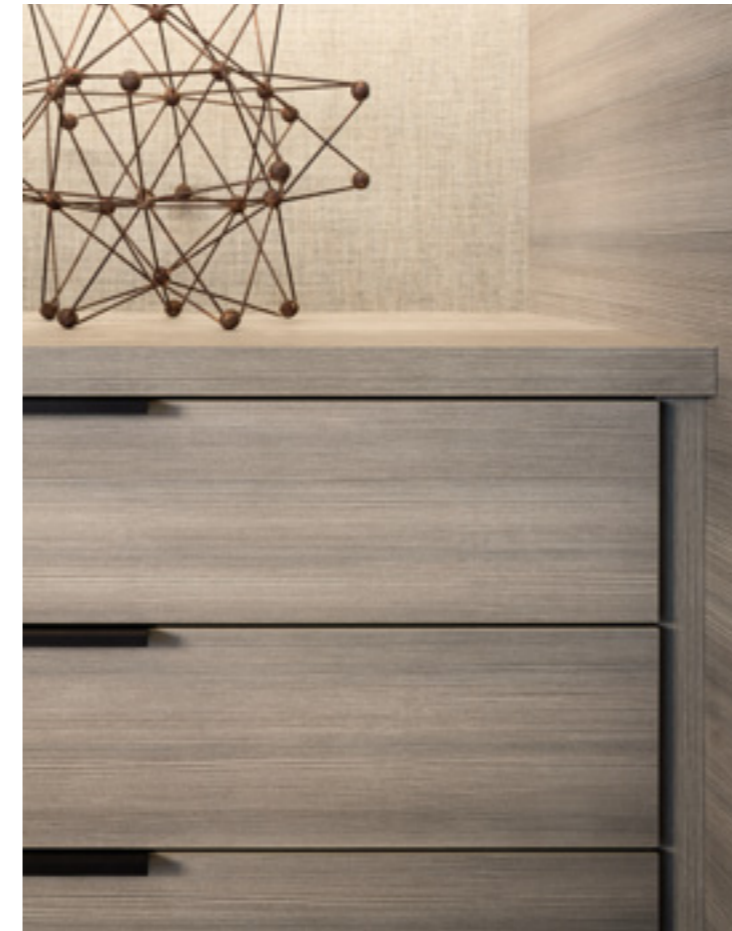

Comfort

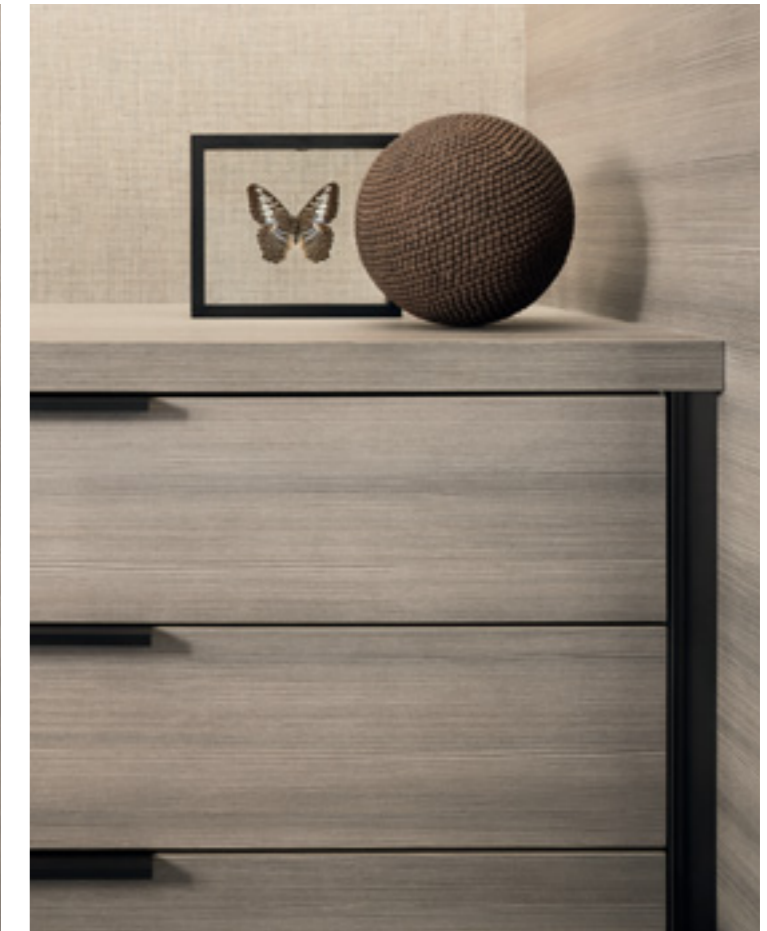

Tech

Dimensioni generali Overall dimensions

7 larghezze 7 widths

432 - 478 - 570 - 707 -
889 - 981 - 1165
17" - 18¾" - 22½" -
27¾" - 35" - 38½" - 45¾"

3 altezze 3 heights

375 - 695 - 1015
14¾" - 27¾" - 40"

1 profondità 1 depth

500 - 19¾"

Tipologie Types

Comfort
Tech

Finiture struttura Structure finishings

Melaminico canvas
Melaminico lino
Melaminico visone
Melaminico larice
sbiancato
Melaminico moka
Melaminico larice grigio

Melamine canvas
Melamine lino
Melamine visone
Melamine bleached larch
Melamine moka
Melamine larch grey

Finiture interno cassetti Interior drawers finishings

Melaminico stone
Melamine stone

Maniglia e profili* Handle and profiles*

Metallo verniciato bronzo
epox M421
Metallo verniciato sand
epox M455

Metal bronze epox
painted M421
Metal sand epox painted
M455

*

Profili in metallo solo
per versione Tech

Profiles in metal only
for Tech version

Cassettiere Speciali — Special drawers unit

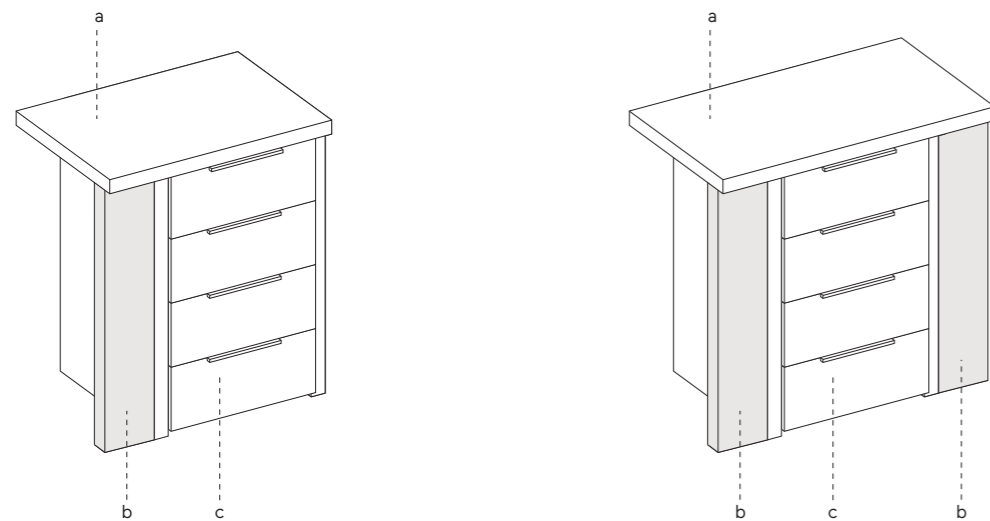

Questa particolare soluzione è ideale in situazioni che non consentono l'utilizzo di cassettiere standard o dove l'apertura dei cassetti è vincolata dalla modalità di apertura delle ante:

- colonne ridotte in larghezza
- colonne ante battenti con cerniere apertura 165°
- composizioni particolari di armadio scorrevole con differenti misure di ante
- composizioni armadio coplanari ad ante dispari

This solution is perfect where standard drawer units can't be used or where the opening of the drawers is restricted by the door opening mode:

- reduced width columns
- columns with hinged doors with 165° opening hinges
- sliding door wardrobe with different doors dimensions
- coplanar wardrobe with odd doors

Descrizione Description

- a. coperchio larghezza colonna
- b. fascia di compensazione larghezza minima 46
- c. cassetti standard nelle dimensioni a collezione

- a. column-width tops
- b. compensation strips minimum width 46
- c. standard drawers in collection dimensions

Nota Note

Non realizzabile per cassettiere sospese

Not possible for suspended drawer units

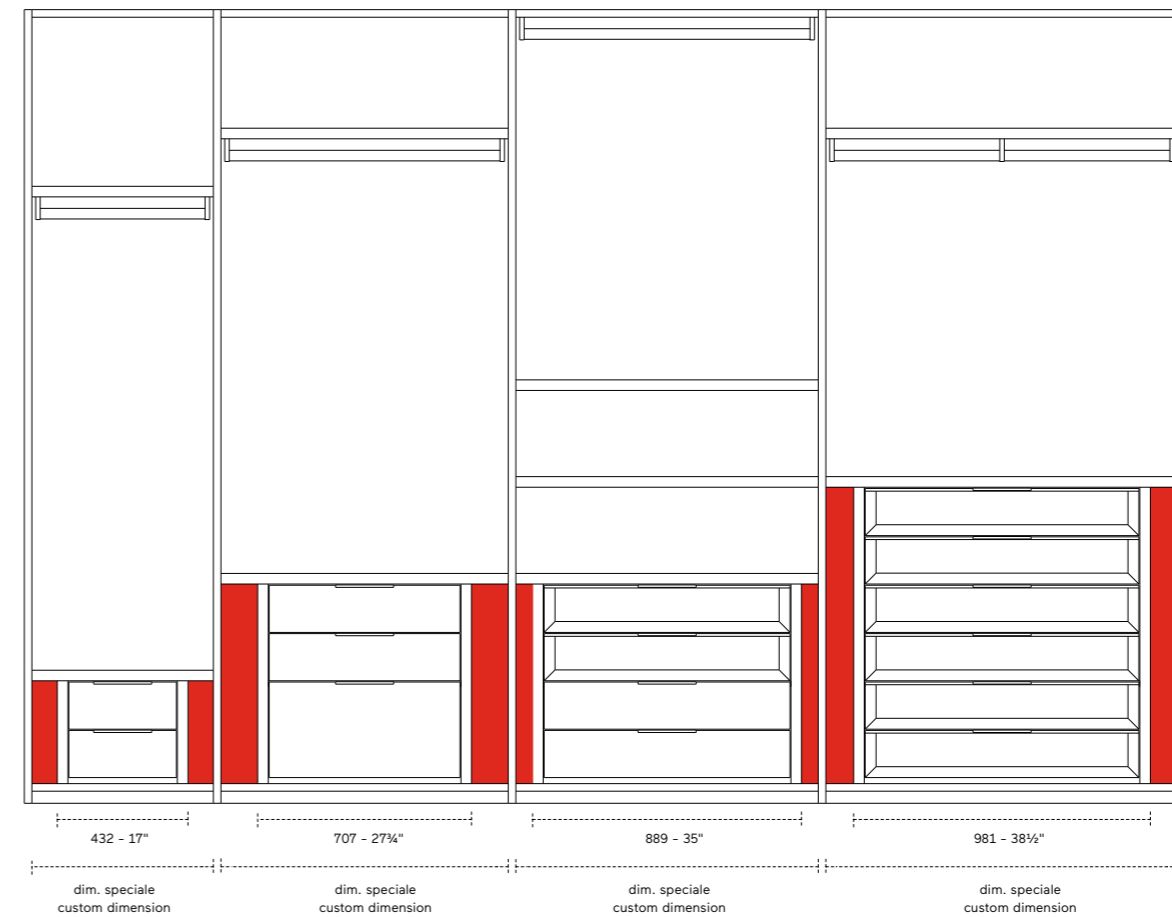

Esempi compositivi Composition examples

Inserimento cassettiere con dimensioni standard in colonne fuori misura

Insertion of drawer units with standard dimensions in bespoke columns

Tipologie di cassetti — Drawer units types

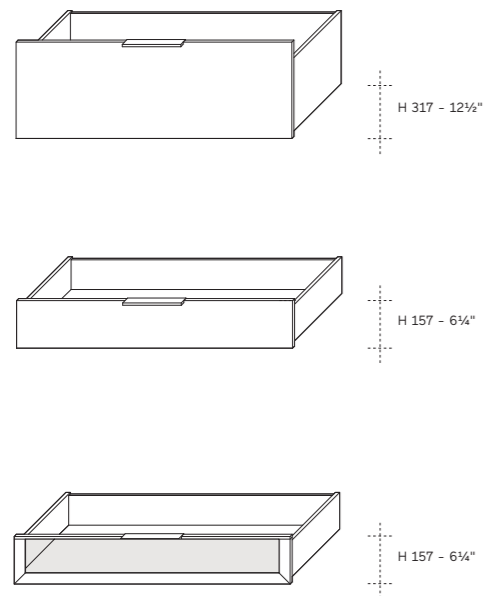

Caratteristiche generali General features

Larghezza Width

Cassettiere Drawer units width	Frontale cassetto Drawer front
432 - 17"	356 - 14"
478 - 18 3/4"	402 - 15 3/4"
570 - 22 1/2"	494 - 19 1/2"
707 - 27 3/4"	631 - 24 3/4"
889 - 35"	813 - 32"
981 - 38 1/2"	905 - 35 3/4"
1165 - 45 3/4"	1089 - 42 3/4"

Profondità Depth

469 - 18 1/2"

Finiture Finishings

Frontali legno:
melaminico 6 varianti
Frontali in vetro:
melaminico 6 varianti
e vetro trasparente

Wood fronts:
melamine 6 variants
Glass fronts:
melamine 6 variants and
transparent glass

Maniglia Handle

Metallo verniciato:
bronzo epox M421
sand epox M455

Metal painted:
bronze epox M421
sand epox M455

**Struttura cassetto
Drawer structure**
Melaminico stone
Melamine stone

Nota Note

Tutti i cassetti sono montati su guide a scomparsa con rientro automatico e rallentatore. Possibilità di scelta tra guide ad estrazione parziale o totale

All drawers are mounted on hidden rails with an automatic return mechanism and soft closing mechanism. Possibility of choosing partial or total extraction guides



Cassetto con frontale in legno

Frontale cassetto H mm. 317 in melaminico 6 varianti, maniglia in metallo verniciato epox bronzo o sand. Interno cassetto in melaminico stone. Cassetto con chiusura ammortizzata ad estrazione totale o parziale

Drawer with wood front

Drawer front H 12 1/2" in a choice of 6 types of melamine, handle in sand or bronze epox painted metal. Drawer interior in stone melamine. Full or partial extension drawers with soft-close mechanism



Cassetto con frontale in legno

Frontale cassetto H mm. 157 in melaminico 6 varianti, maniglia in metallo verniciato epox bronzo o sand. Interno cassetto in melaminico stone. Cassetto con chiusura ammortizzata ad estrazione totale o parziale

Drawer with wood front

Drawer front H 6 1/4" in a choice of 6 types of melamine, handle in sand or bronze epox painted metal. Drawer interior in stone melamine. Full or partial extractable drawers with soft-close mechanism



Cassetto con frontale in vetro

Frontale cassetto H mm. 157 in vetro trasparente e cornice in melaminico 6 varianti, maniglia in metallo verniciato epox bronzo o sand. Interno cassetto in melaminico stone. Cassetto con chiusura ammortizzata ad estrazione totale o parziale

Drawer with glass front

Drawer front H 6 1/4" in transparent glass and frame in a choice of 6 variants of melamine, handle in sand or bronze epox painted metal. Drawer interior in stone melamine. Full or partial extension drawer with soft-close mechanism

Capienza — Capacity



Larghezza Width

Cassettera Drawer	Vano interno utile Internal dimensions
01 432 - 17"	321 - 12¾"
02 478 - 18¾"	367 - 14½"
03 570 - 22½"	459 - 18"
04 707 - 27¾"	596 - 23½"
05 889 - 35"	778 - 30¾"
06 981 - 38½"	870 - 34½"
07 1165 - 45¾"	1054 - 41½"

Profondità cassettera Drawer depth	Vano interno utile Drawer inner dimension
469 - 18½"	436 - 17¼"

Sezione cassetto — Drawer section

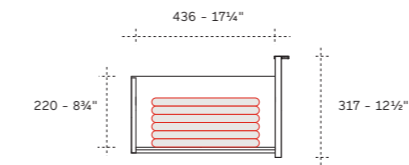

Cassetto frontale legno H 317
Wood drawer front H 12½"

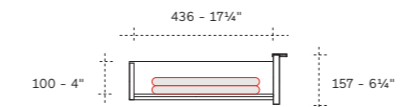

Cassetto frontale legno H 157
Wood drawer front H 6¼"

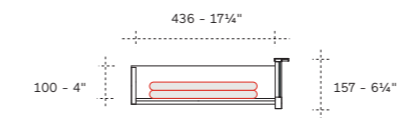

Cassetto frontale vetro H 157
Glass drawer front H 6¼"

Tipologia cassettiere — Drawer unit types

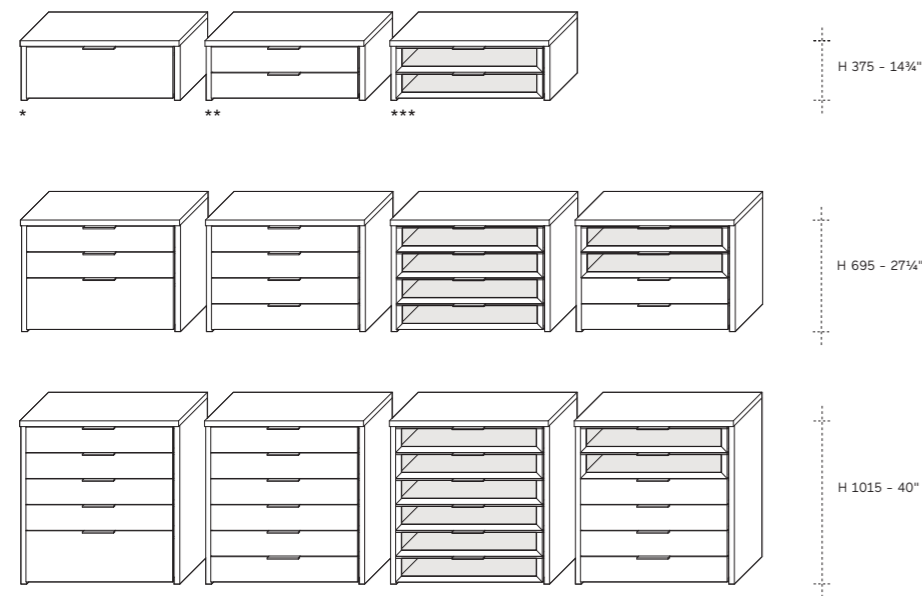

Cassettiere singola Single drawer unit

Larghezza totale Overall width

432 - 478 - 570 - 707 -
889 - 981 - 1165
17" - 18 3/4" - 22 1/2" -
27 3/4" - 35" - 38 1/2" -
45 3/4"

Altezza Height

375 - 695 - 1015
14 1/4" - 27 1/4" - 40"

Profondità Depth

500 - 19 3/4"

Nota Note

- *
Cassetto frontale legno
Wood drawer front
H 317
H 12 1/2"
In presenza di fianco
interno telaio o
fianco esterno vetro,
considerare uno o due
traversi di supporto
- **
Cassetto frontale legno
Wood drawer front
H 157
H 6 1/4"
Where an internal frame
side or external side in
glass is present, consider
using one or two support
traverses
- ***
Cassetto frontale vetro
Glass drawer front
H 157
H 6 1/4"

Tipologia cassettiere — Drawer unit types

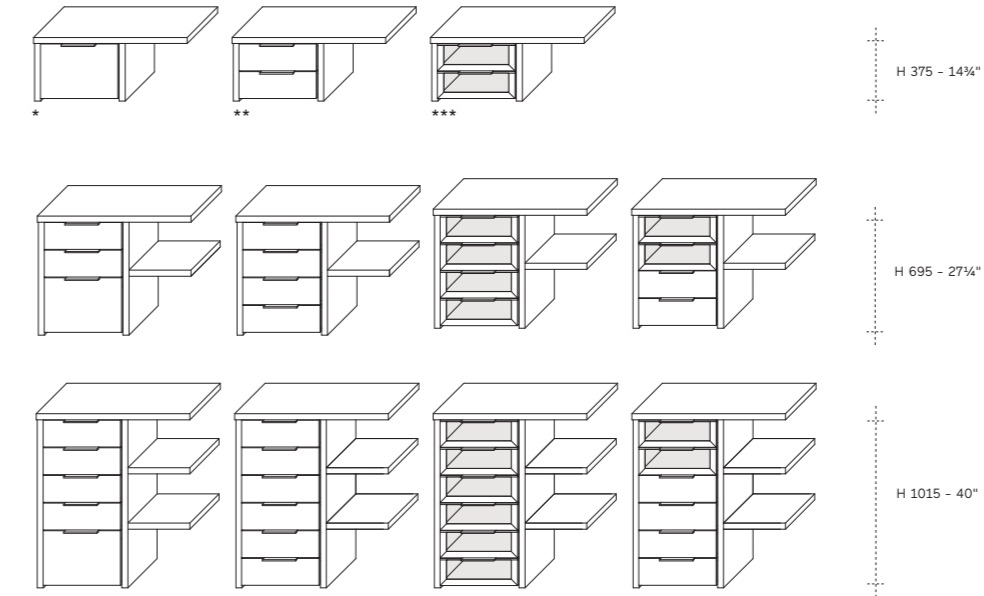

Cassettiere con vano a giorno Drawer unit with open element

Larghezza totale Overall width	Cassettiere Drawer unit	Vani a giorno Open element
889 - 35"	478 - 18 3/4"	411 - 16 1/4"
981 - 38 1/2"	570 - 22 1/2"	411 - 16 1/4"
1165 - 45 3/4"	570 - 22 1/2"	595 - 23 1/2"

Altezza Height

375 - 695 - 1015
14 1/4" - 27 1/4" - 40"

Profondità Depth

500 - 19 3/4"

Nota Note

- *
Cassetto frontale legno
Wood drawer front
H 317
H 12 1/2"
In presenza di fianco
interno telaio o
fianco esterno vetro,
considerare uno o due
traversi di supporto
- **
Cassetto frontale legno
Wood drawer front
H 157
H 6 1/4"
Where an internal frame
side or external side in
glass is present, consider
using one or two support
traverses
- ***
Cassetto frontale vetro
Glass drawer front
H 157
H 6 1/4"

Cassettiere sospese — Hanging drawer units

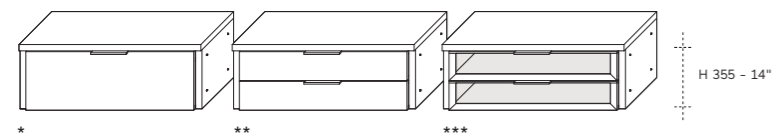

Cassettiera sospesa Suspended drawer

Larghezza totale
Overall width
432 - 478 - 570 - 707 -
889 - 981 - 1165
17" - 18¾" - 22½" -
27¾" - 35" - 38½" -
45¾"

Altezza
Height
355 - 14"

Profondità
Depth
500 - 19¾"

Nota Note

- *
Cassetto frontale legno
Wood drawer front
H 317
H 12½"
- In presenza di fianco interno telaio o fianco esterno vetro, considerare uno o due traversi di supporto
- **
Cassetto frontale legno
Wood drawer front
H 157
H 6¼"
- Where an internal frame side or external side in glass is present, consider using one or two support traverses
- ***
Cassetto frontale vetro
Glass drawer front
H 157
H 6¼"

Isola — Island

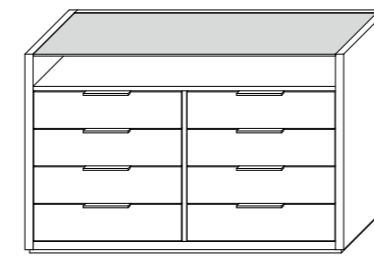

01

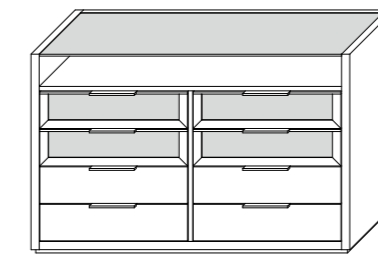

02



03

01 - 02

Isola
Island
Elemento a cassetti indipendente

Free standing drawers unit

Larghezza
Width
1361
53½"

Altezza
Height
854
33½"

Profondità
Depth
534
21"

03

Tappetino per isola
cassettiera
Island drawer unit pad
Posizionato nel vano sottostante il top in vetro trasparente

Positioned in the compartment underneath the transparent glass top

Larghezza
Width
1288
50¾"

Profondità
Depth
498
19½"

Finitura
Finishing
Pelle sintetica color moka

Synthetic leather moka colour

Finitura composizione 01 Finishing composition 01

Top
Top
vetro trasparente
transparent glass

Struttura e cassetti
Structure and drawers
Isola in melaminico 6 varianti
Isola in laccato opaco LCT

Island available in 6 melamines variants. Island in LCT matt lacquered

Maniglia
Handle
Metallo verniciato: bronzo epox M421 sand epox M455

Metal painted: bronze epox M421 sand epox M455

Finitura composizione 02 Finishing composition 02

Top e frontale cassetti
Front of drawers and top
vetro trasparente
transparent glass

Struttura e cassetti
Structure and drawers
Melaminico 6 varianti
6 variants of melamines

Maniglia
Handle
Metallo verniciato: bronzo epox M421 sand epox M455

Metal painted: bronze epox M421 sand epox M455

Accessori cassettiere — Drawer unit accessories



01



02

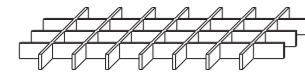

03

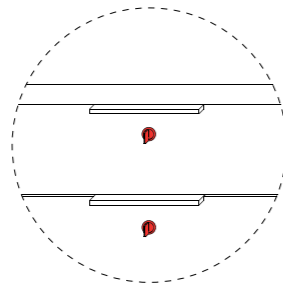

04

01

Tappetino per coperchio cassettiere
Pad for drawer unit cover

Larghezza
Width

Per colonna da
432 - 478 - 570 - 707 -
889 - 981 - 1165

For column width
17" - 18¾" - 22½" -
27¾" - 35" - 38½" -
45¾"

Finiture
Finishings

Pelle sintetica color
moka

Synthetic leather moka
colour

02

Tappetino per interno cassetto
Pad for drawer interiors

Larghezza
Width

Per colonna da
432 - 478 - 570 - 707 -
889 - 981 - 1165

For column width
17" - 18¾" - 22½" -
27¾" - 35" - 38½" -
45¾"

Finiture
Finishings

Pelle sintetica color
moka

Synthetic leather moka
colour

03

Griglia accessori per interno cassetto
Grid accessories for drawer interiors

Larghezza
Width

Per colonna da
432 - 478 - 570 - 707 -
889 - 981 - 1165

For column width
17" - 18¾" - 22½" -
27¾" - 35" - 38½" -
45¾"

Altezza
Height

65 - 2½"

Capienza
Capacity

Vedi pag. 204
On p. 204

Finiture
Finishings

Melaminico stone
Melamine stone

04

Serratura per cassetto legno
Locks for wooden drawer

Disponibile per tutti i
cassetti con fronte legno

Available for all drawers
with wooden fronts

Finiture
Finishings

Nichel
Nickel



Tappetino per coperchio cassettiere
Tappetino in pelle sintetica color moka, in appoggio su top cassettiere

Pad for drawer unit cover
Pad in synthetic leather moka colour for top of drawer unit



Tappetino per interno cassetti
Tappetino in pelle sintetica color moka, posizionabile su fondo cassetti con frontale in vetro o legno

Pad for drawer interiors
Pad in synthetic leather moka colour for bottom of glass or wood front drawers



Griglia accessori
Griglia accessori per interno cassetti, realizzata in melaminico stone. Disponibile per cassetti con frontale in legno e vetro

Grid accessories
Grid accessories for drawer interiors, produced in stone melamine. Available for drawers glass or wood front drawers



Serratura per cassetto legno
Serratura opzionale installabile su tutti i cassetti in collezione con frontale in legno

Locks for wooden drawer
Optional lock that can be installed in all drawers in the collection with wooden fronts

illuminazione orizzontale — Horizontal illumination

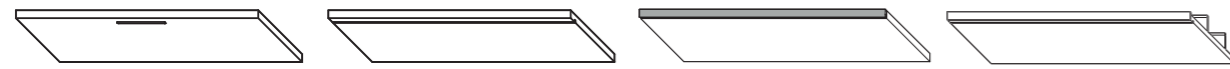

01*

02*

03*

04*

01

Lampada Led incassata Built-in Led light
Possibilità di incasso in coperchi e ripiani comfort. Accensione tramite interruttore o automatica con sensore IR inserito nel coperchio. Lampada a gradazione calda 3000° K - 110V o 230V

Can be recessed in covers and comfort shelves. Manually switched or automatic power-on via infrared sensor inserted in the cover. Warm color temperature of light 3000° K - 110V or 230V

Potenza Power
3,5 watts

Finiture Finishings
Profilo in metallo verniciato:
bronzo epox M421
sand epox M455

Painted metal frame:
bronzo epox M421
sand epox M455

02

Lampada Stripe Led Led stripe
Possibilità di incasso in coperchi e ripiani comfort. Accensione tramite interruttore o automatica con sensore IR inserito nel coperchio. Lampada a gradazione calda 3000° K - 110V o 230V

Can be recessed in covers and shelves. Manually switched or automatic power-on via infrared sensor inserted in the cover. Warm color temperature of light 3000° K - 110V or 230V

Larghezza ripiano Width of shelf	Potenza Power
432 - 17"	W 4,56
478 - 18¾"	W 5,13
570 - 22½"	W 6,27
707 - 27¾"	W 7,70
889 - 35"	W 9,98
981 - 38½"	W 10,83
1165 - 45¾"	W 13,00

03

Lampada Stripe Led per ripiano Tech Led stripe for Tech shelf
Incassata nel profilo in metallo applicato sul fronte del ripiano. Accensione tramite interruttore o automatica con sensore IR inserito nel coperchio. Lampada a gradazione calda 3000° K - 110V o 230V

Inserted in to the metal front profile of the shelf. Manually switched or automatic power-on via infrared sensor inserted in the cover. Warm color temperature of light 3000° K - 110V or 230V

Larghezza ripiano Width of shelf	Potenza Power
432 - 17"	W 4,56
478 - 18¾"	W 5,13
570 - 22½"	W 6,27
707 - 27¾"	W 7,70
889 - 35"	W 9,98
981 - 38½"	W 10,83
1165 - 45¾"	W 13,00

04

Lampada Stripe Led per ripiano portascarpe fisso in legno Led stripe for tilted shoe rack in wood
Accensione tramite interruttore o automatica con sensore IR inserito nel coperchio. Lampada a gradazione calda 3000° K - 110V o 230V

Manually switched or automatic power-on via infrared sensor inserted in the cover. Warm color temperature of light 3000° K - 110V or 230V

Larghezza ripiano Width of shelf	Potenza Power
432 - 17"	W 4,56
478 - 18¾"	W 5,13
570 - 22½"	W 6,27
707 - 27¾"	W 7,70
889 - 35"	W 9,98
981 - 38½"	W 10,83
1165 - 45¾"	W 13,00

*

In presenza di fianco interno telaio o fianco esterno vetro, considerare uno o due traversi di supporto

Where an internal frame side or external side in glass is present, consider using one or two support traverses

Nota Note

È possibile inserire massimo 6 lampade per colonna d'armadio

Maximum 6 lights can be installed per wardrobe column



Lampada a led incassata
Disponibile per ripiani comfort e coperchi. Profilo in metallo verniciato epox bronzo o sand. Accensione automatica o tramite interruttore. Gradazione calda 3000° K - 110 V/230 V

Recessed led light
Available for Comfort shelves and covers. Profile in sand or bronze epox painted metal. Automatic or manually switched power-on. Warm color temperature 3000° K - 110V/230 V



Lampada Stripe led
Disponibile per ripiani comfort e coperchi. Accensione automatica o tramite interruttore. Gradazione calda 3000° K - 110 V/230 V

Led stripe
Available for Comfort shelves and covers. Automatic or manually switched power-on. Warm color temperature 3000° K - 110V/230 V



Lampada Stripe led per ripiano Tech
Lampada a led incassata nel profilo in metallo. Disponibile per tutte le larghezze di ripiano. Accensione automatica o tramite interruttore. Gradazione calda 3000° K - 110 V/230 V

Led stripe for Tech shelf
Led light recessed into metal profile. Available for all shelf widths. Automatic or manually switched power-on. Warm color temperature 3000° K - 110V/230 V



Lampada Stripe led per ripiano portascarpe fisso in legno
Disponibile per le larghezze di vano 432, 478, 570, 707, 889, 981, 1165. Accensione automatica o tramite interruttore. Gradazione calda 3000° K - 110 V/230 V

Led stripe for tilted shoe rack
Available for element widths 17", 18¾", 22½", 27¾", 35", 38½", 45¾". Automatic or manually switched power-on. Warm color temperature 3000° K - 110V/230 V

illuminazione orizzontale — Horizontal illumination



05*

06*

07*

05

Lampada Stripe Led per ripiani in vetro
Led stripe for glass shelves

Incassata nel telaio in metallo del ripiano. Accensione tramite interruttore o automatica con sensore IR inserito nel coperchio. Lampada a gradazione calda 3000° K - 110V o 230V

Recessed into metal profile of the shelf. Manually switched or automatic power-on via infrared sensor inserted in the cover. Warm color temperature of light 3000° K - 110V or 230V

Larghezza ripiano	Potenza
Width of shelf	Power
432 - 17"	W4,28
478 - 18¾"	W4,85
570 - 22½"	W5,99
707 - 27¾"	W7,41
889 - 35"	W9,41
981 - 38½"	W10,55
1165 - 45¾"	W12,83

06

Lampada Stripe Led per ripiani in pelle sintetica
Led stripe for shelves in synthetic leather

Incassata nel telaio in metallo del ripiano. Accensione tramite interruttore o automatica con sensore IR inserito nel coperchio. Lampada a gradazione calda 3000° K - 110V o 230V

Recessed into metal profile of the shelf. Manually switched or automatic power-on via infrared sensor inserted in the cover. Warm color temperature of light 3000° K - 110V or 230V

Larghezza ripiano	Potenza
Width of shelf	Power
432 - 17"	W4,28
478 - 18¾"	W4,85
570 - 22½"	W5,99
707 - 27¾"	W7,41
889 - 35"	W9,41
981 - 38½"	W10,55
1165 - 45¾"	W12,83

07

Lampada Stripe Led per ripiano portascarpe fisso in vetro
Led stripe for tilted shoe rack in glass

Incassata nel telaio in metallo del ripiano. Accensione tramite interruttore o automatica con sensore IR inserito nel coperchio. Lampada a gradazione calda 3000° K - 110V o 230V

Recessed into metal profile of the shelf. Manually switched or automatic power-on via infrared sensor inserted in the cover. Warm color temperature of light 3000° K - 110V or 230V

Larghezza ripiano	Potenza
Width of shelf	Power
889 - 35"	W9,41
981 - 38½"	W10,55
1165 - 45¾"	W12,83

*

In presenza di fianco interno telaio o fianco esterno vetro, considerare uno o due traversi di supporto

Where an internal frame side or external side in glass is present, consider using one or two support traverses

Nota

È possibile inserire massimo 6 lampade per colonna d'armadio

Maximum 6 lights can be installed per wardrobe column



Lampada Stripe led per ripiani in vetro
Disponibile per le larghezze di vano 432, 478, 570, 707, 889, 981, 1165. Accensione automatica o tramite interruttore. Gradazione calda 3000°K - 110 V/230 V

Led stripe for glass shelves
Available for element widths 17", 18¾", 22½", 27¾", 35", 38½", 45¾". Automatic or manually switched power-on. Warm color temperature 3000°K - 110V/230 V



Lampada Stripe led per ripiani in pelle sintetica
Disponibile per le larghezze di vano 432, 478, 570, 707, 889, 981, 1165. Accensione automatica o tramite interruttore. Gradazione calda 3000°K - 110 V/230 V

Led stripe for shelves in synthetic leather
Available for element widths 17", 18¾", 22½", 27¾", 35", 38½", 45¾". Automatic or manually switched power-on. Warm color temperature 3000°K - 110V/230 V



Lampada Stripe led per ripiano portascarpe fisso in vetro
Disponibile per le larghezze di vano 889, 981, 1165. Accensione automatica o tramite interruttore. Gradazione calda 3000°K - 110 V/230 V

Led stripe for glass shoe rack
Available for element widths 35", 38½", 45¾". Automatic or manually switched power-on. Warm color temperature 3000°K - 110V/230 V

Illuminazione verticale — Vertical illumination

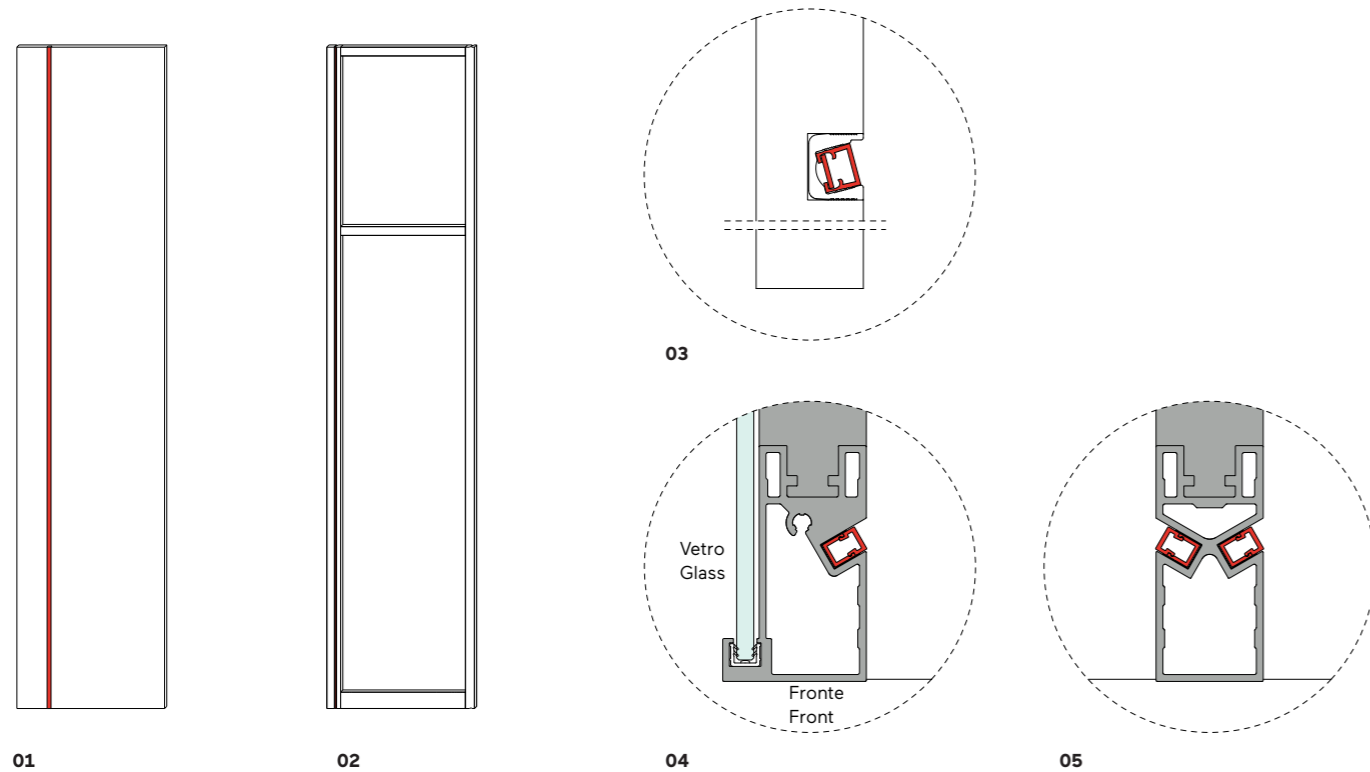

01

02

03

04

05

01

Lampada Stripe Led per fianco in melaminico
Led stripe for melamine sidepanel

Incassata nei fianchi in melaminico dell'armadio. Accensione tramite interruttore o automatica con sensore IR inserito nel coperchio. Lampada a gradazione calda 3000° K - 110V o 230V

Recessed into the interior sides of the wardrobe. Manually switched or automatic power-on via infrared sensor inserted in the cover. Warm color temperature of light 3000° K - 110V or 230V

Altezza fianco	Potenza
Height of side	Power
2048 - 80¾"	W 22,42
2368 - 93¾"	W 26,22
2464 - 97"	W 26,98
2624 - 103¾"	W 28,88
2880 - 113½"	W 31,92

02

Lampada mini stripe Led per fianco telaio e ante battenti
Mini stripe led for frame side panel

Incassata nei montanti anteriori dei fianchi telaio interni/esterni. Accensione automatica con sensore IR inserito nel coperchio. Lampada a gradazione calda 3000° K - 110V o 230V

Recessed into the front uprights of the internal and external frame sides. Automatic turning-on with IR sensor inserted in the top. Warm light lamp 3000° K - 110V or 230V

Altezza fianco	Potenza
Height of side	Power
2368 - 93¾"	W22,73
2464 - 97"	W23,83
2624 - 103¾"	W25,30
2880 - 113½"	W28,23

Lampada mini stripe Led per fianco telaio e armadio Open
Mini stripe led for frame side panel

Incassata nei montanti anteriori dei fianchi telaio interni/esterni. Accensione tramite radiocomando in presenza di centralina dimmerabile o presa comandata presente in loco. Lampada a gradazione calda 3000° K - 110V o 230V

Recessed into the front uprights of the internal and external frame sides. Automatic turning-on by radio control with control unit or socket. Warm light lamp 3000° K - 110V or 230V

Altezza fianco	Potenza
Height of side	Power
2368 - 93¾"	W 24,93
2464 - 97"	W 26,03
2624 - 103¾"	W 27,86
2880 - 113½"	W 30,43

03

Sezione fianco melaminico con luce

Section of melamine side panel

04

Sezione fianco telaio esterno con vetro con mini stripe led

External frame side section with glass and mini LED stripe

05

Sezione fianco telaio interno con luce led. Possibilità di inserimento luce sia a destra che a sinistra del fianco

Housed in the frame side, the mini LED stripe is interrupted by hinges where present

Nota
Note

La continuità della luce mini stripe led alloggiata nel fianco telaio, si interrompe in corrispondenza delle cerniere quando previste

Internal frame side section with LED light. Lighting can be positioned on both the left and right of the side



Schema illuminazione — Lighting details

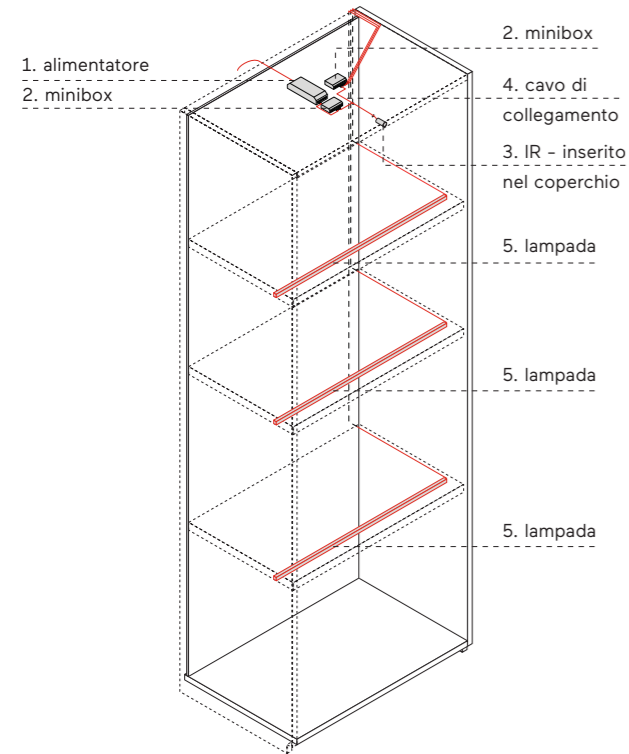

a. Illuminazione orizzontale con fianco in melaminico
Horizontal lighting for wood side panel

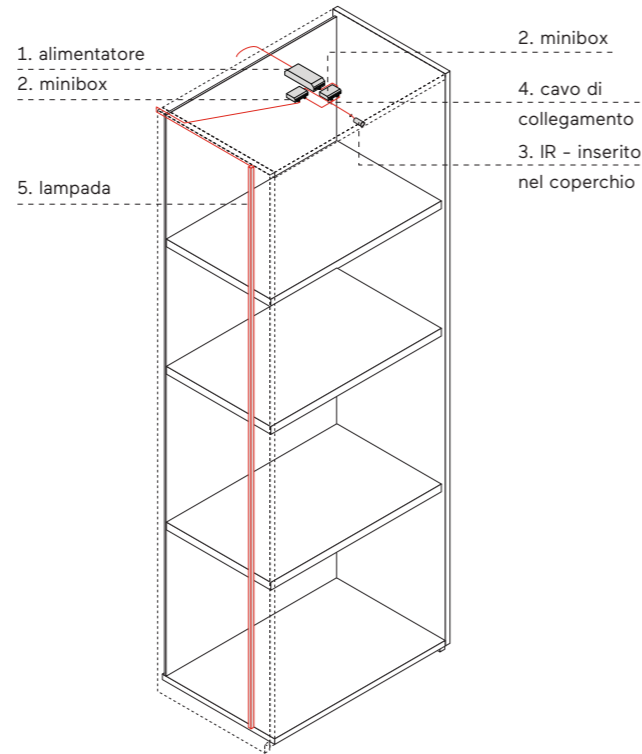

b. Illuminazione verticale con fianco in melaminico
Vertical lighting for wood side panel

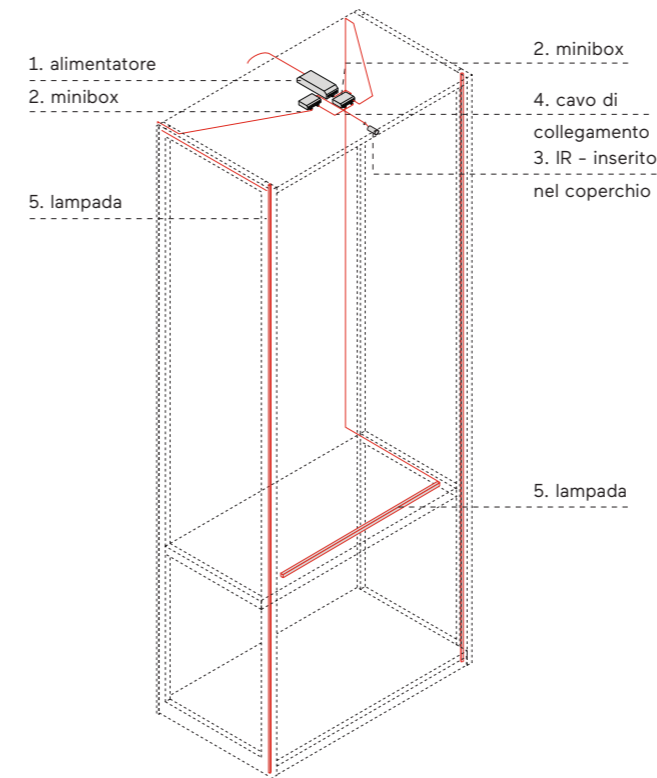

c. Illuminazione verticale e orizzontale con fianco telaio
Horizontal and vertical lighting for frame side panel

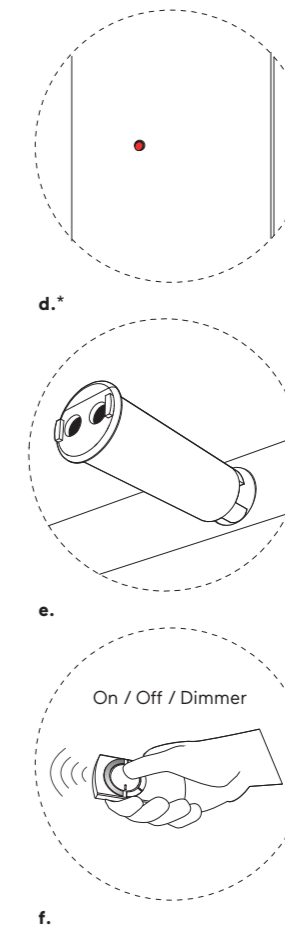

Descrizione Description		Componenti Components
a. Schema illuminazione orizzontale con fianco melaminico	a. Horizontal lighting layout with melamine side	1. Alimentatore 110V o 230V
b. Schema illuminazione verticale con fianco in melaminico	b. Vertical lighting layout with melamine side	2. Minibox
c. Schema illuminazione orizzontale e verticale con fianco telaio	c. Horizontal and vertical lighting layout with frame side	3. IR system inserito nel coperchio
d. Accensione led tramite interruttore incassato nel fianco in melaminico	d. LED turning-on by switch recessed into melamine side	4. Cavo di collegamento
e. Accensione tramite sistema IR inserito nel coperchio	e. Turning-on by IR system inserted in top	5. Lampada 3000°K
f. Accensione tramite radiocomando, quando presente la centralina dimmerabile	f. Turning-on by radio control, where dimmer present	1. Power supply unit 110V or 230V
		2. Minibox
		3. IR system inserted in top
		4. Connection cable
		5. 3000° K lamp

Illuminazione ed accensione
I sistemi d'illuminazione LED sono a luce calda 3000°K. L'accensione delle stripe led è disponibile in quattro modalità:
- tramite sensore IR inserito nel coperchio con ante battenti o scorrevoli o complanari
- tramite interruttore incassato nel lato interno del fianco in melaminico
- tramite presa comandata prevista in loco
- tramite radiocomando quando presente la centralina dimmerabile

LED lighting systems are warm light 3000° K. LED stripe turning-on available in four modes:
- by IR sensor inserted in top with hinged, sliding or coplanar doors
- by switch recessed into the internal melamine side
- by socket installed in situ
- by radio control, where dimmer present

Dimmer
Tutti i sistemi di illuminazione Lema sono disponibili anche con funzione dimmerabile, che dovrà essere richiesta in fase di ordine

Il kit che verrà fornito sarà composto da una centralina per alimentatore e radiocomando per composizione

Il nostro ufficio tecnico in fase di ordine si occuperà di calcolare il numero di centraline in funzione della quantità di alimentatori necessari allo sviluppo dell'ordine stesso

All Lema lighting systems are available with dimmable function, which must be requested when an order is placed

The kit supplied will include one control unit per power supply and one radio control per piece

During the order phase, our Technical Department will calculate the number of control units required based on the number of power supplies needed for the order in question

* Non disponibile in presenza di fianco telaio
Illuminazione orizzontale per fianco telaio disponibile solo con profilo elettrificato

Not available in the presence of frame side
Horizontal lighting for frame side only available if cable-free

Profilo elettrificato — Electrified profile

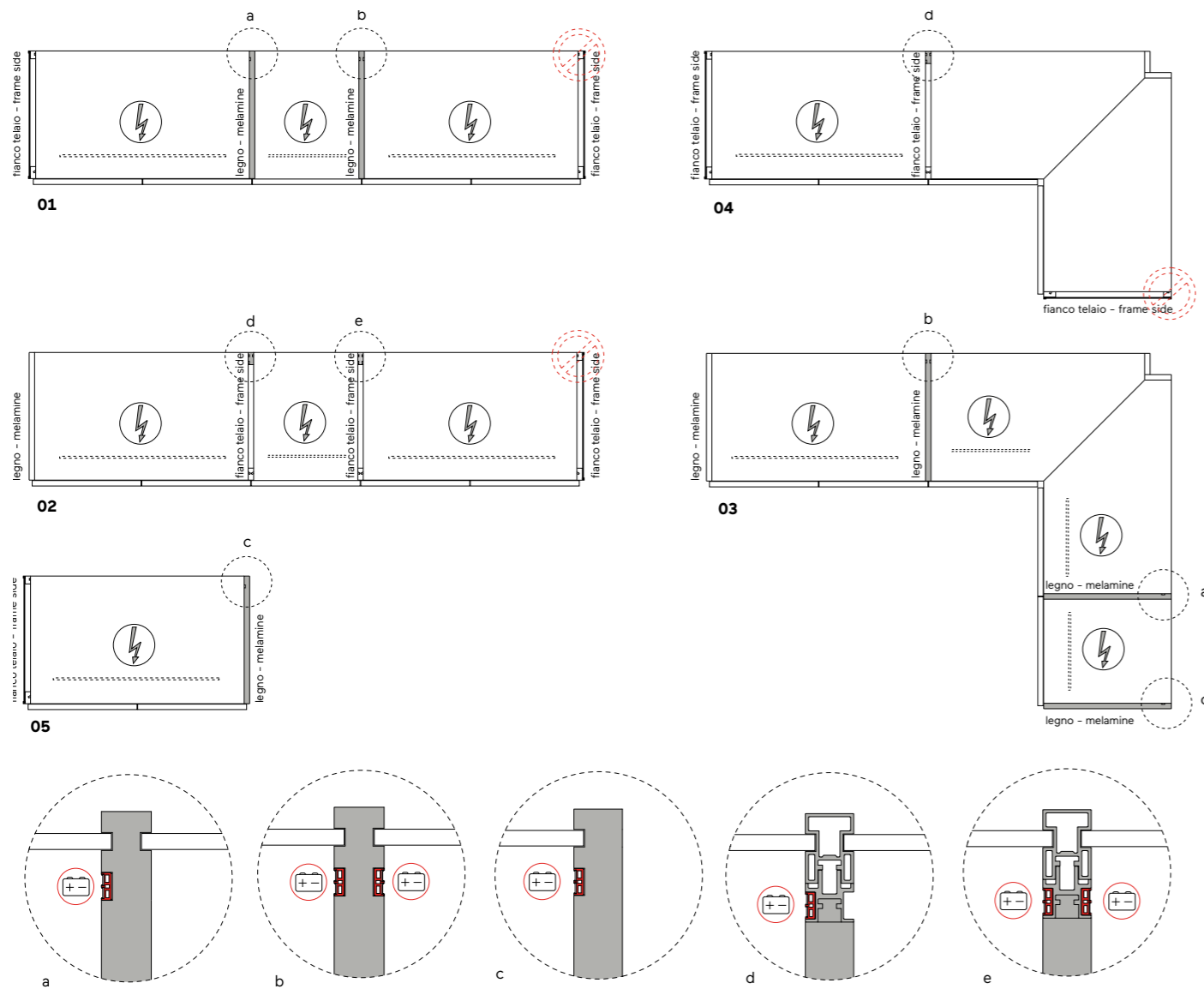

Profilo elettrificato Electrified profile

Per alimentare l'illuminazione orizzontale delle attrezzature presenti nelle composizioni d'armadio è possibile richiedere, durante l'ordine, l'inserimento di un profilo elettrificato alloggiato nei fianchi della composizione

La presenza di questo profilo garantisce il riposizionamento delle attrezzature all'altezza desiderata e l'aggiunta di ulteriori accessori successivamente all'ordine effettuato

To power horizontal lighting of wardrobe equipment, the inclusion of an electrified profile located in the sides can be requested when ordering

The presence of this profile guarantees the repositioning of the equipment at the desired height and the addition of further accessories after the order has been placed

Regole installazione profilo elettrificato Rules for installation of electrified profile

01. Il profilo elettrificato è disponibile esclusivamente per fianchi interni (melaminico o telaio) e fianchi esterni (melaminico)

The electrified profile is only available for internal sides (melamine or frame) or external sides (melamine)

02. Il profilo è sempre alloggiato sul lato sinistro del fianco interno

The profile is always positioned on the left side of the internal side

03. È possibile installare un solo profilo elettrificato per colonna d'armadio ad eccezione della colonna ad angolo dove il profilo è previsto su entrambi i fianchi interni

Only one electrified profile can be installed per wardrobe column, except for corner columns, where profiles are fitted on both internal sides

04. Non è possibile illuminare una colonna angolare se uno dei due fianchi è un fianco esterno vetro

Corner columns cannot be equipped with a lighting system if one of the two sides is an external side in glass

05. Non è possibile illuminare una colonna singola con 2 fianchi esterno vetro tramite profilo elettrificato

A single column with 2 external sides in glass cannot be equipped via electrified profile

Nota Note

In presenza di fondale in vetro l'illuminazione orizzontale è disponibile solamente con profilo elettrificato

If a glass back panel is present, horizontal lighting is only available with the electrified profile

<p>01. Il profilo elettrificato è disponibile esclusivamente per fianchi interni (melaminico o telaio) e fianchi esterni (melaminico)</p> <p>The electrified profile is only available for internal sides (melamine or frame) or external sides (melamine)</p> <p>02. Il profilo è sempre alloggiato sul lato sinistro del fianco interno</p> <p>The profile is always positioned on the left side of the internal side</p>	<p>03. È possibile installare un solo profilo elettrificato per colonna d'armadio ad eccezione della colonna ad angolo dove il profilo è previsto su entrambi i fianchi interni</p> <p>Only one electrified profile can be installed per wardrobe column, except for corner columns, where profiles are fitted on both internal sides</p> <p>04. Non è possibile illuminare una colonna angolare se uno dei due fianchi è un fianco esterno vetro</p>	<p>Corner columns cannot be equipped with a lighting system if one of the two sides is an external side in glass</p> <p>A single column with 2 external sides in glass cannot be equipped via electrified profile</p>	<p>Nota Note</p> <p>In presenza di fondale in vetro l'illuminazione orizzontale è disponibile solamente con profilo elettrificato</p> <p>If a glass back panel is present, horizontal lighting is only available with the electrified profile</p>
---	---	---	---

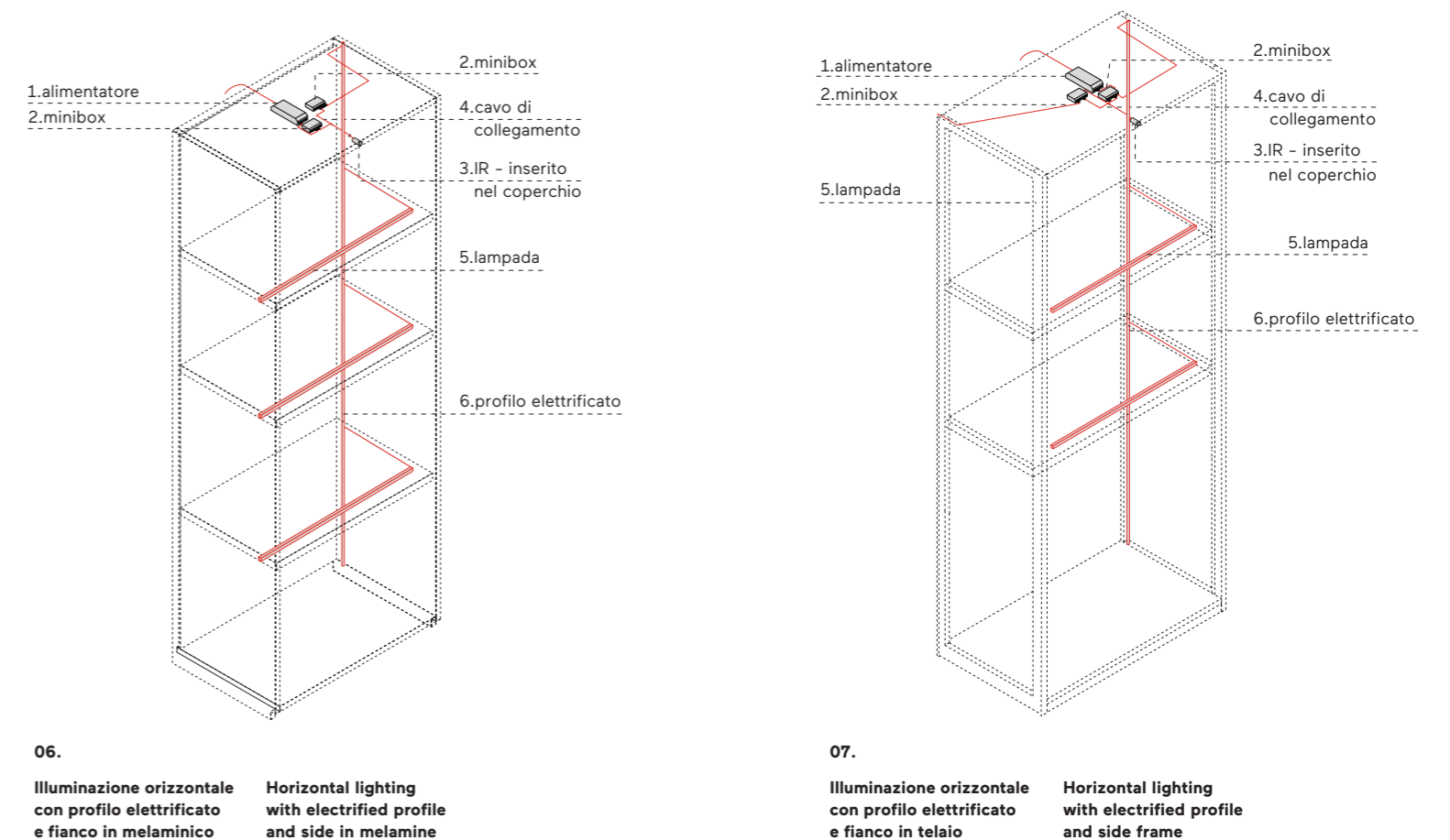

06.
Illuminazione orizzontale con profilo elettrificato e fianco in melaminico
Horizontal lighting with electrified profile and side in melamine

07.
Illuminazione orizzontale con profilo elettrificato e fianco in telaio
Horizontal lighting with electrified profile and side frame

Descrizione Description

06. Schema illuminazione orizzontale con fianchi in melaminico e profilo elettrificato

Horizontal lighting scheme with sides melamine and electrified profile

07. Schema illuminazione orizzontale con fianchi telaio e profilo elettrificato

Horizontal lighting scheme with frame sides and electrified profile

Illuminazione ed accensione Lighting and turning-on

I sistemi d'illuminazione LED sono a luce calda 3000°K. L'accensione è disponibile in tre modalità:
- tramite sensore IR inserito nel coperchio con ante battenti o scorrevoli o coplanari
- tramite presa comandata prevista in loco
- tramite radiocomando quando presente la centralina dimmerabile*

The LED lighting systems are warm light 3000°K. Three forms of turning-on available:
- by IR sensor inserted in top with hinged, sliding or coplanar doors
- by socket installed in situ
- by radio control, where dimmer present*

*

Il kit opzionale dimmerabile è composto da una centralina per ogni alimentatore presente nella composizione e radiocomando integrato

The optional dimmable kit features one control unit per power supply for each composition, together with an integrated radio control

Contenitore per cablaggi

Cable and power supply management

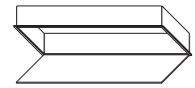

01

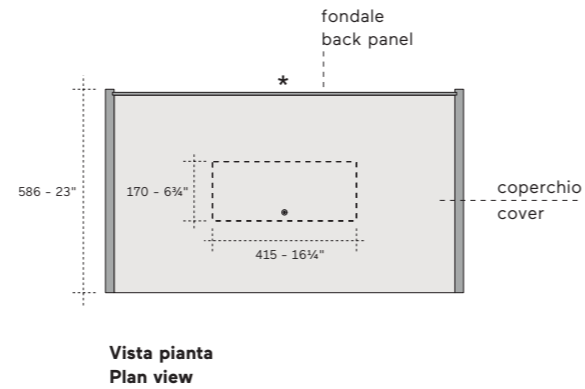
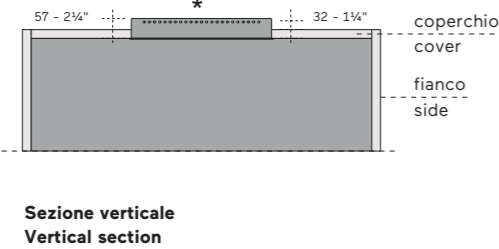

01

Contenitore per cablaggi

Cable holder for inspection

Soluzione per l'alloggio e la manutenzione dei componenti elettrici relativi al cablaggio delle lampade led presenti nell'armadio. Installato su coperchi e fondali, disponibile per colonne: 478 - 570 - 889 - 981 - 1165 18 3/4" - 22 1/2" - 35" - 38 1/2" - 45 3/4"

Solution for storing and maintaining electrical parts relating to cabling for LED lamps in the wardrobe.

Installed on tops and back panels, available for the following columns: 478 - 570 - 889 - 981 - 1165 18 3/4" - 22 1/2" - 35" - 38 1/2" - 45 3/4"

Larghezza

Width

415 - 16 1/4"

Altezza

Height

57 - 2 1/4"

Profondità

Depth

170 - 6 3/4"

Capienza

Capacity

Nr.2 alimentatori 70W affiancati. Cavi di collegamento e minibox

Nbr.2 x 70W power supplies placed together Connecting cables and minibox

Finiture

Finishings

Sportello in melaminico 6 varianti e profilo in metallo verniciato bronzo epox M421

Door available in a choice of 6 types of melamine with profile in epox bronze painted metal M421

*

Spazio minimo consigliato tra coperchio/fondale e soffitto/muro mm. 55

Recommended minimum space between cover/back panel and ceiling/wall 2 1/4"



Contenitore per cablaggi

Vano attrezzato per l'alloggio di cavi e trasformatori, installato su coperchi e fondali dell'armadio. Disponibile in melaminico 6 varianti e profilo in metallo verniciato bronzo epox. Apribile e ispezionabile tramite apposita chiave

Cable holder for inspection

Element equipped with casing for cables and transformers, installed on covers and backs of the wardrobe. Available in 6 types of melamine with profile in epox bronze painted metal. Cable holder can be opened and inspected by means of a special key



6. LEMA AIR CLEANING SYSTEM

Il nostro quotidiano, sempre più frenetico e intenso è un mosaico fatto di molteplici tessere: auto, treno, aereo, azienda, ufficio, riunioni, ristorante, palestra, centro commerciale, cena, incontri etc.

Gli ambienti che interessano la nostra vita, da indagini statistiche, sono sempre più spesso contaminati a causa di un non adeguato ricambio dell'aria. Batteri, muffe, monossido di carbonio, polveri sottili sono diventati parte integrante dell'aria che respiriamo e che va ad impregnarsi nei nostri indumenti generando, sovente, cattivi odori.

"Lema Air Cleaning System" (sviluppato con Air Control), intende rivoluzionare il concetto di armadio stesso, che diventa così, per la prima volta al mondo, un sistema in grado di decontaminare ed abbattere in modo significativo i batteri e gli odori di ciò che ne viene conservato al suo interno.

Ever more frantic and intense, our everyday life is a mosaic of different events: car, train, plane, company, office, meetings, restaurant, gym, shopping mall, dinner, gatherings, etc. Studies have shown that our environments are increasingly polluted by inadequate air circulation. Bacteria, molds, carbon monoxide and fine particles have become an integral part of the air we breathe. This same air then pervades our clothing, often generating unpleasant smells. "Lema Air Cleaning System" (developed with Air Control), aims to revolutionize the very concept of the wardrobe, which for the first time ever now becomes a system able to decontaminate and destroy to a significant degree those bacteria and smells emanating from the clothing stored inside.

Tecnologia — Technology

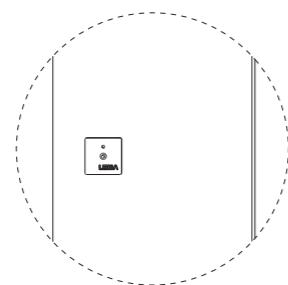
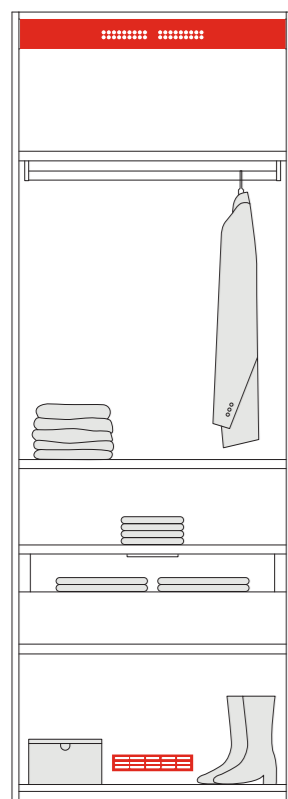

**Interruttore
Switch**

**Caratteristiche
Characteristics**

Diversi cicli di durata (da 2 a 8 ore). Sistema comandato da un interruttore multifunzione sul fianco dell'armadio. Sistema a basso voltaggio e amperaggio. Ventilazione ERP2018. Dispositivo silenzioso

A range of cycles lasting from 2 to 8 hours. The system is operated by a multifunctional switch placed on the side of the wardrobe. Low voltage and amperage system. ERP2018 ventilation. Silent action

**Benefici
Benefits**

Abbattimento della carica batterica. Riduzione degli odori oltre il 90%. Riduzione delle microparticelle nocive presenti nell'aria
Destruction of bacteria. Reduction odours by over 90%. Reduction of airborne particulate matter

**Manutenzione
inglese**

Sostituzione della lampada UV ogni 24 mesi. Contattare i nostri uffici per l'ordine e ricevere il ricambio
Replace UV lamp every 24 months. Contact our offices to place an order and get a replacement



**Lema air cleaning system
per fianco 586**

**Lema air cleaning system
for side panel 586**



**Lema air cleaning system
per fianco 442**

**Lema air cleaning system
for side panel 442**

Dettagli tecnici — Technical details

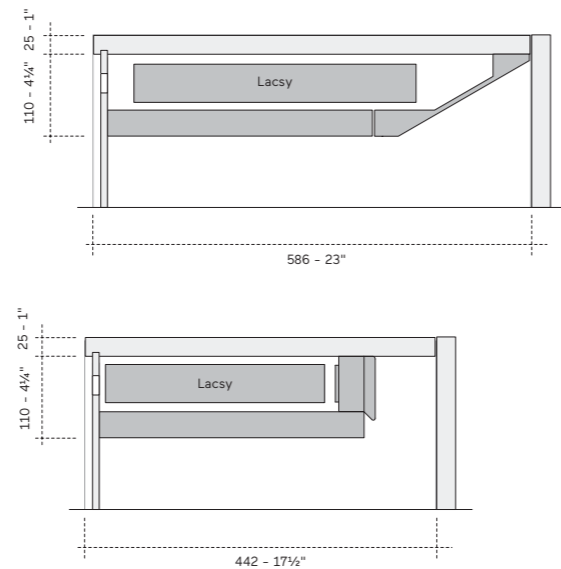
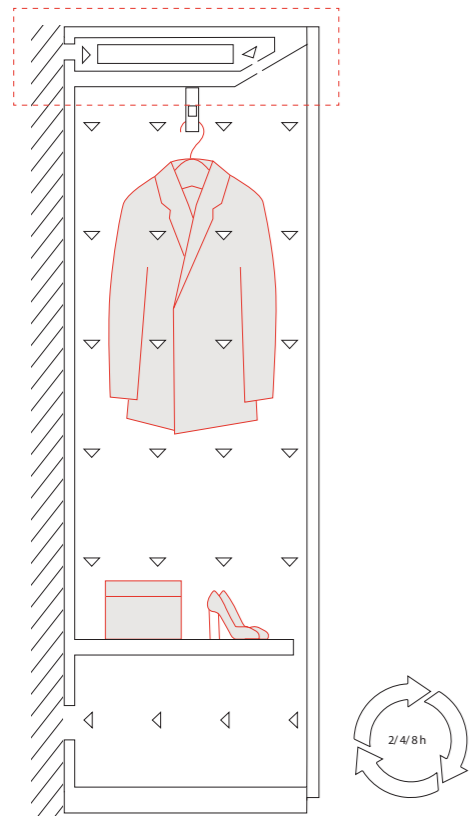

Sezione fianco
Side section

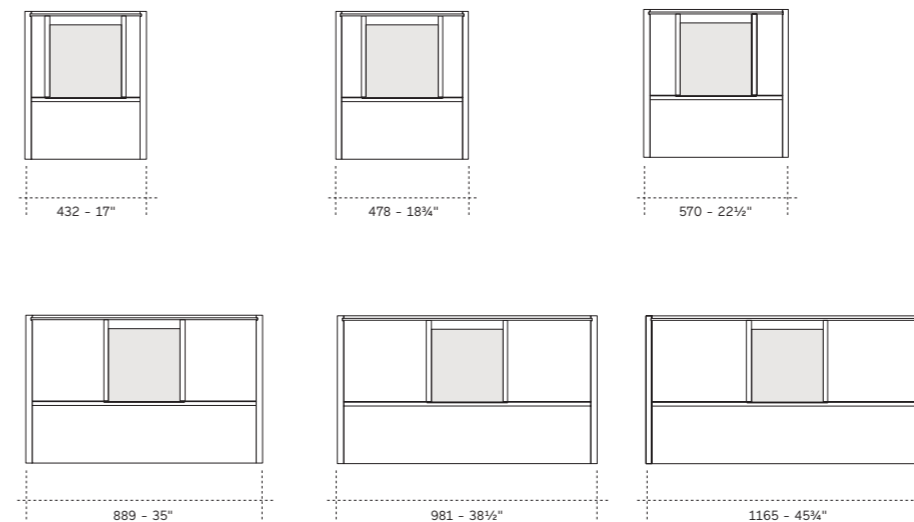

Il dispositivo, esclusivo Lema è coperto da brevetto, attraverso la tecnologia PCO-PX5 di Dust Free (photocatalytic Oxidation 5 noble metals including - meglio conosciuta come ossidazione fotocatalitica e sviluppata per la sanificazione degli ambienti aerospaziali), una volta azionato, grazie all'interazione di una nanotecnologia e di una speciale lampada UV, genera una reazione fotochimica che permette di distruggere con un principio attivo naturale le sostanze inquinanti, batteri e muffe, depurando l'interno dell'armadio e abbattendo fino al 90% i cattivi odori presenti su abiti, scarpe e indumenti riposti

Using Dust Free PCO-PX5 technology (photocatalytic Oxidation 5 including noble metals, originally developed for the sanification of aerospace environments) and through the interaction of nanotechnology and a special UV lamp, this exclusive and patented system generates a photochemical reaction that naturally destroy pollutants, bacteria and mold, purifying the inside of the wardrobe and eliminating up to 90% of unpleasant odours emanating from the stored clothing and footwear

Lema Air Cleaning System

Disponibile per anta battente, scorrevole (solo anta interna) e coplanare. I vani sono riducibili fino alla larghezza minima 432. Il dispositivo è indipendente e comandato da un interruttore posto sul fianco dell'armadio

Available with hinged door, sliding door (internal door only) and coplanar door. Compartments can be reduced in size down to a minimum width of 432. Device is freestanding and controlled by a switch positioned on the side of the wardrobe

Larghezza Width

Profondità fianco 586:
432 - 478 - 570 - 889 - 981 - 1165

For column width 586:
17" - 18 3/4" - 22 1/2" - 35" - 38 1/2" - 45 3/4"

Profondità fianco 442:
889 - 981 - 1165

For column width 442:
35" - 38 1/2" - 45 3/4"

Altezza Height

110 - 4 1/4"

Finiture Finishings

Diffusore in metallo verniciato:
bronzo epox M421
sand epox M455

Diffuser finishings available in metal painted sand M455 or bronze epox M421

Nota Note











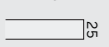

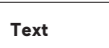
Il ripiano collegato al diffusore è disponibile con o senza lampada "stripe"

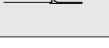
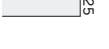





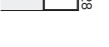



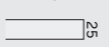

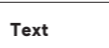
The shelf connected to the diffuser is available with or without "stripe" lamp

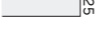

Abaco tipologico ante battenti



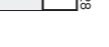



Abacus hinged door types

ante battenti	larghezze			altezze				tipologie			riduzioni			cerniere				
	454 - 17¼"	500 - 19¾"	592 - 23¼"	2014 - 79¼"	2334 - 92" <small>NEW</small>	2430 - 95¾"	2590 - 102"	2846 - 112"	angolare	terminale	sovrapposto	altezza	larghezza	taglio inclinato	94°	Dandy 120°	165°	Dandy 180° <small>NEW</small>
Prima <small>NEW</small> 	•	•	•	•	•	•	•	•	•	•	•	•	•	•	•	•	•	
Flago 	•	•	•		•	•	•	•	•		•	•	•	•			•	
Text 	•	•	•		•	•	•	•	•	•	•	•		•		•		
Next <small>NEW</small> 	•	•	•		•	•	•	•	•		•	•	•	•		•		
Elegant 	•	•	•		•	•	•	•	•	<small>NEW</small>	•	•	<small>NEW</small>	•		•		
Kyn 	•	•	•		•	•	•	•	•	<small>NEW</small>	•	•		•		•		
Ellevi 	•	•	<small>NEW</small>		•	•	•	<small>NEW</small>	•	<small>NEW</small>	•	•	<small>NEW</small>	•		•		
Naica 	•	•	<small>NEW</small>		•	•	•	<small>NEW</small>	•		•	•		•		•		
Nur 	•	•	•		•	•	•	•	•		•	•		•		•		
Nur 	•	•	•		•	•	•	•	•		•	•		•		•		
Emery 	•	•	•		•	•	•		•	<small>NEW</small>	•	•		•		•		
Dandy 	•	•	•		•	•	•	•	•		•	•			•		•	
Warm 	•	•	•		•	•	•	•	•					•		•		
Seryasse 	•	•	•		•	•	•				•			•		•		

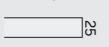

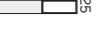

hinged doors	width			height				types			reductions			hinges				
	454 - 17¼"	500 - 19¾"	592 - 23¼"	2014 - 79¼"	2334 - 92" <small>NEW</small>	2430 - 95¾"	2590 - 102"	2846 - 112"	corner	end	additional ward	height	width	tilted cut	94°	Dandy 120°	165°	Dandy 180° <small>NEW</small>
Prima <small>NEW</small> 	•	•	•	•	•	•	•	•	•	•	•	•	•	•	•	•	•	
Flago 	•	•	•		•	•	•	•	•	•		•	•	•	•		•	
Text 	•	•	•		•	•	•	•	•	•	•	•	•		•		•	
Next <small>NEW</small> 	•	•	•		•	•	•	•	•	•		•	•	•	•		•	
Elegant 	•	•	•		•	•	•	•	•	<small>NEW</small>		•	•	<small>NEW</small>	•		•	
Kyn 	•	•	•		•	•	•	•	•	<small>NEW</small>		•	•		•		•	
Ellevi 	•	•	<small>NEW</small>		•	•	•	<small>NEW</small>	•	<small>NEW</small>		•	•	<small>NEW</small>	•		•	
Naica 	•	•	<small>NEW</small>		•	•	•	<small>NEW</small>	•			•	•		•		•	
Nur 	•	•	•		•	•	•	•	•			•	•		•		•	
Nur 	•	•	•		•	•	•	•	•			•	•		•		•	
Emery 	•	•	•		•	•	•		•	<small>NEW</small>		•	•		•		•	
Dandy 	•	•	•		•	•	•	•	•			•	•			•		•
Warm 	•	•	•		•	•	•	•	•						•		•	
Seryasse 	•	•	•		•	•	•					•			•		•	

Abaco tipologico ante scorrevoli

Abacus sliding door types

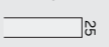
ante scorrevoli	larghezze					altezze				riduzioni	
	750 - 29½"	932 - 36¾"	1024 - 40¼"	1208 - 47½"	1482 - 58¼"	2334 - 92" ^{NEW}	2430 - 95¾"	2590 - 102"	2846 - 112"	altezza	larghezza
Prima 	•	•	•	•	•	•	•	•	•	•	■
Text 	•	•	•	•	•	•	•	•	•	•	■
Ellevi 	•	•	• ^{NEW}	•	•	•	•	•	• ^{NEW}	•	■
Naica ^{NEW} 	•	•	•	•	•	•	•	•		•	■
Emery 	•	•	•	•	•	•	•	•		•	■
Warm 	•	•	• ^{NEW}	•		•	•	•			

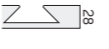
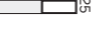





■ possibile riduzione in larghezza fino a mm. 750



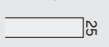



sliding doors	width					height				reductions	
	750 - 29½"	932 - 36¾"	1024 - 40¼"	1208 - 47½"	1482 - 58¼"	2334 - 92" ^{NEW}	2430 - 95¾"	2590 - 102"	2846 - 112"	height	width
Prima 	•	•	•	•	•	•	•	•	•	•	■
Text 	•	•	•	•	•	•	•	•	•	•	■
Ellevi 	•	•	• ^{NEW}	•	•	•	•	•	• ^{NEW}	•	■
Naica ^{NEW} 	•	•	•	•	•	•	•	•		•	■
Emery 	•	•	•	•		•	•	•		•	■
Warm 	•	•	• ^{NEW}	•		•	•	•			

■ width can be reduced down to mm 750

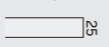
Abaco tipologico ante complanari









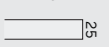

Abacus coplanar door types

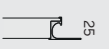
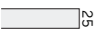





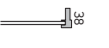

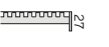

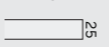
ante complanari	larghezze				altezze			riduzioni	
	908 - 35¼"	1000 - 39¼" ^{NEW}	1184 - 46½"	1458 - 57½"	2334 - 92" ^{NEW}	2430 - 95¾"	2590 - 102"	altezza	larghezza
Prima ^{NEW} 	•	•	•	•	•	•	•	•	
Text 	•	•	•	•	•	•	•	•	
Ellevi 	•	•	•	•	•	•	•	•	
Naica 	• ^{NEW}	•	•	•	•	•	•	•	
Emery ^{NEW} 	•	•	•		•	•	•	•	
Warm 	•	•	•		•	•	•		

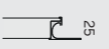
complanar doors	width				height			reductions	
	908 - 35¼"	1000 - 39¼" ^{NEW}	1184 - 46½"	1458 - 57½"	2334 - 92" ^{NEW}	2430 - 95¾"	2590 - 102"	height	width
Prima ^{NEW} 	•	•	•	•	•	•	•	•	
Text 	•	•	•	•	•	•	•	•	
Ellevi 	•	•	•	•	•	•	•	•	
Naica 	• ^{NEW}	•	•	•	•	•	•	•	
Emery ^{NEW} 	•	•	•		•	•	•	•	
Warm 	•	•	•		•	•	•		

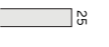
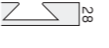
Abaco finiture ante battenti



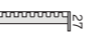

Abacus hinged door finishings



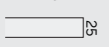

ante battenti	melaminico ^{NEW}	laccato opaco lct	laccato lucido lcl	essenza rovere carbone	essenza rovere termotrattato	essenza rovere grigio	essenza noce-1 ^{NEW}	noce canaletto a doghe	vetro trasparente	vetro fumè grigio ^{NEW}	vetro bronzo riflettente	vetro bronzo serigrafia tessuto	vetro laccato	vetro acidato retrolaccato	specchio	specchio bronzo ^{NEW}	tessuto/pelle ^{NEW}	rivestimento decorativo tessile	cuoio light	argilla		
Prima ^{NEW} 	•	•	•	•	•		•															
Flago 	•	•	•	•	•		•															
Text 	•	•	•	• ^{NEW}	•		•														•	
Next ^{NEW} 	•	•		•	•		•															
Elegant 		•	•																			
Kyn 		•		• ^{NEW}	•	• ^{NEW}	•															
Ellevi 		•	•																			
Naica 		•		• ^{NEW}	•		•															
Nur 												•			•							
Nur 																	•					
Emery 												• ^{NEW}	•	•	•	•						
Dandy 								•	•	•	•	•	•	•	• ^{NEW}	•		•	•			
Warm 																			•			
Seryasse 																			•			

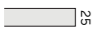
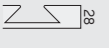
hinged doors	melamine ^{NEW}	laccato opaco lct	laccato lucido lcl	wood carbone oak	wood heat-treated oak	wood grey oak	wood walnut-L ^{NEW}	canaletto walnut in slats	transparent glass	grey smoke glass ^{NEW}	reflecting bronze glass	glass bronze with fabric serigraphy	lacquered glass	acid-etched back-painted glass	mirror	bronze mirror ^{NEW}	fabric/leather ^{NEW}	decorative fabric cover	light hide	clay		
Prima ^{NEW} 	•	•	•	•	•		•															
Flago 	•	•	•	•	•		•															
Text 	•	•	•	• ^{NEW}	•		•														•	
Next ^{NEW} 	•	•		•	•		•															
Elegant 		•	•																			
Kyn 		•		• ^{NEW}	•	• ^{NEW}	•															
Ellevi 		•	•																			
Naica 		•		• ^{NEW}	•		•															
Nur 													•		•	•						
Nur 																	•					
Emery 												• ^{NEW}	•	•	•	•						
Dandy 									•	•	•	•	•	•	• ^{NEW}	•		•	•			
Warm 																				•		
Seryasse 																						

Abaco finiture ante scorrevoli

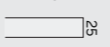

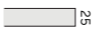
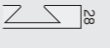



Abacus sliding door finishings



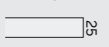

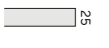

ante scorrevoli	melaminico ^{NEW}	laccato opaco lct	laccato lucido lcl	essenza rovere carbone ^{NEW}	essenza rovere termotrattato	essenza noce- ^{NEW}	vetro laccato	vetro acidato retrolaccato	specchio	specchio bronzo ^{NEW}	cuoio light
Prima ^{NEW} 	•	•	•	•	•	•					
Text 	•	•	•	•	•	•					
Ellevi 		•	•								
Naica ^{NEW} 		•		•	•	•					
Emery 							• ^{NEW}	•	•	•	
Warm 											•

sliding doors	melamine ^{NEW}	laccato opaco lct	laccato lucido lcl	wood carbone oak ^{NEW}	wood heat-treated oak	wood walnut-L ^{NEW}	lacquered glass	acid-etched back-painted glass	mirror	bronze mirror ^{NEW}	light hide
Prima ^{NEW} 	•	•	•	•	•	•					
Text 	•	•	•	•	•	•					
Ellevi 		•	•								
Naica ^{NEW} 		•		•	•	•					
Emery 							• ^{NEW}	•	•	•	
Warm 											•

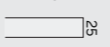
Abaco finiture ante complanari

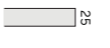
Abacus coplanar door finishings

ante complanari	melaminico ^{NEW}	laccato opaco lct	laccato lucido lcl	essenza rovere carbone ^{NEW}	essenza rovere termotrattato	essenza noce- ^{NEW}	vetro laccato ^{NEW}	vetro acidato retrolaccato ^{NEW}	specchio ^{NEW}	specchio bronzo ^{NEW}	cuoio light
Prima ^{NEW} 	•	•	•	•	•	•					
Text 	•	•	•	•	•	•					
Ellevi 		•	•								
Naica 		•		•	•	•					
Emery ^{NEW} 							•	•	•	•	
Warm 											•

complanar doors	melamine ^{NEW}	laccato opaco lct	laccato lucido lcl	wood carbone oak ^{NEW}	wood heat-treated oak	wood walnut-L ^{NEW}	lacquered glass ^{NEW}	acid-etched back-painted glass ^{NEW}	mirror ^{NEW}	bronze mirror ^{NEW}	light hide
Prima ^{NEW} 	•	•	•	•	•	•					
Text 	•	•	•	•	•	•					
Ellevi 		•	•								
Naica 		•		•	•	•					
Emery ^{NEW} 							•	•	•	•	
Warm 											•

Abaco adattabilità attrezzature ante battenti

Abacus equipment adaptability for hinged doors

ante battenti	larghezze								altezze					profondità		riduzioni		
	432 - 17"	478 - 18¾"	570 - 22½"	889 - 35"	981 - 38½"	1165 - 45¾"	angolare	terminale	2048 - 80¾"	2368 - 93¾"	2464 - 97"	2624 - 103¼"	2880 - 113½"	442 - 17½" NEW	586 - 23	larghezza	altezza	profondità
ripiano comfort	•	•	•	•	•	•	•	•						•	•	•		•
ripiano tech	•	•	•	•	•	•	•							•	•	•		•
ripiano tech con lampada	•	•	•	•	•	•	•							•	•	•		•
ripiano vetro	•	•	•	•	•	•	NEW							•				
ripiano vetro con lampada	•	•	•	•	•	•	NEW							•				
ripiano pelle sintetica	•	•	•	•	•	•	NEW							•				
ripiano pelle sintetica con lampada	•	•	•	•	•	•	NEW							•				
ripiano inclinato portascarpe fisso in legno	•	•	•	•	•	•								•	•			
ripiano inclinato portascarpe fisso in legno con lampada	•	•	•	•	•	•								•	•			
ripiano portascarpe fisso in vetro				•	•	•								•				
ripiano portascarpe fisso in vetro con lampada				•	•	•								•				
griglia portacamicie				•	•	•								•				
barra appendiabiti sezione rettangolare	•	•	•	•	•	•	•							•	•	•		
barra appendiabiti sezione tonda	•	•	•	•	•	•	•							•	•			
vassoio estraibile comfort - tech				•	•	•								•				
portapantaloni estraibile comfort-tech				•	•	•								•				
elemento con vassoio e portapantaloni estraibile comfort-tech				•	•	•								•				
vassoio portascarpe estraibile				•	•	•								•				
portabiancheria estraibile comfort-tech				•	•	•								•				
teca con vassoio estraibile comfort-tech				•	•	•								•				
lampada stripe led	•	•	•	•	•	•	•							•	•	•		
lampada stripe led per fianco								*	•	•	•	•					•	
cassettiere	•	•	•	•	•	•								•	■			▲

hinged doors	width								height					depth		reductions		
	432 - 17"	478 - 18¾"	570 - 22½"	889 - 35"	981 - 38½"	1165 - 45¾"	corner	end	2048 - 80¾"	2368 - 93¾"	2464 - 97"	2624 - 103¼"	2880 - 113½"	442 - 17½" NEW	586 - 23	width	height	depth
comfort shelf	•	•	•	•	•	•	•	•						•	•	•		•
tech shelf	•	•	•	•	•	•	•							•	•	•		•
tech shelf with lamp	•	•	•	•	•	•	•							•	•	•		•
glass shelf	•	•	•	•	•	•	NEW							•				
glass shelf with lamp	•	•	•	•	•	•	NEW							•				
shelf in synthetic leather	•	•	•	•	•	•	NEW							•				
shelf in synthetic leather with lamp	•	•	•	•	•	•	NEW							•				
wooden tilted fixed shoe rack shelf	•	•	•	•	•	•								•	•			
wooden tilted fixed shoe rack shelf with lamp	•	•	•	•	•	•								•	•			
glass fixed shoe rack shelf				•	•	•								•				
glass fixed shoe rack shelf with lamp				•	•	•								•				
shoe rack grille				•	•	•								•				
clothes rail with rectangular section	•	•	•	•	•	•	•							•	•	•		
clothes rail with round section	•		•	•	•	•	•							•	•			
comfort-tech extractable tray				•	•	•								•				
comfort-tech trousers rack				•	•	•								•				
comfort-tech element with extractable trousers rack				•	•	•								•				
extractable shoe rack tray				•	•	•								•				
comfort-tech extractable laundry basket				•	•	•								•				
comfort-tech display case with extractable tray				•	•	•								•				
lamps led strip	•	•	•	•	•	•	•							•	•	•		
lamp led strip for side								*	•	•	•	•	•				•	
chest of drawers	•	•	•	•	•	•								•	■			▲

Abaco adattabilità attrezzature ante scorrevoli

Abacus equipment adaptability for sliding doors

ante scorrevoli	larghezze				altezze				profondità		riduzioni		
	707 - 27¼"	889 - 35"	981 - 38½"	1165 - 45¾"	2368 - 93¼"	2464 - 97"	2624 - 103¼"	2880 - 113½"	442 - 17½"	586 - 23"	larghezza	altezza	profondità
ripiano comfort	•	•	•	•					•	•	•		•
ripiano tech	•	•	•	•					•	•	•		•
ripiano tech con lampada	•	•	•	•					•	•	•		•
ripiano vetro	•	•	•	•						•			
ripiano vetro con lampada	•	•	•	•						•			
ripiano pelle sintetica	•	•	•	•						•			
ripiano pelle sintetica con lampada	•	•	•	•						•			
ripiano inclinato porta-scarpe fisso in legno	•	•	•	•						•			
ripiano inclinato porta-scarpe fisso in legno con lampada	•	•	•	•						•			
ripiano portascarpe fisso in vetro		•	•	•						•			
ripiano portascarpe fisso in vetro con lampada		•	•	•						•			
griglia portacamicie		•	•	•						•			
barra appendiabiti sezione rettangolare	•	•	•	•					•	•	•		
barra appendiabiti sezione tonda	•	•	•	•						•	•		
vassoio estraibile comfort - tech		•	•	•						•			
portapantaloni estraibile comfort-tech		•	•	•						•			
elemento con vassoio e portapantaloni estraibile comfort-tech		•	•	•						•			
vassoio portascarpe estraibile		•	•	•						•			
portabiancheria estraibile comfort-tech		•	•	•						•			
teca con vassoio estraibile comfort-tech		•	•	•						•			
lampada stripe led	•	•	•	•					•	•	•		
lampada stripe led per fianco					•	•	•	•				•	
cassettiere	•	•	•	•						•	■		▲

* non disponibile per fianco telaio
 ■ vedi pag. 218
 ▲ possibile riduzione in profondità fino a 340mm

sliding doors	width				height				depth		reductions		
	707 - 27¼"	889 - 35"	981 - 38½"	1165 - 45¾"	2368 - 93¼"	2464 - 97"	2624 - 103¼"	2880 - 113½"	442 - 17½"	586 - 23"	width	height	depth
comfort shelf	•	•	•	•					•	•	•		•
tech shelf	•	•	•	•					•	•	•		•
tech shelf with lamp	•	•	•	•						•	•		•
glass shelf	•	•	•	•						•			
glass shelf with lamp	•	•	•	•						•			
shelf in synthetic leather	•	•	•	•						•			
shelf in synthetic leather with lamp	•	•	•	•						•			
wooden tilted fixed shoe rack shelf	•	•	•	•						•			
wooden tilted fixed shoe rack shelf with lamp	•	•	•	•						•			
glass fixed shoe rack shelf		•	•	•					•	•			
glass fixed shoe rack shelf with lamp		•	•	•					•	•			
shoe rack grille		•	•	•						•			
clothes rail with rectangular section	•	•	•	•					•	•	•		
clothes rail with round section	•	•	•	•						•	•		
comfort-tech extractable tray		•	•	•						•			
comfort-tech trousers rack		•	•	•						•			
comfort-tech element with extractable trousers rack		•	•	•						•			
extractable shoe rack tray		•	•	•						•			
comfort-tech extractable laundry basket		•	•	•						•			
comfort-tech display case with extractable tray		•	•	•						•			
lamps led strip	•	•	•	•					•	•			
lamp led strip for side					•	•	•	•				•	
chest of drawers	•	•	•	•						•	■		▲

* not available for frame side
 ■ see page 218
 ▲ possible depth reduction up to 340mm

Abaco adattabilità attrezzature ante complanari

Abacus equipment adaptability for coplanar doors

ante complanari	larghezze				altezze			profondità		riduzioni		
	707 - 27¼"	889 - 35"	981 - 38½"	1165 - 45¾"	2368 - 93¼"	2464 - 97"	2624 - 103¼"	442 - 17½" ^{new}	586 - 23"	larghezza	altezza	profondità
ripiano comfort	•	•	•	•				•	•	•		•
ripiano tech	•	•	•	•				•	•	•		•
ripiano tech con lampada	•	•	•	•				•	•	•		•
ripiano vetro	•	•	•	•					•			
ripiano vetro con lampada	•	•	•	•					•			
ripiano pelle sintetica	•	•	•	•					•			
ripiano pelle sintetica con lampada	•	•	•	•					•			
ripiano inclinato porta-scarpe fisso in legno	•	•	•	•				•	•			
ripiano inclinato porta-scarpe fisso in legno con lampada	•	•	•	•				•	•			
ripiano portascarpe fisso in vetro	•	•	•	•					•			
ripiano portascarpe fisso in vetro con lampada		•	•	•					•			
griglia portacamicie	•	•	•	•					•			
barra appendiabiti sezione rettangolare	•	•	•	•				•	•	•		
barra appendiabiti sezione tonda	•	•	•	•					•	•		
vassoio estraibile comfort - tech		•	•	•					•			
portapantaloni estraibile comfort-tech		•	•	•					•			
elemento con vassoio e portapantaloni estraibile comfort-tech		•	•	•					•			
vassoio portascarpe estraibile		•	•	•					•			
portabiancheria estraibile comfort-tech		•	•	•					•			
teca con vassoio estraibile comfort-tech		•	•	•					•			
lampada stripe led	•	•	•	•				•	•	•		
lampada stripe led per fianco					•	•	•				•	
cassettiere	•	•	•	•					•	■		▲

■ vedi pag. 218
▲ possibile riduzione in profondità fino a 340mm

complanar doors	width				height			depth		reductions		
	707 - 27¼"	889 - 35"	981 - 38½"	1165 - 45¾"	2368 - 93¼"	2464 - 97"	2624 - 103¼"	442 - 17½" ^{new}	586 - 23"	width	height	depth
comfort shelf	•	•	•	•				•	•	•		•
tech shelf	•	•	•	•				•	•	•		•
tech shelf with lamp	•	•	•	•					•	•		•
glass shelf	•	•	•	•					•			
glass shelf with lamp	•	•	•	•					•			
shelf in synthetic leather	•	•	•	•					•			
shelf in synthetic leather with lamp	•	•	•	•					•			
wooden tilted fixed shoe rack shelf	•	•	•	•					•			
wooden tilted fixed shoe rack shelf with lamp	•	•	•	•					•			
glass fixed shoe rack shelf	•	•	•	•				•	•			
glass fixed shoe rack shelf with lamp		•	•	•				•	•			
shoe rack grille	•	•	•	•					•			
clothes rail with rectangular section	•	•	•	•				•	•	•		
clothes rail with round section		•	•	•					•	•		
comfort-tech extractable tray		•	•	•					•			
comfort-tech trousers rack		•	•	•					•			
comfort-tech element with extractable trousers rack		•	•	•					•			
extractable shoe rack tray		•	•	•					•			
comfort-tech extractable laundry basket		•	•	•					•			
comfort-tech display case with extractable tray		•	•	•					•			
lamps led strip	•	•	•	•				•	•	•		
lamp led strip for side					•	•	•				•	
chest of drawers	•	•	•	•					•	■		▲

* not available for frame side
■ see page 218
▲ possible depth reduction up to 340mm

Ruled lines for writing on page 270.

Ruled lines for writing on page 271.

Ad+Design **Graph.X**
Photos **Santi Caleca, Thomas Pagani**
Styling **Studio Salaris, Ufficio Stile Lema**
Renderings **Virtual Design S.r.l.**
Translation **way2 global**
Repro + Print **Ogm, 2021**

关注LEMA微信公众号
Follow LEMA WeChat account



公众号 ID : LemaOfficial