

T030 Captures

COLLECTION BOOK
— *number 1*

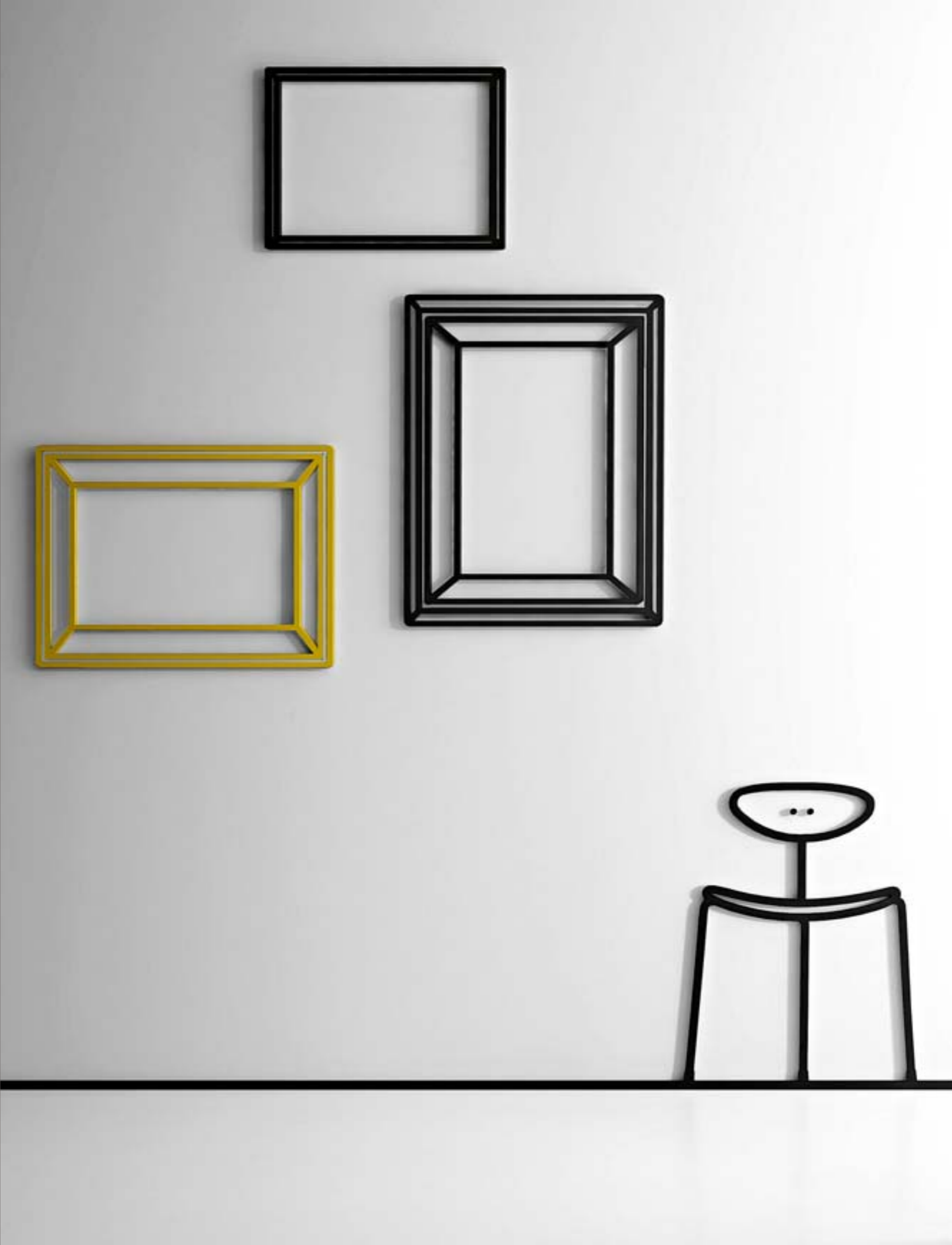



Sommario

— Contents

Composizioni Compositions	04 –63
Informazioni tecniche Technical informations	64 –65
Disegni tecnici Technical drawings	66 –69
Finiture Finishings	70 –71

Introduzione

— Introduction

IT — Versatile, flessibile, sorprendente, creato per tutte le pareti e gli ambienti di casa, T030 è il sistema a parete più adattabile che si possa immaginare. Alla grande varietà di moduli, misure, finiture, si deve la sua capacità di costruire un numero pressoché infinito di combinazioni. Per aiutare chi lo sceglie a progettare le composizioni più accattivanti e funzionali, Lema ha pensato questo strumento: un'agile guida in grado di offrire suggerimenti a seconda delle diverse esigenze e degli usi a cui lo si vuole destinare. Da semplice madia a contenitore di tecnologia, da scaffale leggero per libri e oggetti a parete polifunzionale, da spazio home-working a elegante struttura per dining room: in queste pagine troverete le migliori soluzioni, proposte in diverse finiture, e messe a punto sulla base della grande esperienza di Lema, per cui qualità è sinonimo di rispetto, intelligenza, cura.

EN — Versatile, flexible, surprising and designed for any wall or area of the house, T030 is the most eclectic wall system imaginable with many different units, sizes and finishes that can form countless combinations. To help create alluring and functional compositions, Lema has designed a new tool: a short guide that provides suggestions in response to different requirements and end uses. From the simple sideboard to a multi-media unit, from a light bookcase to a multi-functional equipped wall, from a home working space to an elegant dining room unit, the following pages provide the best solutions in a variety of different finishes, all derived from Lema's considerable experience, where quality is synonymous with respect, intelligence and care.

F — Versatile, flexible, surprenant, dessiné pour meubler toutes les parois et les ambiances de la maison, T030 est le système à équiper les parois les plus adaptable que l'on peut imaginer. De la grande variété de modules, mesures, finitions, dépend la possibilité de réaliser un nombre presque infini de combinaisons. Afin d'aider ceux qui le choisissent à dessiner les compositions les plus captivantes et fonctionnelles, Lema a pensé à un nouveau outil : un simple guide à mesure d'offrir des suggestions selon les différentes exigences et emplois prévus. De la simple huche à un élément multimédia, d'un série d'étagères légères pour livres et objets à une paroi multifonctionnelle, de l'espace bureau maison à une élégante structure pour la salle de séjour : dans les pages suivantes, les meilleurs solutions disponibles, proposées dans de finitions différentes, réalisés sur la base de la grande expérience de Lema, dont qualité signifie respect, intelligence et soin.

D — Flexibel und beeindruckend zeigt sich T030. Dieses für alle Wandeigenschaften und Wohnbereiche entwickelte Schrankwandsystem lässt sich auf unglaublicher Weise anpassen. Die große Auswahl an Elemente, Maße und Ausführungen bieten unzählige Kombinationsmöglichkeiten. Für die Planung von funktionelleren Kompositionen hat Lema an dieses Hilfsmittel gedacht: hier werden Vorschläge entsprechend der unterschiedlichen Ansprüche geboten. Von der einfachen Anrichte zum Hightech-Schrank, vom leichten Bücherregal zur polyfunktionalen Schrankwand, vom Home Working-Bereich zur eleganten Struktur für den Essraum: Auf diesen Seiten finden Sie die besten Lösungsvorschläge, deren Entwicklung auf die große Erfahrung von Lema basiert.

ES — Versátil, flexible y sorprendente, T030 es el sistema de pared más adaptable que se pueda imaginar, y ha sido creado para todas las paredes y los entornos de la casa. Su capacidad de construir un espacio casi infinito de combinaciones se debe a la gran variedad de módulos, medidas y acabados. Lema ha pensado en esta herramienta para ayudar a diseñar a quien lo elige las composiciones más atractivas y funcionales; una guía ágil capaz de ofrecer sugerencias según las distintas exigencias y los usos a los que se quiera destinar. De simple alacena a mueble de almacenaje de equipos tecnológicos, de estante ligero para libros y objetos a pared polifuncional, de espacio home working a estructura elegante para dormitorio: en estas páginas encontrarán las soluciones mejores, que aparecen propuestas con distintos acabados, y puestas a punto en función de la gran experiencia de Lema, para quien la calidad es sinónimo de respeto, inteligencia y cuidado.

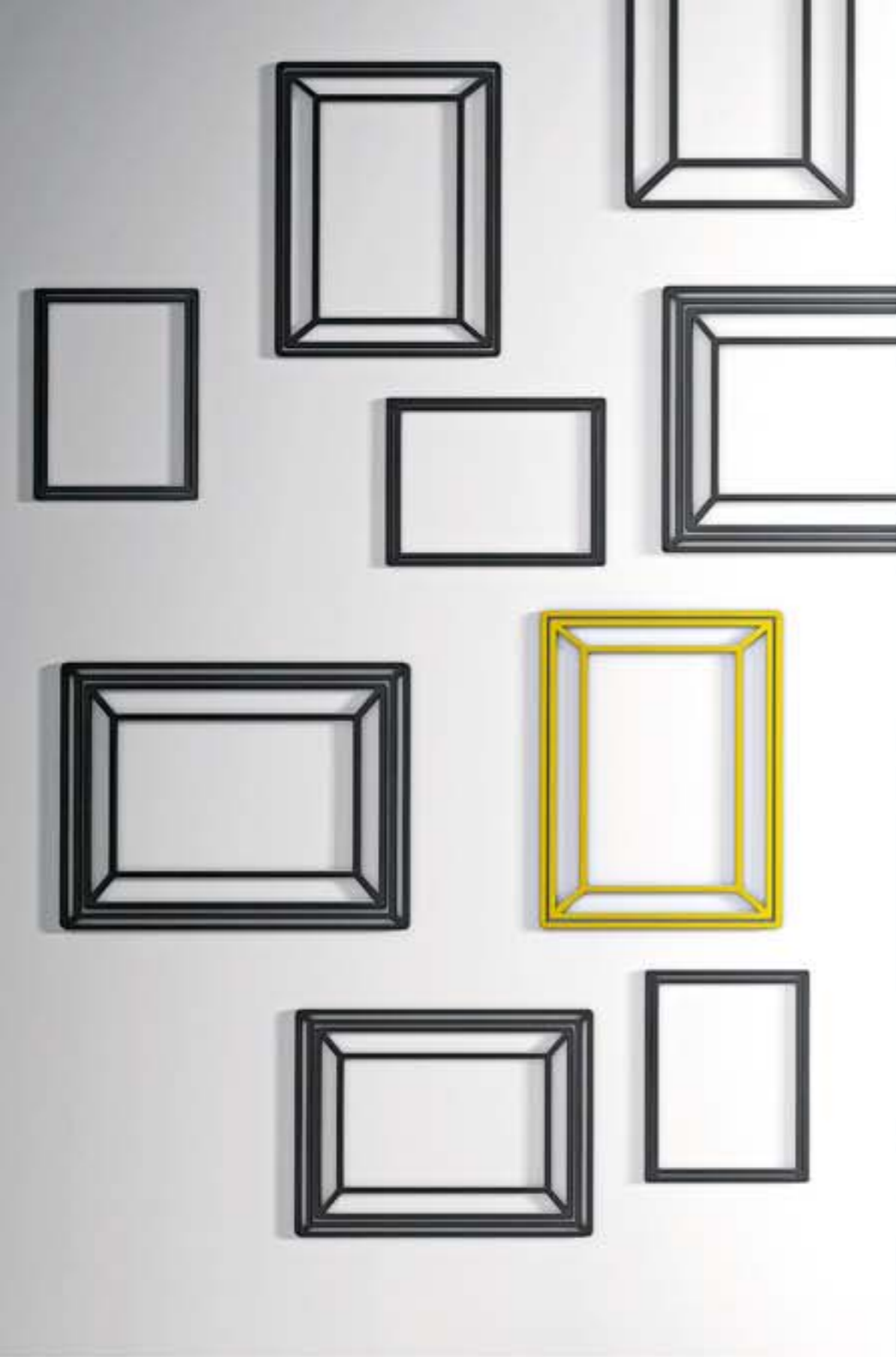



L. 3300 H. 1350 P. 474 W. 130" H. 53¼" D. 18¾" ■ Fumo 906



L. 3300 H. 1350 P. 357 W. 130" H. 53¼" D. 14" ■ Fumo 906



L. 3600 H. 1350 P. 474 W. 141¼" H. 53¼" D. 18¾" ■ Sabbia 910 ■ Felce 226



L. 3600 H. 1350 P. 474 W. 141¼" H. 53¼" D. 18¾" ■ Rovere Carbone





L. 3000 H. 1200 P. 474 W. 118" H. 47¼" D. 18¾" ■ Rovere Carbone ■ Sabbia 910



L. 2400 H. 900 P. 474 W. 94½" H. 35½" D. 18¾" ■ Rovere Carbone ■ Sabbia 910



L. 3900 H. 1200 P. 474 W. 153½" H. 47¼" D. 18¾" ■ Grafite 918 ■ Calcare 801



L. 3900 H. 1200 P. 474 W. 153½" H. 47¼" D. 18¾" □ Carta 750 ■ Avio 476 ■ Rovere Carbone





L. 3000 H. 1200 P. 357 W. 118" H. 47¼" D. 14" Cigno 700 / Bianco 400 Avio 476



L. 3000 H. 1200 P. 357 W. 118" H. 47¼" D. 14" Cigno 700 / Bianco 400 Avio 476



L. 3300 H. 1200 P. 474 W. 130" H. 47¼" D. 18¾" Sabbia 910 Caffè 903



L. 3300 H. 1200 P. 474 W. 130" H. 47¼" D. 18¾" Cigno 700 / Bianco 400 Alga 222





L. 3000 H. 1050 P. 474 W. 118" H. 41¼" D. 18¾" Carta 750 Rovere Carbone



L. 3300 H. 1050 P. 474 W. 130" H. 41¼" D. 18¾" Ginger 474 Sabbia 910



L. 3000 H. 1200 P. 474 W. 118" H. 47¼" D. 18¾" Carta 750 Rovere Carbone

* Composizioni realizzate con Box 2013

* Composition created with Box 2013



L. 3300 H. 1050 P. 474 W. 130" H. 41¼" D. 18¾" Rovere Carbone Cigno 700 / Bianco 400





L. 3000 H. 750 P. 357 W. 118" H. 29½" D. 14" Carta 750 Rovere Carbone



L. 2400 H. 750 P. 357 W. 94½" H. 29½" D. 14" Antimonio 870 Kaki 839



L. 1800 H. 750 P. 357 W. 70¼" H. 29½" D. 14" Carta 750 Rovere Carbone



L. 2400 H. 750 P. 357 W. 94½" H. 29½" D. 14" Grigio 205 Carta 750





L. 1800 H. 1200 P. 357 W. 70¼" H. 47¼" D. 14" ■ Rovere Carbone



L. 1500 H. 1500 P. 357 W. 59" H. 59" D. 14" ■ Rovere Carbone



L. 3600 H. 1220 P. 357 W. 141¾" H. 48" D. 14" □ Cigno 700 / Bianca 400 ■ Oceano 855



L. 3600 H. 1220 P. 357 W. 141¾" H. 48" D. 14" ■ Rovere Carbone ■ Avio 476

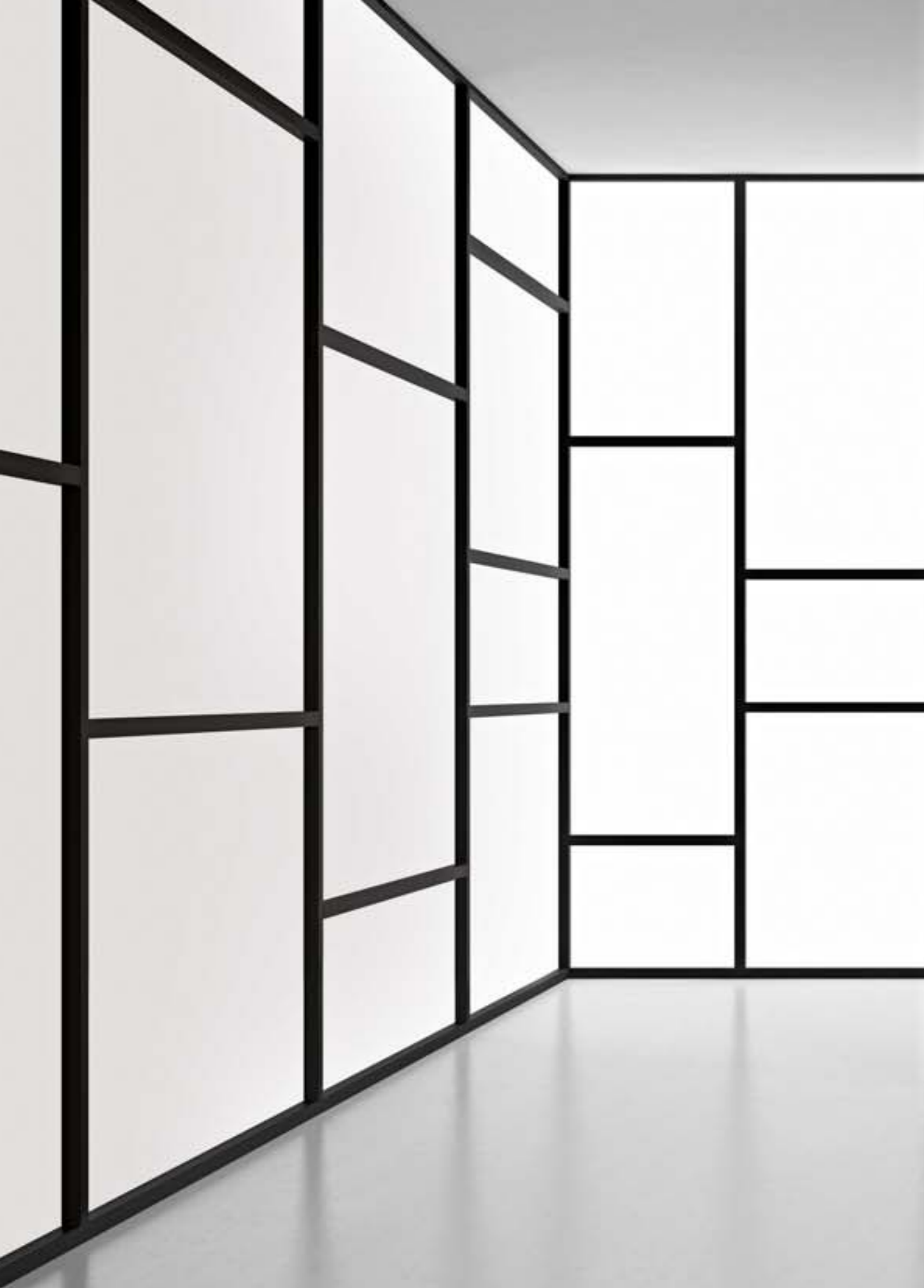



L. 900 H. 1200 P. 357 W. 35½" H. 47¼" D. 14" □ Carta 750

* Composizioni realizzate con Box 2013

* Composition created with Box 2013



L. 1200 H. 1200 P. 357 W. 47¼" H. 47¼" D. 14" □ Carta 750

* Composizioni realizzate con Box 2013

* Composition created with Box 2013



L. 2400 H. 900 P. 354 W. 94½" H. 35½" D. 14" ■ Antimonio 870 ■ Oceano 855



L. 2400 H. 900 P. 354 W. 94½" H. 35½" D. 14" ■ Rovere Carbone ■ Avio 476





L. 2100 H. 800 P. 357 W. 82¾" H. 31½" D. 14" □ Carta 750 □ Paper 227



L. 2100 H. 300 P. 357 W. 82¾" H. 11¾" D. 14" □ Cigno 700 / Bianco 400 ■ Fango 471



L. 2550 H. 600 P. 357 W. 100½" H. 23½" D. 14" □ Carta 750 □ Paper 227



L. 2100 H. 300 P. 357 W. 82¾" H. 11¾" D. 14" ■ Rovere Carbone





L. 2550 H. 920 P. 574 W. 100½" H. 36¼" D. 22½" ■ Rovere Carbone



L. 1800 H. 900 P. 357 W. 70¾" H. 35½" D. 14" ■ Rovere Carbone



L. 1650 H. 1650 P. 357 W. 65" H. 65" D. 14" ■ Antimonio 870 ■ Senape 462



L. 1650 H. 1650 P. 357 W. 65" H. 65" D. 14" ■ Platino 873 ■ Rovere Carbone





L. 3000 H. 900 P. 574 W. 118" H. 35½" D. 22¾" ■ Senape 462



L. 2400 H. 1866 P. 490 W. 94½" H. 73½" D. 19¼" ■ Senape 462



L. 3300 H. 1920 P. 474 W. 130" H. 75½" D. 18¾" ■ Avio 476



L. 3300 H. 1920 P. 474 W. 130" H. 75½" D. 18¾" □ Carta 750 ■ Rovere Carbone



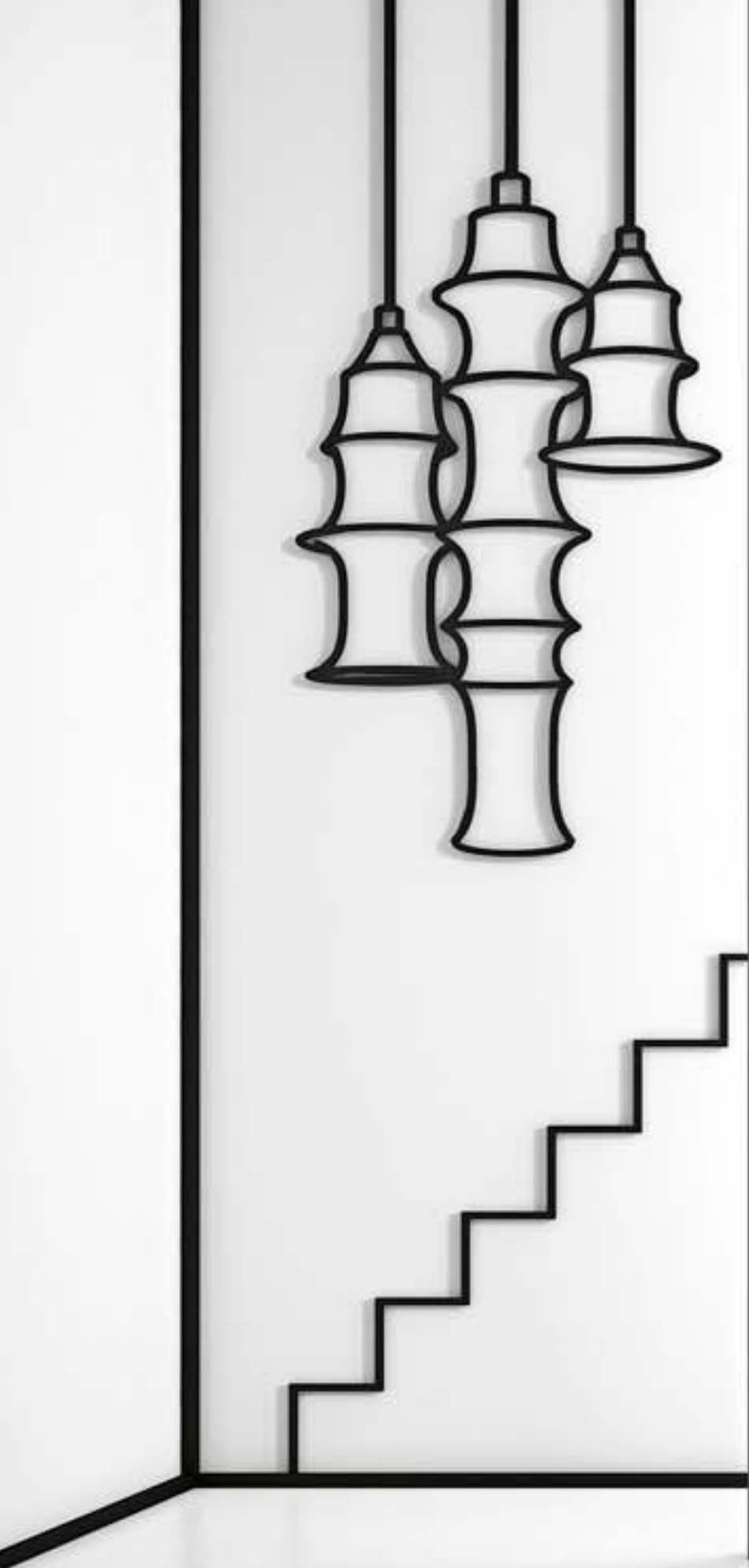



L. 3600 H. 1820 P. 474 W. 141¼" H. 71½" D. 18¾" □ Carta 750 ■ Oceano 855



L. 3600 H. 1520 P. 574 W. 141¼" H. 59¾" D. 22¾" □ Latte 405 ■ Fango 471



L. 3000 H. 1520 P. 574 W. 118" H. 59¾" D. 22½" □ Carta 750 ■ Oceano 855



L. 3600 H. 1520 P. 574 W. 141¼" H. 59¾" D. 22¾" □ Sabbia 910 ■ Kiwi 470





L. 3000 H. 1220 P. 574 W. 118" H. 48" D. 22¾" ■ Antimonio 870 ■ Rovere Carbone



L. 3300 H. 920 P. 474 W. 130" H. 36¼" D. 18¾" ■ Antimonio 870 ■ Rovere Carbone



L. 3900 H. 1350 P. 474 W. 153½" H. 53¼" D. 18¾" ■ Fumo 906 ■ Girasole 229



L. 3900 H. 1350 P. 474 W. 153½" H. 53¼" D. 18¾" □ Paper 227 ■ Bruciato 477





L. 3600 H. 900 P. 357 W. 141¾" H. 35½" D. 14" Sabbia 910 Grigio 205



L. 3000 H. 1100 P. 357 W. 118" H. 43¾" D. 14" Sabbia 910 Grigio 205



L. 4800 H. 1200 P. 357 W. 189" H. 47¼" D. 14" Cigno 700 / 400 Bianco Rovere Carbone



L. 4800 H. 1200 P. 357 W. 189" H. 47¼" D. 14" Lavagna 713 Paper 227





L. 1800 H. 2100 P. 357 W. 70¼" H. 82¾" D. 14" Carta 750 Paper 227



L. 2700 H. 900 P. 357 W. 106¼" H. 35½" D. 14" Carta 750 Paper 227



L. 4800 H. 1200 P. 357 W. 189" H. 47¼" D. 14" Carta 750 Kaki 470



L. 4800 H. 1200 P. 357 W. 189" H. 47¼" D. 14" Rovere Carbone Avio 476





L. 3600 H. 1200 P. 490 W. 141¾" H. 47¼" D. 19¼" Latte 405 Grafite 918



L. 3000 H. 1260 P. 610 W. 118" H. 49½" D. 24" Rovere Carbone Senape 462



L. 3000 H. 1260 P. 610 W. 118" H. 49½" D. 24" Latte 405 Grafite 918



L. 3000 H. 1260 P. 610 W. 118" H. 49½" D. 24" Platino 873 Felce 226

Informazioni tecniche

— *Technical information*

Informazioni tecniche Technical informations	64 –65
Disegni tecnici Technical drawings	66 –69
Finiture Finishings	70 –71

IT __ T030 è un sistema ultraflessibile per la gamma di misure, finiture, moduli che offre. Dispone di tre tipologie di contenitori, chiusi o a giorno: appoggiati a terra, pensili a muro o con zoccoli, in differenti altezze, profondità, larghezze. I contenitori sono dotati, a scelta, di anta battente, ribalta o cassetti, e possono alloggiare applicazioni multimediali. Fanno parte del sistema anche mensole, pannelli e panche appoggiate su contenitori in 2 profondità e 6 larghezze. Per le soluzioni scrittoio e homeworking sono previste panche a penisola, con un lato sempre appoggiato a terra. Svariate le declinazioni di mensole e vani a giorno da combinare ai contenitori. I pannelli da appendere a parete hanno l'interno cavo, per consentire l'accesso a cablaggi tv ed elementi multimediali.

Nel 2013, T030 si è arricchito di box: nuova famiglia di contenitori pensata per velocizzarne la fase progettuale e logistica, renderne più semplice l'installazione e più contenuti i costi. Integrati in una struttura a spessore ridotto, i box offrono diverse configurazioni a parete ad alto impatto grafico. Possono essere appesi o appoggiati a terra, chiusi o a giorno, e realizzati nell'ampia gamma di finiture dell'intero sistema che va dal laccato opaco al lucido, alle essenze, con interni in legno o in laccato opaco nei colori Lemacolortrend.

EN __ T030 is an ultra-flexible system in terms of the sizes, finishes and units available. It offers three types of closed and open units: floor standing, wall-hung or supported by a plinth, all in different heights, depths and widths. The units can be fitted with hinged or flap doors, or drawers and can accommodate multi-media units. Shelves, panels and benches are also available which sit on units in a choice of 2 depths and 6 widths. For desk and home working solutions, peninsula bench units are available, one end of which rests on the floor. A variety of shelves and open units are available to match the containers. Wall panels are hollow to enable TV and multi-media unit cables to pass through.

In 2013, T030 was augmented with containers, a new family of units designed to speed up the project and logistics, facilitate installation and reduce costs. Fitted within a very thin structure, the containers can create a variety of wall configurations to great visual effect. They can be hung on the walls or placed on the floor, they can be closed or open and are available in a wide range of finishes of mat and gloss lacquers and wood, with the interiors in a wood or mat lacquer finish in the Lemacolortrend colours.

F __ T030 est un système ultra-flexible en termes de dimensions, finitions et éléments à disposition. Trois types d'éléments ou fermés: à terre, suspendus à la paroi ou soutenus par plinthes, en hauteurs, profondeurs et largeurs différentes. Les éléments sont fermés, au choix, pardes portes battante, à abattant ou avec des tiroirs et ils peuvent abriter des éléments multimédia. Des tablettes, panneaux et banquettes soutenus par les éléments en deux profondeurs et six largeurs. Pour les solutions bureau et office maison, il y a à disposition des banquettes en péninsule, avec un côté toujours à terre. Un grand nombre de tablettes et d'éléments ouverts à juxtaposer au loisir. Les panneaux à suspendre à la paroi vont présenter l'interno creux, afin de permettre l'accès et le passage des câbles télé et des éléments multimédia.

En 2013, T030 s'est enrichi de box : une nouvelle famille d'éléments réalisée afin de rendre la phase de réalisation du projet plus vite, d'en simplifier l'installation et d'en réduire les coûts. Intégrés dans une structure à épaisseur réduite, les éléments box offrent des configurations à paroi différentes à impacte graphique unique. Il est possible de les suspendre ou de les fixer à terre, fermés ou ouverts, réalisés dans le grand nombre de finitions du système, en laque mate ou brillante, bois, avec les internes en bois ou en laque mate dans les différents coloris de Lemacolortrend.

D __ Das umfangreiche Angebot an Maßen, Ausführungen und Elementen macht T030 zu einem ultraflexiblen System. Es verfügt über drei Schrankversionen, offen oder geschlossen: als Standelement, Hängeelement oder mit Sockeln, in verschiedenen Höhen, Tiefen und Breiten. Die Schränke. Die Schränke lassen sich wahlweise mit Türen, Klapptüren oder Schubladen ausgerüstet werden und bieten Platz für das Mediencenter. Zu diesem System gehören auch Regale, Paneele und Podestelemente in 2 Tiefen und 6 Breiten. Als Schreibtisch und Platz für das Homeworking sind einseitig auf dem Boden gestützte Halbinsel-Podestelemente vorgesehen. Unterschiedliche Ausführungen von Regalen und offenen Fächern für die Kombination mit den Schränken. Die Wandpaneele sind intern für den Kabeldurchlauf der Verkabelung von TV und Multimediaelementen vorgerichtet.

Das Programm T030 wurde 2013 mit Box-Elementen erweitert: eine neue Schrankserie, die dazu dient, die Planung und Logistik zu beschleunigen, die Montage zu erleichtern und die Kosten zu vermindern. Integriert in einer Struktur mit reduzierten Stärken bieten diese Box-Elemente verschiedene bezüglich der Grafik leistungsstarke Wandaufstellungen. Positionierbar als Hänge- oder Standelement, offen oder geschlossen und mit einem umfangreichen Angebot an Ausführungen des gesamten Systems, von Matt- und Glanzlackierungen hin zu den Holzarten und Innenausstattungen aus Holz oder mit Mattlackierungen nach den Musterfarben Lemacolortrend.

ES __ T030 es un sistema ultraflexible por la gama de medidas, acabados y módulos que ofrece. Dispone de tres tipos de muebles de almacenaje, cerrados o a la vista: se apoyan sobre el suelo, cuelgan sobre la pared o llevan zócalos y se presenta con diferentes alturas, profundidades y anchuras. Los muebles de almacenajes están equipados, según se elija, de hoja batiente, abatible o con cajones, y pueden alojar aplicaciones multimedia. También forman parte del sistema estantes, paneles y bancos apoyados sobre los muebles de 2 profundidades y 6 anchuras. Para las soluciones de escritorio y home working están previstas bancos península, como un lado apoyado siempre sobre el suelo. Variados declinaciones de estantes y huecos a la vista que combinar con los muebles. Los paneles para colgar a la pared tienen el interior hueco, para permitir el acceso a los cables de la televisión y los elementos multimedia.

En 2013, T030 se ha enriquecido con box: una nueva familia de muebles de almacenaje concebidos para agilizar la fase de diseño y logística, hacer más sencilla la instalación y los costes más reducidos. Los boxes están integrados en una estructura de espesor reducido y ofrecen varias configuraciones de pared de impacto gráfico alto. Pueden colgarse o apoyarse al suelo, cerrados o a la vista, y realizarse en la amplia gama de acabados del sistema completo que va del lacado mate al brillante, a las maderas, con internos de madera y un lacado mate en los colores Lemacolortrend.

Contenitori a terra
Basic units

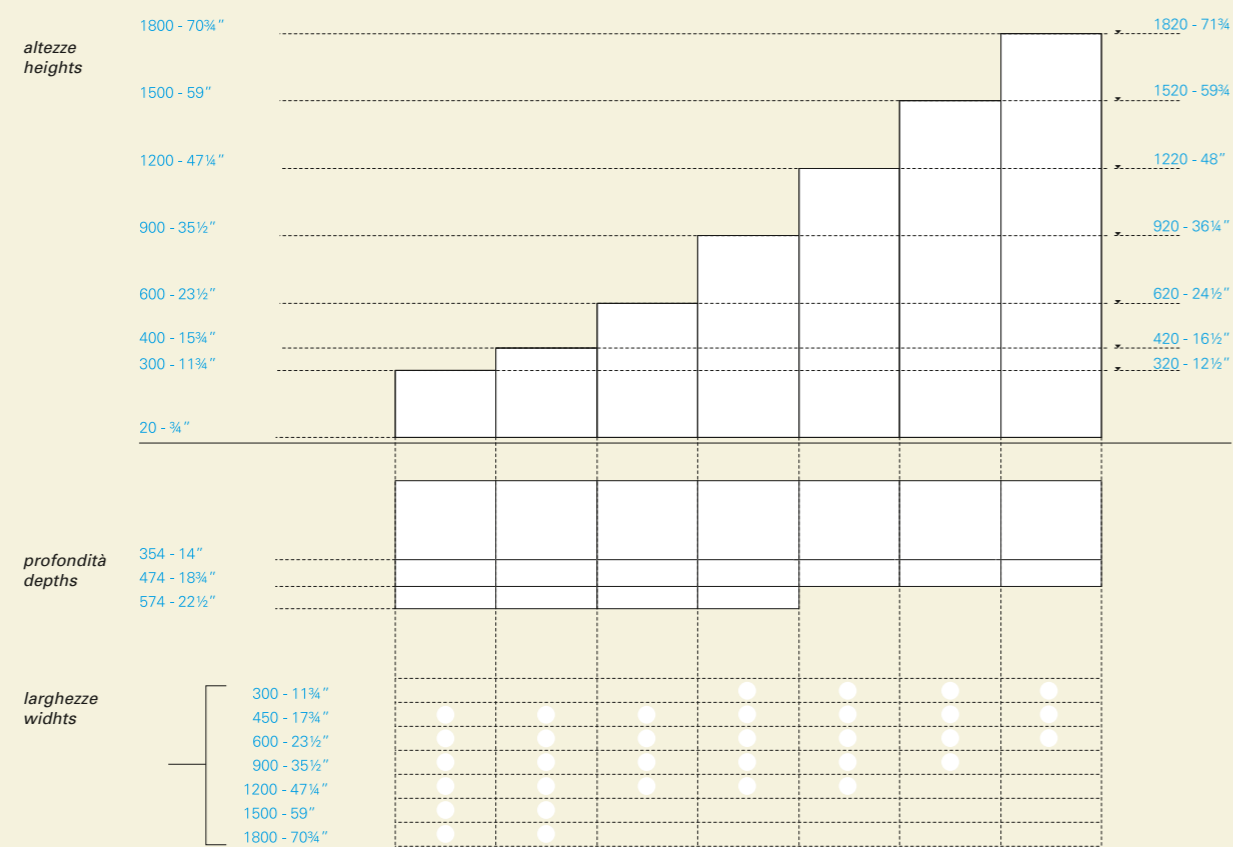

Contenitori pensili
Pensili con zoccolo
Hanging units
Hanging with baseboard

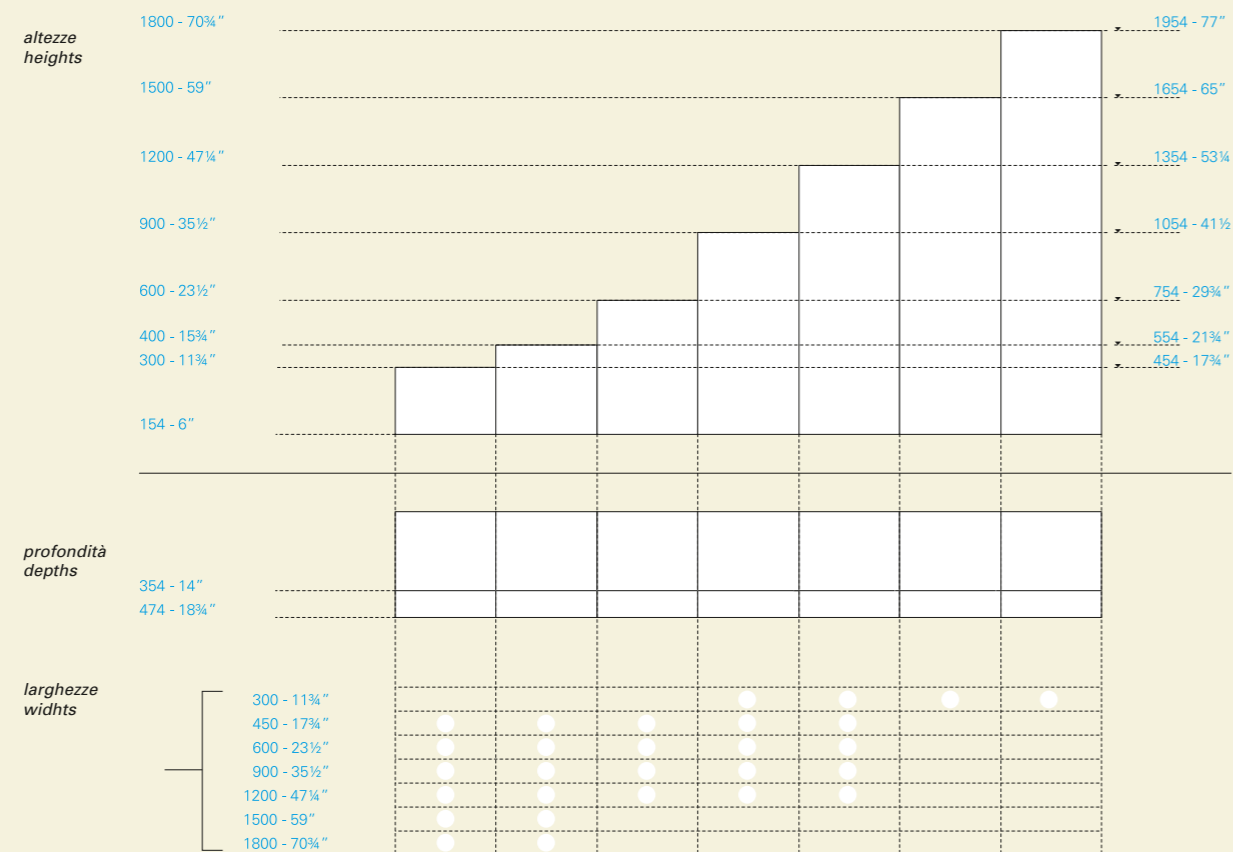

Contenitori a giorno
Open units

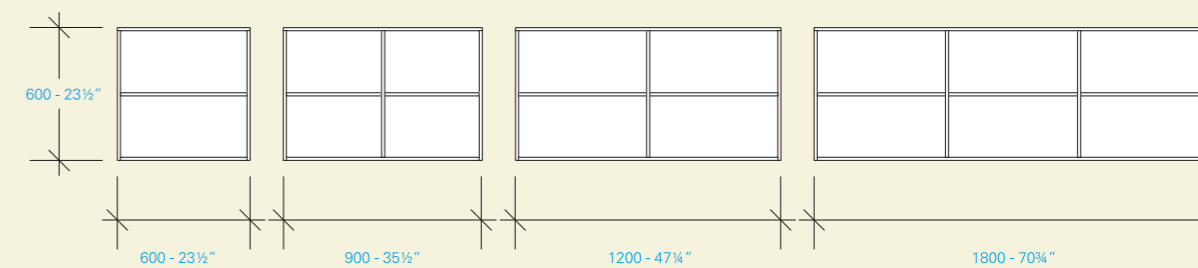

profondità: 400
depth: 15¾"

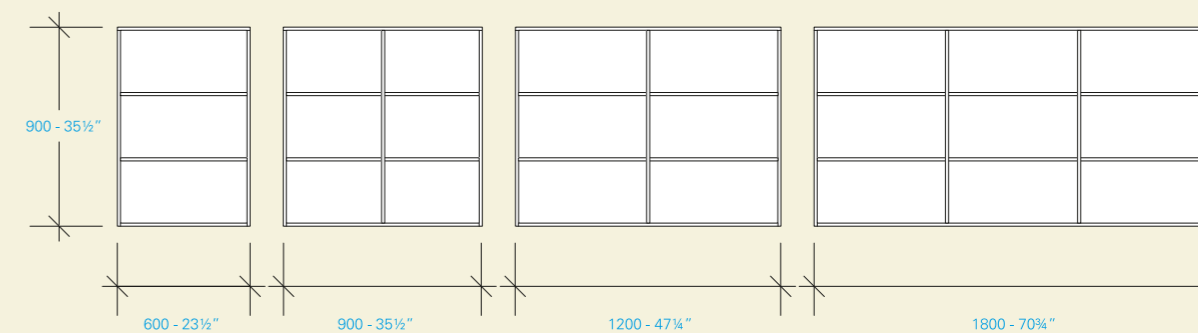

profondità: 400
depth: 15¾"

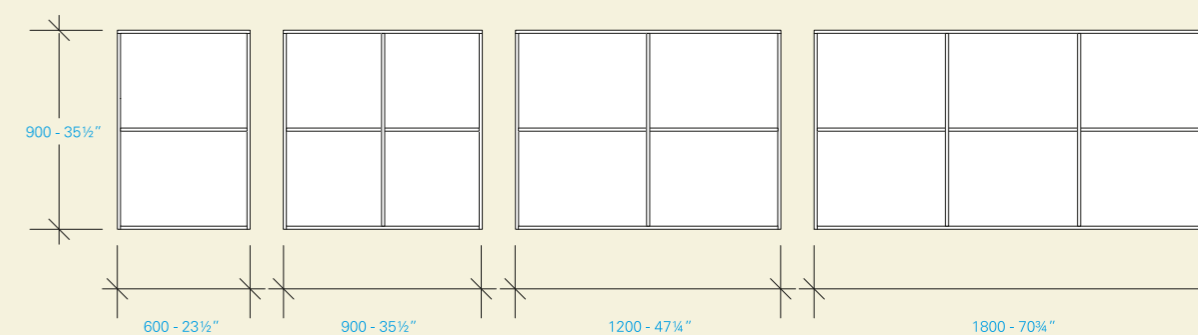

profondità: 400
depth: 15¾"

Zoccoli legno
e Piedini a telaio metallo
Wood Baseboard
and Metal feet

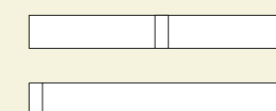

H 154 - 6"

H 154 - 6"

H 154 - 6"

H 154 - 6"

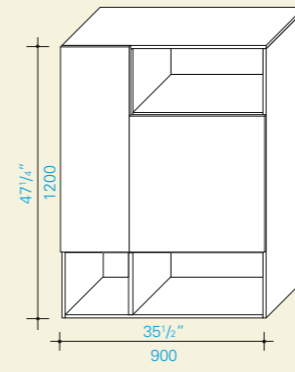
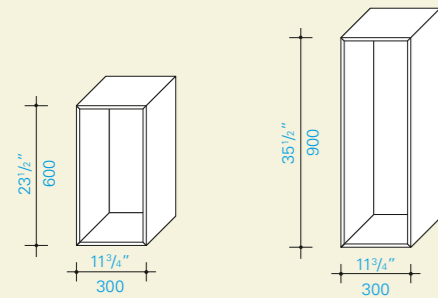
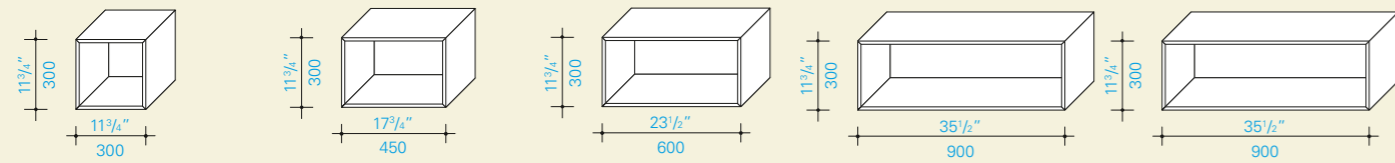
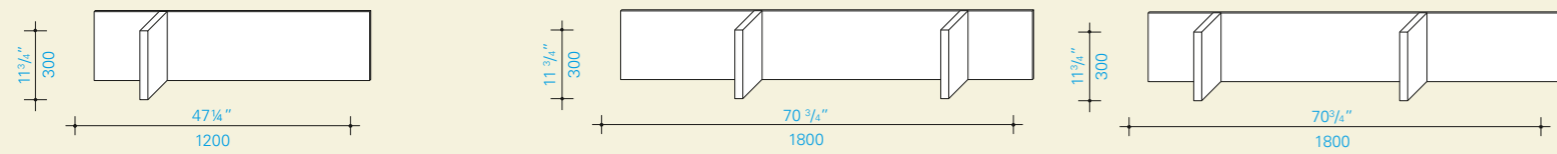
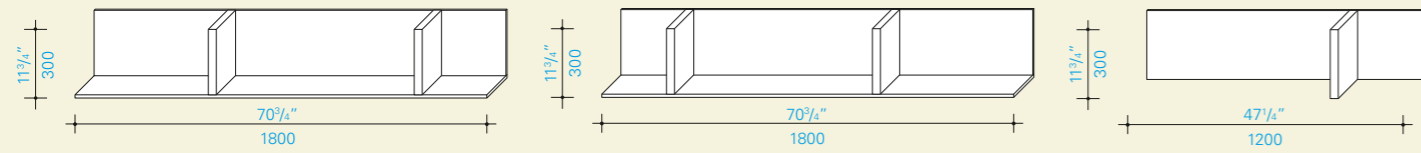
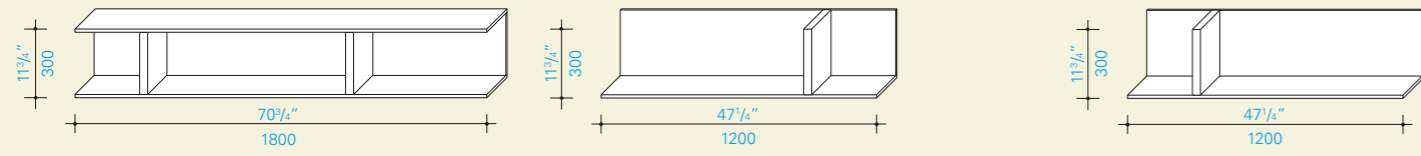
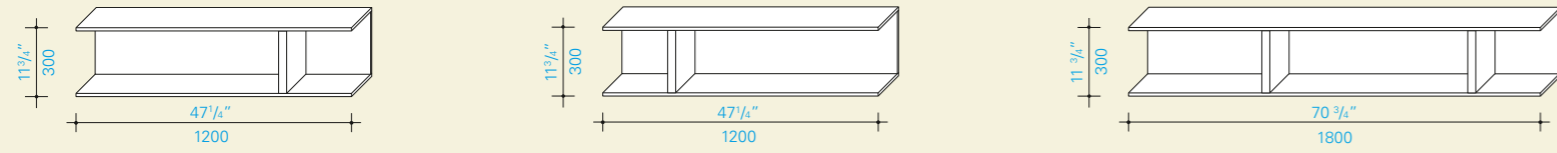

Box A

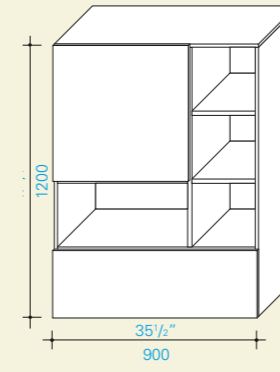

Box B

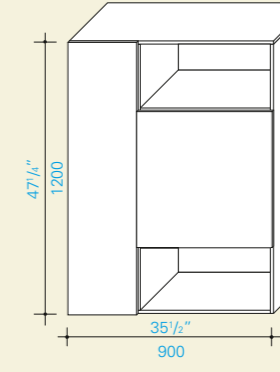

Box C

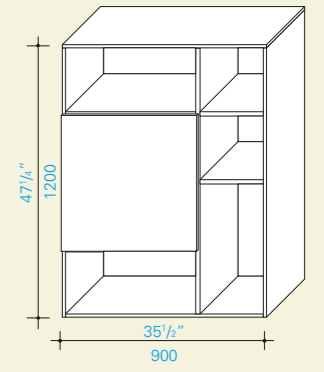

Box D

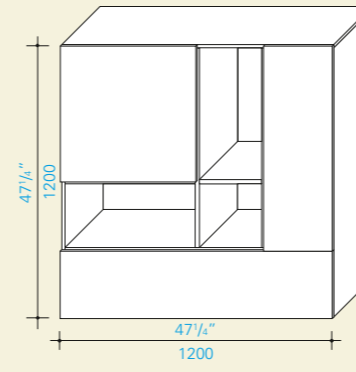

Box E

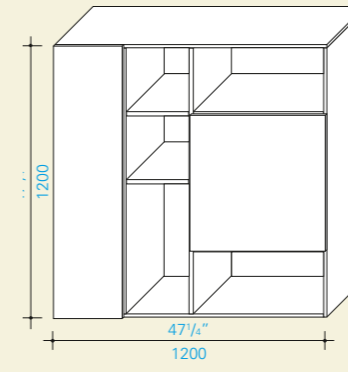

Box F

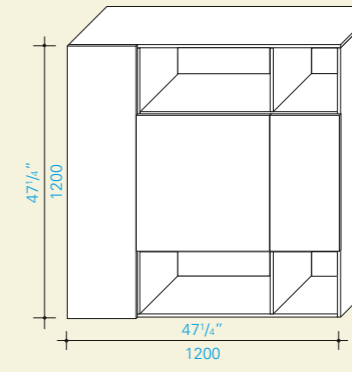

Box G

— Lemacolortrend

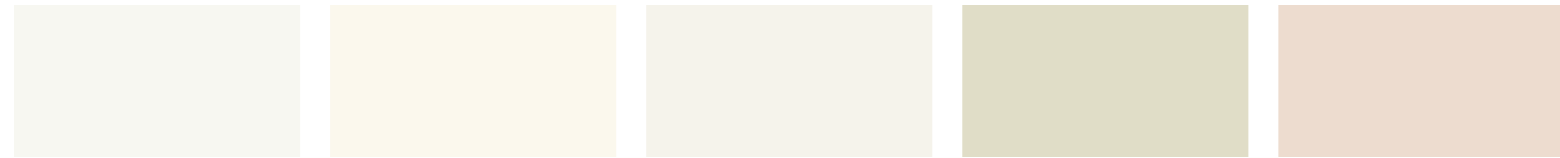

Carta 750 Latte 405 Cigno 700 / Bianco 400 Calcare 801 Cipria 460

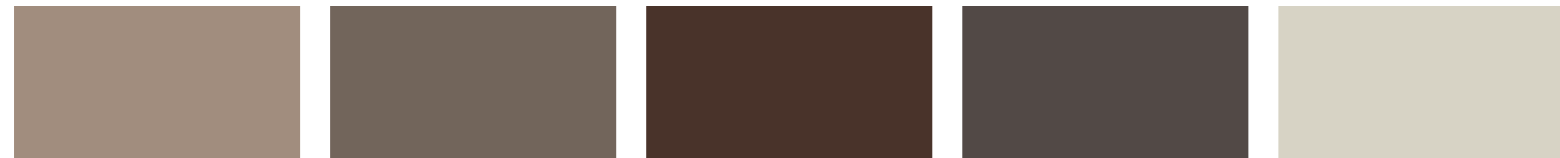

Ombra 803 Cacao 461 Caffé 903 Fumo 906 Sabbia 910



Pomice 905 Grafite 918 Lavagna 713 Platino 873 Antimonio 870



Panna 754 Canapa 707 Banana 810 Paglia 706 Senape 462



Orzo 812 Mandarino 463 Ginger 474 Mango 845 Fucsia 473



Petalo 472 Tulipano 465 Amarena 828 Bruciato 477 Vinaccia 829



Kiwi 470 Prato 475 Kaki 839 Fango 471 Avio 476



Polvere 466 Pavone 467 Ciano 468 Oceano 855 Oltremare 469

— Lemacolorlucido



Paper 227 Bianco 200 Piuma 221 Nocciola 213 Grigio 205



Scoglio 212 Nero 215 Beige 211 Girasole 229 Papaia 228



Ciliegia 216 Bordeaux 220 Felce 226 Alga 222 Oriente 225



Turchino 224 Navy 230



— Legni, woods

Rovere Tabacco Rovere Carbone

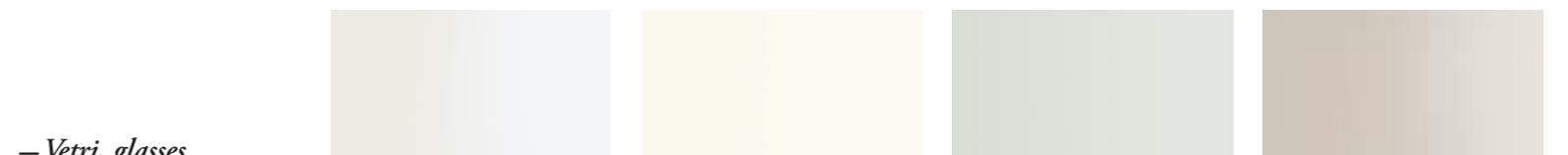

— Vetri, glasses

Bianco Yogurt Perla Avorio



Titanio Tortora Grigio Nero Aragosta



Rosso Bronzo riflettente Riflettente RL

Art direction, design

—*Graph.X*

Renderings

—*It's Alive Studio*

Francesco Pucciarelli
www.itsalive.it

Testi

—*Calamus*

Stampa

—*O.G.M. SpA 2013*

Lema s.p.a.

22040 Alzate Brianza

Como - Italy

Strada Statale

Briantea n°2

t +39.031.630.990

f +39.031.632.492

lemamobili.com

LEMA s.p.a.

22040 Alzate Brianza
Como – Italy
Strada Statale
Briantea n° 2
t +39 031 630 990
f +39 031 632 492
lemamobili.com