

SALONE DEL MOBILE COLLECTION 2024

MERIDIANI
MILANO
DESIGN
WEEK
2024

MERIDIANI

SALONE DEL MOBILE

COLLECTION 2024

design Andrea Parisio

HALL 11
STAND G11 H18
PP. 2, 33

TECHNICAL
INFO

JEANETTE
PP. 34, 35

GINO
PP. 36,37

COSETTE
PP. 38, 39

CLAUDINE
PP. 40, 41

VETRA
PP. 42, 47

ROMEO
PP. 48, 51

WALLIS
PP. 52, 57

JOHNNY
PP. 58, 59

RONNY
PP. 60, 61

TUYO
PP. 62, 63

VINCENT OPEN AIR
PP. 64, 67

BONGO OPEN AIR
PP. 68

FABIEN OPEN AIR
PP. 69

Collection 2024

Soluzioni progettuali a tutto tondo, che danno forma ad arredi completi, per ambienti che valorizzano quella linearità sofisticata in grado di rendere un prodotto puro nella sua essenzialità. La mano del designer e art director Andrea Parisio consegna la collezione 2024, con novità che strizzano l'occhio a un design contemporaneo e dall'appeal originale, fatto di forme morbide, volumi semplici e suggestioni architettoniche.

All-round design solutions that provide complete furnishings, suitable for environments that enhance the sophisticated linearity that makes a product pure in its essential nature. The hand of designer and art director Andrea Parisio delivers the 2024 collection, with novelties that wink at contemporary design with an original appeal, made up of soft shapes, simple volumes, and architectural suggestions.







MERIDIANI MILANO DESIGN WEEK 2024

SALONE DEL MOBILE COLLECTION 2024



NEW.
VETRA



MERIDIANI MILANO DESIGN WEEK 2024

SALONE DEL MOBILE COLLECTION 2024



NEW.
COSETTE,
ROMEO, CLAUDINE





Le nuove proposte continuano a raccontare la storia di un'armonia senza tempo ma in continua evoluzione, esprimendo l'identità di un brand eclettico, che offre sempre rinnovate fonti di ispirazione e spazio per l'interpretazione personale.

NEW.
JEANETTE, ROMEO

NEW.
GINO, FABIEN OPEN AIR









The new proposals continue to tell the story of a timeless yet ever-evolving harmony, while expressing the identity of an eclectic brand that always offers fresh sources of inspiration and room for personal interpretation.

NEW.
WALLIS

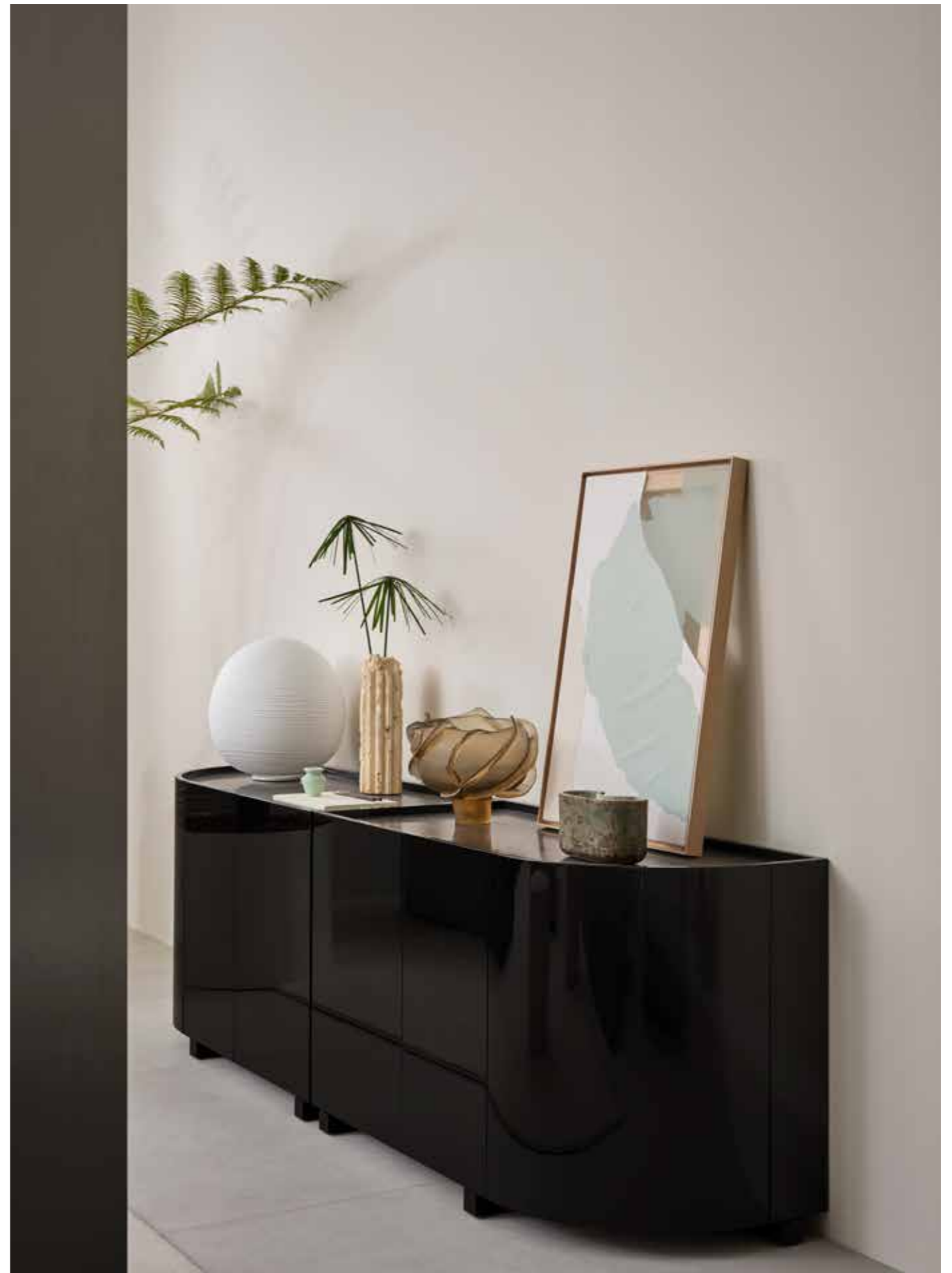



MERIDIANI MILANO DESIGN WEEK 2024

SALONE DEL MOBILE COLLECTION 2024

NEW.
WALLIS,
GINO,
JEANETTE







NEW.
TUYO, JOHNNY

- | | | | |
|-----------|---|-----------|--|
| P. 3 | OSCAR 255 divano . sofa
BELT TB130x80 tavolo basso . low table
BELT METAL TB50 tavoli bassi . low tables | P. 18 | GINO pouf |
| P. 4, 5 | OSCAR 305, 255 divani . sofas
BELT TB130x80 tavolo basso . low table
BELT METAL TB50, TB100 tavoli bassi . low tables
OWEN LOUNGE tavolo . table
BIRK 220 specchio . mirror | P. 19 | FABIEN OPEN AIR 70 tavolo basso . low table
VINCENT OPEN AIR divano componibile . modular sofa |
| P. 6 | OSCAR poltrone . armchairs
BIRK 220 specchio . mirror | P. 20, 21 | NANI poltrona . armchair
GONG 45 tavolo basso . low table
AMADEUS pensile . wall unit
VINCENT OPEN AIR chaise longue ROUND |
| P. 7 | OWEN LOUNGE tavolo . table
COSETTE sedia . chair | P. 22, 23 | ITALO 120x240 tavolo . table
EMILIA sedie . chairs
BACO pouf componibile . modular pouf |
| P. 8 | RENÉ divano componibile . modular sofa
LEON 130 tavolo basso . low table | P. 24 | TERESA poltrone . armchairs
BLAKE TB120 tavolo basso . low table |
| P. 9 | VETRA contenitore componibile . modular storage unit
BOBO 45 tavolo basso . low table | P. 25 | WALLIS QUATTRO contenitori . storage units |
| P. 10, 11 | RENÉ divano componibile . modular sofa
BOBO 45 tavolo basso . low table
LEON 130 tavolo basso . low table
VETRA contenitore componibile . modular storage unit | P. 26, 27 | HAROLD divano componibile . modular sofa
BLAKE TB120 tavolo basso . low table
WALLIS QUATTRO contenitori . storage units
CHARLOT 45R poufs |
| P. 12 | PLINTO ROUND 3W tavolo . table
COSETTE sedie . chairs
HARRIS pensile . wall unit | P. 28 | WALLIS QUATTRO contenitori . storage units |
| P. 13 | CLAUDINE sedia . chair
ROMEO contenitore . storage unit | P. 29 | WALLIS TRE cassettiere . chests of drawers
GINO poufs
BIRK 110R specchio . mirror
JEANETTE poltrona . armchair
BACO pouf componibile . modular pouf |
| P. 14, 15 | MAX divano componibile . modular sofa
ADRIAN 130 tavoli bassi . low tables
JEANETTE poltrone . armchairs
HARDY 150x150 pensili . wall units | P. 30, 31 | TUYO testiera . headboard 370 LOW CURVE BALL
TUYO base 30 200x215 BALL
JOHNNY comodino . night table
JEANETTE poltrona . armchair
BACO pouf componibile . modular pouf |
| P. 16 | JEANETTE poltrone . armchairs
ADRIAN 130 tavolo basso . low table | P. 32 | TUYO testiera . headboard 370 LOW CURVE BALL
TUYO base 30 200x215 BALL
JOHNNY comodino . night table |
| P. 17 | ROMEO 200 contenitore . storage unit | | |

Jeanette

Jeanette è la poltrona dalle morbide forme scultoree. Lo schienale, che si sviluppa attraverso un cilindro avvolgente fino a diventare anche bracciolo, è l'elemento che definisce il tratto distintivo di questo prodotto dal disegno tondo, pieno e dal grande comfort. La sua gamba centrale, in tessuto, laccata o in essenza, è un ulteriore elemento caratterizzante, che richiama l'andamento stondato della scocca posteriore, risultando un dettaglio in grado di fare la differenza in una poltrona che si presta ad abbinamenti personalizzati. Le ridotte dimensioni e la solida struttura rendono Jeanette la seduta perfetta anche per spazi limitati, perfino nella sua versione a divanetto con linee floride ma compatte.

Jeanette is the soft armchair with sculptural shapes, defined by round, full, and comfortable look. The backrest is its focal point, which grows through a wrapping cylinder until it also becomes the armrests. An additional distinctive feature that echoes the circular form of the back is the center leg, which can be made of wood, lacquered, or fabric – a small detail able to make a big difference in an armchair meant for personal configurations. The compact dimension and solid structure make Jeanette the ideal seat even for small spaces, as well as its sofa version with florid yet slim lines.

34, 35

JEANETTE 2024

poltrona - armchair

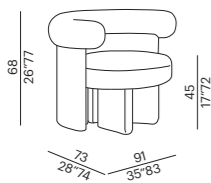

TECHNICAL DETAILS

IT

- poltrona imbottita non sfoderabile in una selezione di tessuti di collezione
- struttura in legno
- imbottiture in poliuretano e fibre poliestere
- gamba centrale in massello di faggio tinto black - laccato opaco/lucido o rivestita in una selezione di tessuti di collezione (stesso tessuto della struttura)

EN

- padded armchair with fixed cover in a selection of Meridiani fabrics
- wooden frame
- padding in polyurethane and polyester fiber
- central leg in solid beech black stained - matt or glossy lacquered - covered in a selection of Meridiani fabrics (same fabric as the frame)

DE

- gepolsterter Sessel mit Festbezug aus einer Auswahl von Meridiani Stoffen
- Holzgestell
- Polsterung aus PU-Schäumen und Polyesterfaser
- Mittelfuß aus massiv Buchenholz black gebeizt - matt/Hochglanz lackiert oder mit Bezug aus einer Auswahl von Meridiani Stoffen (gleicher Stoff wie Gestell)

FR

- fauteuil rembourré non déhoussable dans une sélection des tissus Meridiani
- structure en bois
- rembourrage en polyuréthane et fibre polyester
- pied central en hêtre massif teinté noir - laque mate ou brillante ou dans une sélection des tissus Meridiani (même tissu que la structure)

ES

- butaca acolchada con funda fija en una selección de telas Meridiani
- estructura de madera
- relleno en poliuretano y fibra poliéster
- pata central de haya maciza teñida en negro - lacada mate o brillo - tapizada en una selección de telas Meridiani (misma tela que la estructura)



Gino

Gino è un pouf originale e curioso, appartenente alla famiglia delle sedie Cosette e Claudine. Caratterizzato da una seduta rotonda e da tre gambe cilindriche, disponibili non solo in tessuto o pelle ma anche in legno o laccate, Gino è pratico e funzionale, un complemento sfizioso per qualsiasi angolo della casa.

Gino is an original and quirky pouf from the Cosette and Claudine chair family. Gino is a functional and useful piece with a round seat and three cylindrical legs, available in fabric, leather, wood, or lacquer. A delightful complement to any corner of the house.

36, 37

GINO 2024

poltrona - armchair

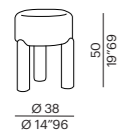

TECHNICAL DETAILS

IT

- pouf imbottito non sfoderabile in una selezione di tessuti di collezione
- struttura in legno
- imbottitura in poliuretano e fibre poliester
- gambe in massello di faggio tinto black. in poliuretano rigido laccato opaco/lucido o rivestite in una selezione di tessuti di collezione (stesso tessuto della struttura)

EN

- padded pouf with fixed cover in a selection of Meridiani fabrics
- wooden frame
- padding in polyurethane and polyester fiber
- legs in solid beech black stained. in rigid polyurethane matt or glossy lacquered - covered in a selection of Meridiani fabrics (same fabric as the frame)

DE

- gepolsterter Hocker mit Festbezug aus einer Auswahl von Meridiani Stoffen
- Holzgestell
- Polsterung aus PU-Schäumen und Polyesterfaser
- Füße aus massiv Buchenholz black gebeizt. aus hartem Polyurethan matt/Hochglanz lackiert oder mit Bezug aus einer Auswahl von Meridiani Stoffen (gleicher Stoff wie Gestell)

FR

- pouf rembourré non déhoussable dans une sélection des tissus Meridiani
- structure en bois
- embouillage en polyuréthane et fibre polyester
- pieds en hêtre massif teinté noir. en polyuréthane rigide laque mate ou brillante ou dans une sélection des tissus Meridiani (même tissu que la structure)

ES

- pouf acolchado con funda fija en una selección de telas Meridiani
- estructura de madera
- relleno en poliuretano y fibra poliéster
- patas de haya maciza teñida en negro. de poliuretano rígido lacadas mate o brillo - tapizadas en una selección de telas Meridiani (misma tela que la estructura)



Cosette

Cosette è una sedia dalla silhouette slanciata e dai volumi arrotondati, con una morbida seduta che segue la forma e le linee degli schienali avvolgenti. Può essere rivestita interamente con tessuti e pelli della gamma Meridiani oppure avere le gambe frontali laccate o in essenza, per diventare un prodotto frizzante e di carattere, in grado di donare vivacità e, allo stesso tempo, ricercatezza alla zona dining.

The Cosette chair has a sleek silhouette and rounded volumes, with a soft seat that follows the shape and lines of the enveloping backrest. It can be upholstered entirely in fabrics and leathers of the Meridiani range, or have lacquered or wood front legs to become a sparkling product, able to give verve and, at the same time, sophistication to the dining area.

38, 39

COSETTE 2024

sedia - chair

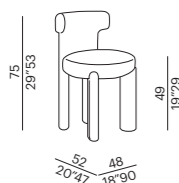

TECHNICAL DETAILS

IT

- sedia imbottita non sfoderabile in una selezione di tessuti di collezione
- struttura in legno curvato
- imbottitura in poliuretano e fibre poliestere
- gambe anteriori in massello di faggio tinto black - laccato opaco/lucido o rivestite in una selezione di tessuti di collezione (stesso tessuto della struttura)

EN

- padded chair with fixed cover in a selection of Meridiani fabrics
- curved wooden frame
- padding in polyurethane and polyester fiber
- front legs in solid beech black stained - matt or glossy lacquered - covered in a selection of Meridiani fabrics (same fabric as the frame)

DE

- gepolsterter Stuhl mit Festbezug aus einer Auswahl von Meridiani Stoffen
- Holzgestell
- Polsterung aus PU-Schäumen und Polyesterfaser
- Vorderfüße aus massiv Buchenholz black gebeizt - matt/Hochglanz lackiert oder mit Bezug aus einer Auswahl von Meridiani Stoffen (gleicher Stoff wie Gestell)

FR

- chaise rembourrée non déhoussable dans une sélection des tissus Meridiani
- structure en bois courbé
- embouillage en polyuréthane et fibre polyester
- pieds avant en hêtre massif teinté noir - laque mate ou brillante ou dans une sélection des tissus Meridiani (même tissu que la structure)

ES

- silla acolchada con funda fija en una selección de telas Meridiani
- estructura curvada de madera
- relleno en poliuretano y fibra poliéster
- patas delanteras de haya maciza teñida en negro - lacadas mate o brillo - tapizadas en una selección de telas Meridiani (misma tela que la estructura)



Claudine

Claudine, pensata sia come sedia da pranzo sia come poltroncina, è una seduta che può essere utilizzata come arredo complementare, e in abbinamento, alle sedie Cosette oppure come elemento indipendente. Claudine presenta uno schienale compatto e un aspetto monolitico, con un'unica gamba frontale dalle proporzioni generose, che può essere rivestita in tessuto, in essenza o laccata, per un risultato con un accento di carattere e un appeal visivo intenso e raffinato.

Conceived as both a dining chair and an armchair, Claudine is a seat that can be used as complementary furniture to Cosette chairs or as an independent product. Claudine has a compact back and a monolithic look, with a single, large front leg that may be upholstered in fabric, wood, or lacquer, giving the piece a personal touch and an intense, refined visual appeal.

40, 41

CLAUDINE 2024

sedia - chair

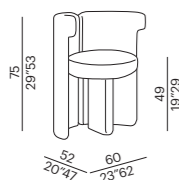

TECHNICAL DETAILS

IT

- sedia imbottita non sfoderabile in una selezione di tessuti di collezione
- imbottitura in poliuretano e fibre poliestere
- gamba centrale in massello di faggio tinto black - laccato opaco/lucido o rivestita in una selezione di tessuti di collezione (stesso tessuto della struttura)

EN

- padded chair with fixed cover in a selection of Meridiani fabrics
- padding in polyurethane and polyester fiber
- central leg in solid beech black stained - matt or glossy lacquered - covered in a selection of Meridiani fabrics (same fabric as the frame)

DE

- gepolsterter Stuhl mit Festbezug aus einer Auswahl von Meridiani Stoffen
- Polsterung aus PU-Schäumen und Polyesterfaser
- Mittelfuß aus massiv Buchenholz black gebeizt - matt/Hochglanz lackiert oder mit Bezug aus einer Auswahl von Meridiani Stoffen (gleicher Stoff wie Gestell)

FR

- chaise rembourrée non déhoussable dans une sélection des tissus Meridiani
- embourrage en polyuréthane et fibre polyester
- pied central en hêtre massif teinté noir - laque mate ou brillante ou dans une sélection des tissus Meridiani (même tissu que la structure)

ES

- silla acolchada con funda fija en una selección de telas Meridiani
- relleno en poliuretano y fibra poliéster
- pata central de haya maciza teñida en negro - lacada mate o brillo - tapizada en una selección de telas Meridiani (misma tela que la estructura)



Vetra

Un mobile concepito come una struttura architettonica, passando attraverso volumi semplici, compatti, solidi. La base monolitica forma il principale sostegno degli elementi contenitori, con ante o cassettoni. I singoli moduli, disponibili in tre larghezze, si prestano a un gioco di incastri nel basamento, e possono essere posizionati liberamente lungo i piani di appoggio, insieme anche a due diverse dimensioni di cuscini cilindrici, per creare composizioni versatili, in risposta a esigenze sia funzionali sia estetiche.

Vetra is a piece of furniture conceived as an architectural structure, that is built through simple, compact, and solid volumes. The monolithic base forms the main support of the storage elements, with doors or drawers. These separate units, which come in three widths, can be freely positioned along the base, combined also with two different sizes of cylindrical cushions, to form a variety of compositions that meet both practical and aesthetic needs.

42, 43

SKETCHES OF CONFIGURATIONS

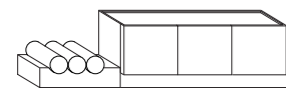

- 1 - basamento 80 - base 80
- 1 - basamento 160 - base 160
- 1 - contenitore centrale 150 - central storage unit 150
- 1 - cuscino 3 cilindri - cushion 3 bolsters

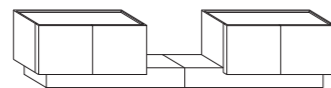

- 2 - basamento 140 - base 140
- 1 - contenitore terminale sx 100 - left end unit storage unit 100
- 1 - contenitore terminale dx 100 - right end unit storage unit 100

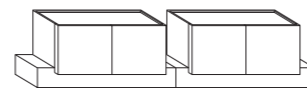

- 2 - basamento 140 - base 140
- 2 - contenitore centrale 100 - central storage unit 100

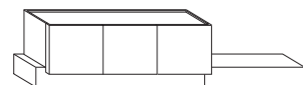

- 1 - basamento 160 - base 160
- 1 - basamento 100 - base 100
- 1 - contenitore centrale 150 - central storage unit 150



- 4 - basamento 100 - base 100
- 2 - contenitore centrale 100 - central storage unit 100



44, 45



VETRA contenitore . storage unit

TECHNICAL DETAILS

IT

- basamenti e contenitori modulari componibili
- struttura basamenti e contenitori non affiancabili in legno
- finiture basamenti: lacca opaca o lucida impiallacciatura rovere tinto light, black o tobacco rivestimento ottone bronzato, acciaio platinato, acciaio inox o acciaio orbitale rivestimento marmo MR1, MR2 o MR3
- finiture contenitori: lacca opaca o lucida impiallacciatura rovere tinto light, black o tobacco
- finiture piani: lacca opaca o lucida impiallacciatura rovere tinto light, black o tobacco vetro retroverniciato nei colori delle lacche (NO chalk, white) marmo MR1, MR2 o MR3
- cuscini sfoderabili - optional - in poliuretano e fibre poliestere

Suggerimento stilistico (vincolanti per display):
 - Se basamento e contenitore stessa finitura, piano possibile in tutte le finiture
 - Se basamento finitura diversa da contenitore, piano stessa finitura del contenitore

EN

- modular bases and storage units with wooden frame
- storage units cannot be placed side-by-side
- base finishes: matt or glossy lacquer light, black or tobacco stained oak veneer coated in bronzed brass, platinum steel, stainless steel, orbital steel coated in marble MR1, MR2 or MR3
- storage unit finishes: matt or glossy lacquer light, black or tobacco stained oak veneer
- top finishes: matt or glossy lacquer light, black or tobacco stained oak veneer back-painted glass in lacquer colours (except chalk, white) marble MR1, MR2 or MR3
- cushions with removable cover - optional - in polyurethane and polyester fiber

Stylistic suggestions (binding for display):
 - If base and storage unit have same finish, top can be in any finish
 - If base has different finish from storage unit, top should have same finish as storage unit

DE

- Sockel und Modulare Elemente aus Holz
- Elemente sind nebeneinander platzierbar
- Ausführungen für Sockel: Lack matt oder Hochglanz Eiche Furnier light, black oder tobacco Messing bronziert, Platinum Steel, Edelstahl oder Stahl mit Orbitalbearbeitung Verkleidung Marmorverkleidung MR1, MR2 oder MR3
- Ausführungen für Elemente: Lack matt oder Hochglanz Eiche Furnier light, black oder tobacco
- Ausführungen für Platte: Lack matt oder Hochglanz Eiche Furnier light, black oder tobacco Rücklackiertes Glas in alle Lackfarben (mit Ausnahme von chalk, white) Marmor MR1, MR2 oder MR3
- Rollenkissen - Extra - aus PU-Schäumen und Polyesterfaser

Stilistische Vorschläge (verbindlich für Platzierungen):
 - wenn Sockel und Elemente in selber Ausführung sind, kann die Platte in jeder Ausführung sein
 - wenn Sockel anderer Ausführung als Element ist, sollte die Platte in selber Ausführung wie Element sein rücklackiertes Glas möglich

FR

- socle et meubles de rangement modulables avec structure en bois
- les meubles ne peuvent pas être placés côte à côte
- finitions socles: laque mate ou brillante placage de chêne teinté light, black ou tobacco couverture en laiton bronzé, platinum steel, acier inoxydable, acier orbital couverture en marbre MR1, MR2 ou MR3
- finitions meubles de rangement: laque mate ou brillante placage de chêne teinté light, black ou tobacco
- finitions plateaux: laque mate ou brillante placage de chêne teinté light, black ou tobacco verre retro-laqué dans le couleurs de laque SAUF chalk, white marbre MR1, MR2 ou MR3
- coussins déhoussables - optional - en polyuréthane et fibre polyester

Suggestions stylistiques (obligatoires pour implantation):
 - Si base et meuble ont la même finition, le plateau peut être dans toutes finitions.
 - Si la base a une finition différente de celle du meuble, le plateau doit avoir la même finition que le meuble

ES

- bases y unidades modulares con estructura de madera
- las unidades no se pueden poner uno junto al otro
- acabados bases: laca mate o brillo enchapado de roble teñido light, black o tobacco revestido de latón bronceado, platinum steel, acero inoxidable, acero orbital revestido de mármol MR1, MR2 o MR3
- acabados unidades: laca mate o brillo enchapado de roble teñido light, black o tobacco
- acabados sobres: laca mate o brillo enchapado de roble teñido light, black o tobacco vidrio retrobarnizado en los colores de laca EXCEPTO chalk, white mármol MR1, MR2 o MR3
- cojines desenfundables - opcional - en poliuretano y fibra poliéster

Sugerencias estilísticas (vinculantes para exhibición):
 - Si base y unidad tienen el mismo acabado, el sobre puede ser en cualquier acabado
 - Si la base tiene un acabado diferente al de la unidad, el sobre debe tener el mismo acabado que la unidad

contenitore 50 - storage unit 50

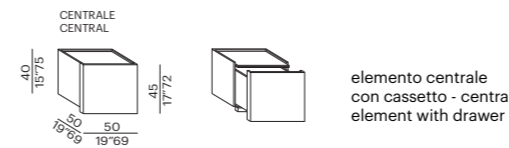

contenitore 100 - storage unit 100

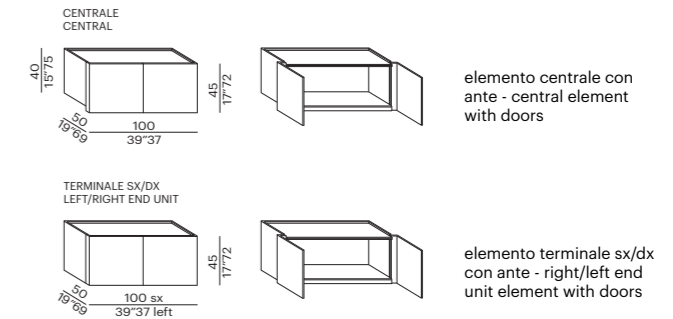

contenitore 100 - storage unit 100

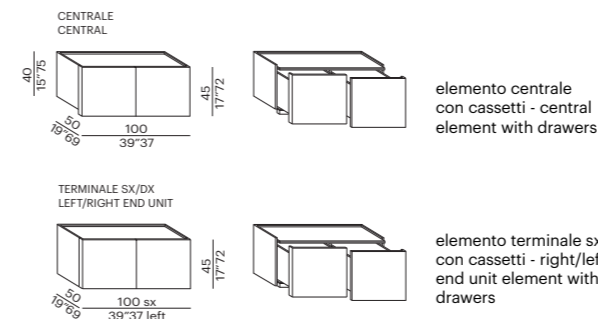

contenitore 150 - storage unit 150

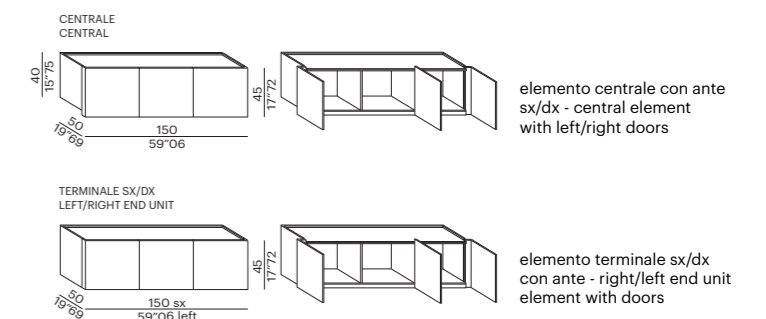

basamento 80 - base 80

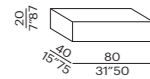

basamento 90 - base 90

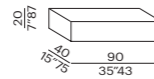

basamento 100 - base 100

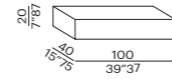

basamento 140 - base 140

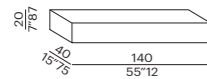

basamento 150 - base 150

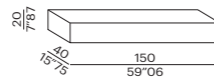

basamento 160 - base 160

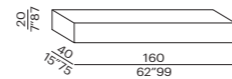

contenitore 150 - storage unit 150

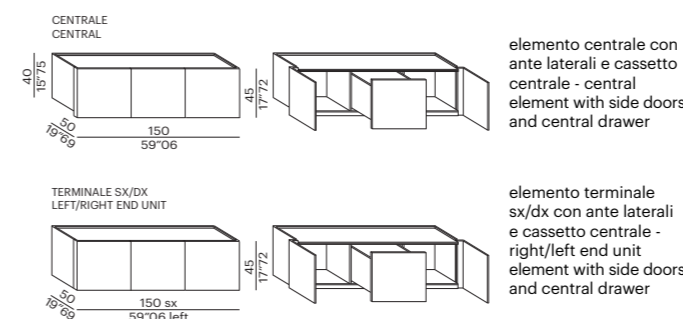

contenitore 150 - storage unit 150

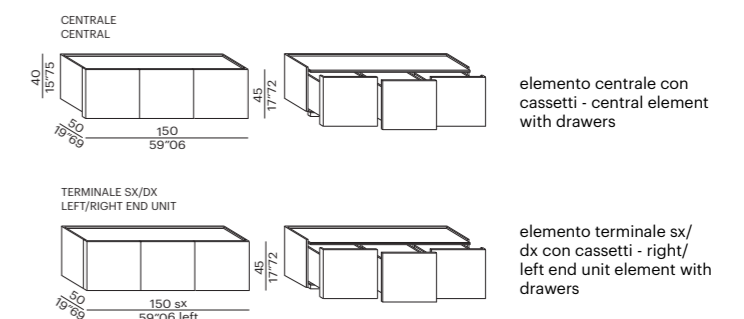

cuscino 3 cilindri - cushion 3

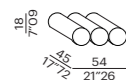

cuscino 4 cilindri - cushion 4

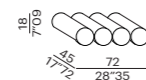

piano 50 - top 50

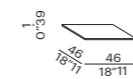

piano 100 - top 100

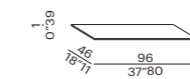

piano 150 - top 150

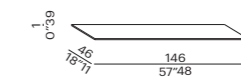

Romeo

Romeo è un mobile contenitore contraddistinto da una forma organica, pensato per ambienti living con arredi dalle forme arrotondate, a cui restituisce un effetto complessivo di sinuosità e visiva morbidezza. Le 16 nuance laccate di collezione, sia lucide sia opache, ne esaltano la forma sobria e pura, conferendogli, al contempo, anche una maggiore forza espressiva. Romeo è disponibile nella versione a tre o quattro ante.

Romeo is an organic-shaped storage unit designed for spaces with rounded-line furniture, giving an overall vibe of sinuosity and visual softness. The collection's 16 lacquer tones, both glossy and matt, highlight its simple and pure form while also adding expressive energy. Romeo is available in three- and four-door versions.

48, 49

ROMEIO 2024

contenitore 150 - storage unit 150

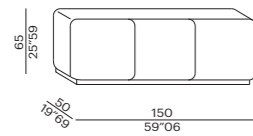

contenitore 200 - storage unit 200

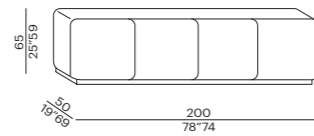

TECHNICAL DETAILS

IT

- contenitori con ante e cassettoni:
- 150: due ante laterali e un cassettoni centrale
- 200: due ante laterali e due cassettoni centrali
- struttura in legno
- finiture:
- lacca opaca o lucida (basamento e contenitore stessa finitura e colore)

finiture

- vedi campionario

EN

- storage units with doors and drawers:
- 150: 2 side doors and 1 central drawer
- 200: 2 side door and 2 central drawers
- wooden frame
- finishes:
- matt or glossy lacquer (base and storage in same finish and colour)

finishes

- see sample box

DE

- Anrichten mit Türen und Schubladen
- 150: zwei Türen an den Seiten und eine Schublade in der Mitte
- 200: zwei Türen an den Seiten und zwei Schubladen in der Mitte
- Holzgestell
- Ausführungen:
- Lack matt oder Hochglanz (Gestell und Elemente in der gleichen Ausführung und Farbe)

Ausführungen

- siehe Musterbox

FR

- meubles de rangement avec portes et tiroirs:
- 150: deux portes latérales et un tiroir central
- 200: deux portes latérales et deux tiroirs centraux
- structure en bois
- finitions:
- laque mate ou brillante (base et meuble dans le même finition et couleur)

finitions

- voir boîte d'échantillons

ES

- aparador con puertas y cajones:
- 150: 2 puertas laterales y 1 cajón central
- 200: 2 puertas laterales y 2 cajones centrales
- estructura de madera
- acabados:
- laca mate o brillo (base y unidad en mismo acabado y color)

acabados

- véase el muestrario





50, 51

ROMEO contenitore . storage unit

Wallis

Un gioco di linee concave e convesse, lineari o curve. Wallis è il mobile contenitore Meridiani pensato sia per la zona giorno, con ante, sia per la zona notte come vera e propria cassetiera. Il progetto prevede quattro unità, in quattro forme, che possono vivere singolarmente oppure essere accostate tra loro, dando vita a composizioni e interpretazioni differenti. Le finiture disponibili sono laccature lucide e opache; il top, inoltre, è realizzabile in marmo, quartzite, travertino, vetro retro-verniciato o cuoio. Questo singolare eclettismo rende Wallis il perfetto alleato per un arredamento unico e personale, da sempre cifra stilistica di Meridiani.

An interplay of concave and convex, linear or curved lines. Wallis is a Meridiani storage unit designed for both the living room - with doors -, and the bedroom, as a pure chest of drawers. The design consists of four parts in four forms that can be used alone or in combination, resulting in a variety of compositions and interpretations. The various finishes include glossy and matt lacquers, and the top can be made of marble, quartzite, travertine, back-painted glass, or saddle leather. This remarkable eclecticism makes Wallis an ideal partner for unique and personal furnishings, which has always been Meridiani's stylistic hallmark.

52, 53



TECHNICAL DETAILS

<p>IT</p> <ul style="list-style-type: none"> • contenitori o cassettiere: UNO: a tre ante o tre cassetti e un'anta DUE: a tre ante o sei cassetti TRE: a due ante o tre cassetti QUATTRO: a tre ante o tre cassetti e un'anta • struttura in legno • finiture struttura: lacca opaca o lucida • finiture piano: lacca opaca o lucida vetro retroverniciato nei colori delle lacche (NO chalk, white) marmo MR1, MR2 o MR3 cuoio - optional <p>finiture • vedi campionario</p>	<p>EN</p> <ul style="list-style-type: none"> • storage units or chest of drawers: UNO: 3 doors or 3 drawers and 1 door DUE: 3 doors or 6 drawers TRE: 2 doors or 3 drawers QUATTRO: 3 doors or 3 drawers and 1 door • wooden frame • frame finishes: matt or glossy lacquer • top finish: matt or glossy lacquer back-painted glass in lacquer colours (except chalk, white) marble MR1, MR2 o MR3 saddle leather - optional <p>finishes • see sample box</p>	<p>DE</p> <ul style="list-style-type: none"> • Anrichten oder Schubladenkasten: UNO: drei Türen oder drei Schubladen und eine Tür DUE: drei Türen oder sechs Schubladen TRE: zwei Türen oder drei Schubladen QUATTRO: drei Türen oder drei Schubladen und eine Tür • Holzgestell • Ausführung für Gestell: Lack matt oder Hochglanz • Ausführung für Platte: Lack matt oder Hochglanz Rücklackiertes Glas in alle Lackfarben (mit Ausnahme von chalk, white) Marmor MR1, MR2 oder MR3 Kernleder - Extra <p>Ausführungen • siehe Musterbox</p>	<p>FR</p> <ul style="list-style-type: none"> • meubles de rangement ou commodes: UNO: avec trois portes ou trois tiroirs et une porte DUE: avec trois portes ou six tiroirs TRE: avec deux portes ou trois tiroirs QUATTRO: avec trois portes ou trois tiroirs et une porte • structure en bois • finition structure: laque mate ou brillante • finitions plateaux: laque mate ou brillante verre retro-laqué dans les couleurs de laque SAUF chalk, white marbre MR1, MR2 ou MR3 cuir sellier - optional <p>finitions • voir boîte d'échantillons</p>	<p>ES</p> <ul style="list-style-type: none"> • aparadores o cajoneras: UNO: con 3 puertas o 3 cajones y 1 puerta DUE: con 3 puertas o 6 cajones TRE: con 2 puertas o 3 cajones QUATTRO: con 3 puertas o 3 cajones y 1 puerta • estructura de madera • acabados estructura: laca mate o brillo • acabados sobre: laca mate o brillo vidrio retrobarnizado en los colores de laca EXCEPTO chalk, white mármol MR1, MR2 o MR3 cuero - opcional <p>acabados • véase el muestrario</p>
---	---	---	--	---



54, 55

contenitore UNO - storage unit UNO

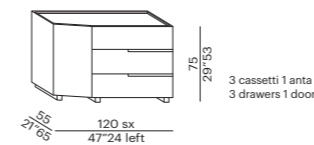
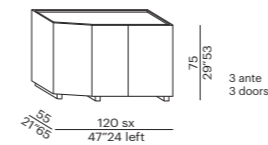

contenitore DUE - storage unit DUE

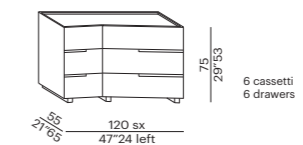
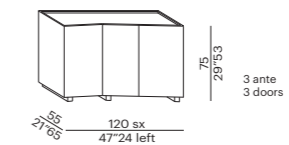

contenitore TRE - storage unit TRE

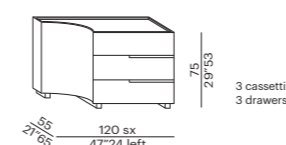
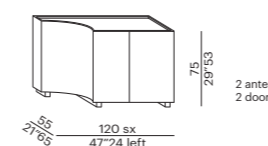

contenitore QUATTRO - storage unit QUATTRO

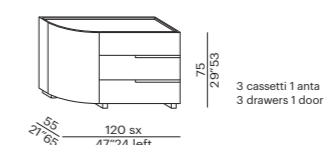
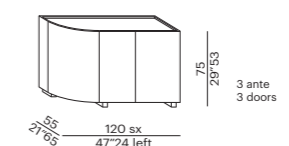



56, 57

Johnny

Forme essenziali e funzionali: Johnny è un nuovo complemento Meridiani per lo spazio notte. È un comodino cilindrico, disponibile in versione con cassetti o con anta, definito da un disegno frontale concavo e da un top ribassato, che è possibile realizzare in lacca lucida o opaca, come la struttura, e anche in marmo. A completamento della collezione, l'opzione di un piano in cuoio posizionabile liberamente sui top.

Essential and functional shapes: Johnny is the new Meridiani complement for the bedroom. Johnny is a cylindrical night table available with drawers or with a door, defined by a concave front design and a lowered top, which can be made in glossy or matt lacquer - like the frame - as well as in marble. To complete the collection, a saddle leather cover can be placed over the existing top.

58, 59

JOHNNY 2024

comodino - night table

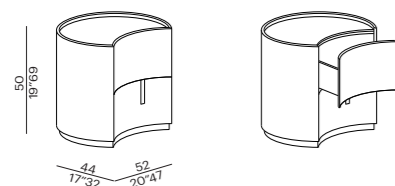

TECHNICAL DETAILS

IT

- comodino con due cassetti
- struttura in legno
- finiture struttura: lacca opaca o lucida
- finiture piano: lacca opaca o lucida
- vetro retroverniciato nei colori delle lacche (NO chalk, white)
- marmo MR1, MR2 o MR3
- cuoio - optional

finiture

- vedi campionario

EN

- night table with 2 drawers
- wooden frame
- frame finishes: matt or glossy lacquer
- top finish: matt or glossy lacquer
- back-painted glass in lacquer colours (except chalk, white)
- marble MR1, MR2 o MR3
- saddle leather - optional

finishes

- see sample box

DE

- Nachttisch mit zwei Schubladen
- Holzgestell
- Ausführung für Gestell: Lack matt oder Hochglanz
- Ausführung für Platte: Lack matt oder Hochglanz
- Rücklackiertes Glas in alle Lackfarben (mit Ausnahme von chalk, white)
- Marmor MR1, MR2 oder MR3
- Kernleder - Extra

Ausführungen

- siehe Musterbox

FR

- chevet avec deux tiroirs
- structure en bois
- finition structure: laque mate ou brillante
- finitions plateau: laque mate ou brillante
- verre retro-laqué dans les couleurs de laque SAUF chalk, white
- marbre MR1, MR2 ou MR3
- cuir sellier - optional

finitions

- voir boîte d'échantillons

ES

- mesita de noche con 2 cajones
- estructura de madera
- acabados estructura: lacca mate o brillo
- acabados sobre: lacca mate o brillo
- vidrio retrobarnizado en los colores de lacca EXCEPTO chalk, white
- mármol MR1, MR2 o MR3
- cuero - opcional

acabados

- véase el muestrario



Ronny

Ronny è la soluzione per lo spazio notte di chi ama la pratica semplicità. Condividendo lo stesso disegno frontale alla base del comodino Johnny, Ronny ha una struttura più leggera e sottile, composta da un unico e funzionale cassettino. A completamento della collezione, l'opzione di un piano in cuoio posizionabile liberamente sui top.

Ronny is the sleeping space solution for those who love practical simplicity. It shares the same frontal design as the Johnny night table, but with a lighter, slimmer frame consisting of a single, functional drawer. To complete the collection, a saddle leather cover can be placed over the existing top.

60, 61

RONNY 2024

comodino - night table

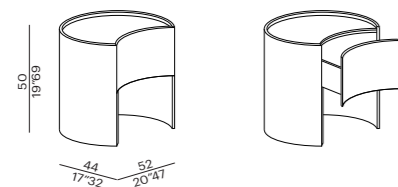

TECHNICAL DETAILS

IT

- comodino con un cassetto
- struttura in legno
- finiture struttura: lacca opaca o lucida
- finiture piano: lacca opaca o lucida
- vetro retroverniciato nei colori delle lacche (NO chalk, white)
- marmo MR1, MR2 o MR3
- cuoio - optional

finiture
• vedi campionario

EN

- night table with 1 drawer
- wooden frame
- frame finishes: matt or glossy lacquer
- top finish: matt or glossy lacquer
- back-painted glass in lacquer colours (except chalk, white)
- marble MR1, MR2 o MR3
- saddle leather - optional

finishes
• see sample box

DE

- Nachttisch mit einer Schublade
- Holzgestell
- Ausführung für Gestell: Lack matt oder Hochglanz
- Ausführung für Platte: Lack matt oder Hochglanz
- Rücklackiertes Glas in alle Lackfarben (mit Ausnahme von chalk, white)
- Marmor MR1, MR2 oder MR3
- Kernleder - Extra

Ausführungen
• siehe Musterbox

FR

- chevet avec un tiroir
- structure en bois
- finition structure: laque mate ou brillante
- finitions plateau: laque mate ou brillante
- verre retro-laqué dans les couleurs de laque SAUF chalk, white
- marbre MR1, MR2 ou MR3
- cuir sellier - optional

finitions
• voir boîte d'échantillons

ES

- mesita de noche con 1 cajón
- estructura de madera
- acabados estructura: lacca mate o brillo
- acabados sobre: lacca mate o brillo
- vidrio retrobarnizado en los colores de lacca EXCEPTO chalk, white
- mármol MR1, MR2 o MR3
- cuero - opcional

acabados
• véase el muestrario



Tuyo

A conferma dell'identità camaleontica e delle numerose possibilità di personalizzazione del letto Tuyo, questa collezione di letti si amplia con una nuova testiera e un'inedita trapuntatura. La nuova testiera Curve diventa un elemento avvolgente, curvandosi alle estremità laterali, come ad abbracciare la base del letto per delineare un angolo notte intimo e confortevole. La nuova trapuntatura Ball è in grado di esaltare maggiormente la tridimensionalità delle testiere attraverso soffici bolle definite con cura sartoriale.

The Tuyo bed series adds a new headboard and quilting, underscoring and confirming the Tuyo bed's chameleon-like nature and countless customization options. The new Curve headboard is an enveloping feature, flexing at the side ends as if to embrace the bed, creating an intimate and cozy sleeping nook. The new Ball quilting enhances the three-dimensionality of the headboards with soft bubbles defined and sewn with sartorial care.

TECHNICAL DETAILS

IT	EN	DE	FR	ES
<p>TESTIERA LOW CURVE</p> <ul style="list-style-type: none"> • testiere letto a muro h.120 imbottite • e sfoderabili complete di supporti per fissaggio a muro • basamento in legno tinto black - in tre parti con spazio passacavi • composto da un pannello dritto centrale e due pannelli curvi laterali • rivestimento intero 	<p>LOW CURVE HEADBOARD</p> <ul style="list-style-type: none"> • padded headboards for wall-hanging h.120 with removable cover, fittings for wall-hanging included • wooden base, black stained - divided into 3 parts for cable passages • composed of one central straight panel and 2 side curved panels • single frame cover 	<p>LOW CURVE HEADBOARD</p> <ul style="list-style-type: none"> • gepolsterte und abziehbare Kopfteile H.120 zur Wandmontage mit Befestigungsbeschläge für Wandmontage • Holzsockel schwarz gebeizt - bestehend aus drei Teilen, mit Kabeldurchgang • bestehend aus einem geraden Mittelpaneel und zwei gebogenen Seitenpaneele • durchgehende Housse 	<p>LOW CURVE HEADBOARD</p> <ul style="list-style-type: none"> • ète de lit a mur h.120 rembourrées et déhoussables, fournis avec supports pour fixage au mur • base en bois teinté black - divisées en trois pièces avec passe-câble • composé d'un panneau central droit et deux panneaux latéraux courbés • housse entière 	<p>LOW CURVE HEADBOARD</p> <ul style="list-style-type: none"> • cabezales H120 acolchados y desenfundables con soportes para colgar a pared • base de madera teñido black - en 3 partes con espacio para cables • compuesto de un panel central recto y dos paneles laterales curvos • funda entera
<p>rivestimento in tessuto lavabile solo a secco</p>	<p>fabric cover: dry cleaning only</p>	<p>Stoffbezug nur Trockenreinigung</p>	<p>housse en tissu: nettoyage uniquement à sec</p>	<p>funda en tela sólo limpiar en seco</p>
<p>È disponibile la nuova trapuntatura Ball</p>	<p>The new Ball quilting is now available</p>	<p>The new Ball quilting is now available</p>	<p>The new Ball quilting is now available</p>	<p>The new Ball quilting is now available</p>

testiera - headboard LOW CURVE

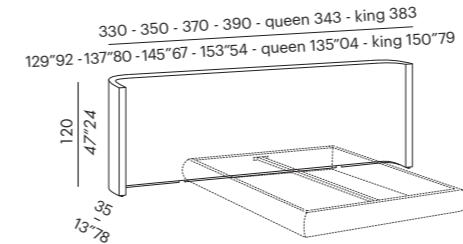

esempio di composizione - sketch of configuration

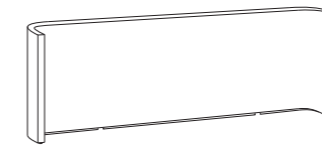

finitura - finish: plain

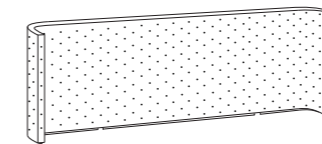

finitura - finish: quilt

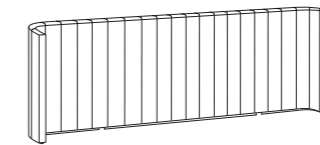

finitura - finish: stripe

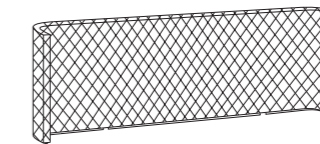

finitura - finish: diamond

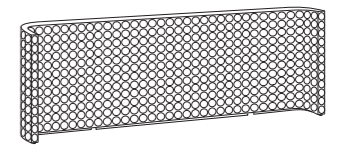

finitura - finish: ball

64, 65



Vincent Open Air

Vincent è un prodotto outdoor che si distingue per la sua grande modularità e le proporzioni generose. Il modulo base di Vincent costituisce l'elemento chiave del progetto: una "tessera" che può essere liberamente accostata per composizioni ampie o contenute, in linea o angolari, grazie anche al pouf e all'elemento trapezoidale, che offre maggiori possibilità di personalizzazione e configurazione. A completare la collezione, la chaise longue disponibile con seduta tonda o quadrata.

Vincent is an outdoor product characterized by significant versatility and generously proportioned seating. Vincent's basic module serves as the project's focal point: it is a "tile" that may be freely juxtaposed for wide or compact, in-line or corner compositions. The pouf and trapezoidal element further enhance customization and configuration options. The chaise longue, with its square or round seats, completes the collection.

TECHNICAL DETAILS

IT

- elementi componibili sfoderabili
- schienale e piastre in acciaio AISI 316
- finiture: verniciato a polvere poliestere white - brick - putty - micaceo
- inserti schienale in massello di iroko
- finitura: iroko con vernice protettiva
- cuscini in poliuretano a densità differenziate con fodera in tessuto tecnico idrorepellente
- finitura con piping white - brick - putty - micaceo lavabile solo a secco
- piedini regolabili
- cuscini - optional - in microball 100% poliestere con fodera in tessuto tecnico idrorepellente

water proof cover

- cover protettive impermeabili realizzate con tessuto tecnico, su misura per ogni prodotto

EN

- modular units with removable covers
- backrest and plates in steel AISI 316
- finishes: polyester powder coated in colors white - brick - putty - micaceo
- backrest insert in solid iroko wood
- finish: iroko with protective varnish
- cushions in varied density polyurethane with water-repellent technical fabric
- cover with piping white - brick - putty - micaceo - dry cleaning only
- adjustable feet
- cushions - optional - in 100% polyester microball with water-repellent technical fabric

water proof cover

- protective waterproof cover made in technical fabric, customized for each product

DE

- abziehbare Anbauelemente
- Rücklehne und Platten aus Stahl AISI 316
- Ausführungen: Gestell aus mit Polyesterstaub lackiertem Metall. Farben: White - Brick - Putty - Micaceo
- Rücklehneinsatz aus massiv Irokoholz
- Ausführung: Irokoholz mit Schutzlack
- Kissen aus PU-Schäumen unterschiedlicher Dichte mit Futter aus wasserdichten technischen Textilien
- Kederbezug white - brick - putty - micaceo - nur Trockenreinigung
- verstellbare FüÙe
- Kissen - optional - aus 100% Polyester Microball mit Futter aus wasserdichten technischen Textilien

water proof cover

- Schützende wasserdichte Bezüge aus technischen Textilien nach Produktmaß

FR

- Éléments déhoussables et modulables
- Dossier et plaques en acier AISI 316
- finitions: verni en poudre polyester couleur white - brick - putty - micaceo
- insert dossier en iroko massif
- finition: iroko massif avec vernis protecteur
- coussins en polyuréthane à densités différenciées avec sous housses en tissu technique hydrofuge
- housse avec passepoil white - brick - putty - micaceo - nettoyage uniquement à sec
- pieds réglables
- coussins - optionnel - in microball 100% polyester avec sous housses en tissu technique hydrofuge

water proof cover

- housse de protection imperméable en tissu technique hydrofuge, sur mesure pour chaque produit

ES

- elementos modulares desenfundables
- respaldo y placas en acero AISI 316
- acabados: barnizado en polvo poliéster color white - brick - putty - micaceo
- inserto respaldo de iroko macizo
- acabado: iroko con barniz protector
- cojines en poliuretano con densidad diferenciada, con funda farro impermeable en tejido técnico
- funda con perfil white - brick - putty - micaceo - solo lavar en seco
- patas regulables
- cojines - opcional - de microball 100% poliéster, con funda farro impermeable en tejido técnico

water proof cover

- fundas de protección impermeable en tejido técnico, a medida para cada producto

elemento - unit 95

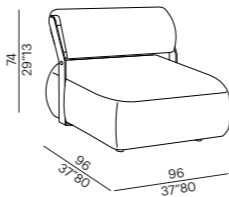

elemento - unit 180

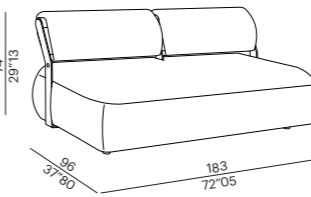

elemento - unit TRAPEZIUM

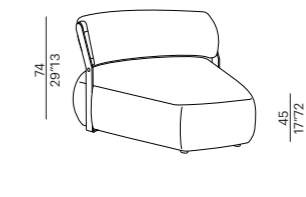

chaise longue SQUARE

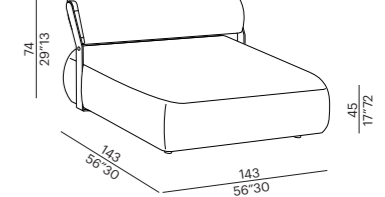

SKETCHES OF CONFIGURATIONS

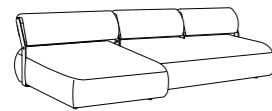

1 - chaise longue SQUARE
1 - elemento - unit 180

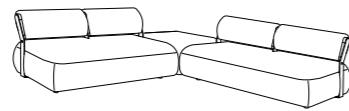

2 - elemento - unit 180
1 - pouf 95

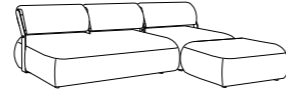

1 - elemento - unit 180
1 - elemento - unit 95
1 - pouf 95

chaise longue ROUND

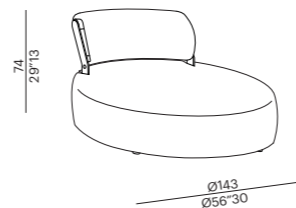

pouf 95

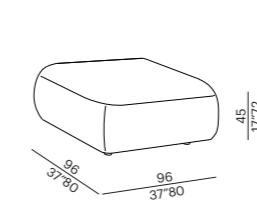

cuscino - cushion 55



cuscino - cushion 75



cuscino - cushion 55R

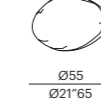

cuscino - cushion 75R

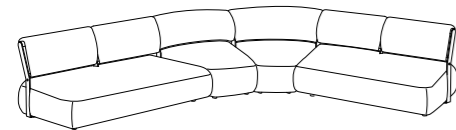
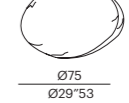

2 - elemento - unit 180
2 - elemento - unit TRAPEZIUM

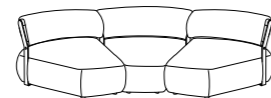

3 - elemento - unit TRAPEZIUM

Bongo Open Air

Differenti declinazioni di un solido geometrico conferiscono il look a questa collezione di tavoli bassi, disponibili in varie misure e in colori laccati. La finitura opaca rende Bongo Open Air utilizzabile anche in ambienti outdoor, così come anche l'opzione del top in pietra lavica vetrificata - estratta dalle pendici dell'Etna e trattata con diversi cicli di cottura ad alte temperature - conferisce resistenza alla superficie, assicurando un risultato a regola d'arte, sostenibile e dalla sincera anima Made in Italy.

Different variations of a geometric solid determine the look to this collection of low tables, available in various sizes and lacquered colors. The matt finish makes Bongo Open Air also suitable in outdoor environments, as well as the option of a glazed lava stone top - extracted from the slopes of Etna (Sicily, Italy) and treated with several cycles at high temperatures - gives strength to the surface, ensuring a flawless, sustainable result with a true Made in Italy soul.

BONGO OPEN AIR 2013

tavolo basso - low table TB-1

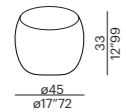

tavolo basso - low table TB-2

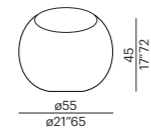

tavolo basso - low table TB-4

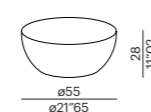

tavolo basso - low table TB-4

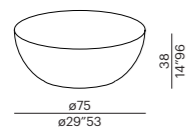

tavolo basso - low table TB-5

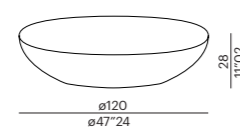

TECHNICAL DETAILS

IT

- tavoli bassi
- elementi in poliuretano rigido strutturale
- finiture: lacca opaca - vedi campionario
- finiture piani: pietra lavica vetrificata (TB-1 / TB-2 / TB-5)

water proof cover
• cover protettive impermeabili realizzate con tessuto tecnico, su misura per ogni prodotto

EN

- low tables
- low tables in rigid bearing polyurethane
- finishes: matt lacquer - see sample box
- top finishes: vitrified lava stone (TB-1 / TB-2 / TB-5)

water proof cover
• protective waterproof cover made in technical fabric, customized for each product

DE

- Beistelltische
- Elemente aus hartem unverformbarem Polyurethan
- Ausführungen: Lack matt - siehe Musterbox
- Ausführungen für die Platte: verglaster Lavastein (TB-1 / TB-2 / TB-5)

water proof cover
• Schützende wasserdichte Bezüge aus technischen Textilien nach Produktmaß

FR

- tables basses
- structure en polyuréthane rigide
- finitions: laque mate - voir boîte d'échantillons
- finitions plateaux: pierre de lave vitrifiée

water proof cover
• housse de protection imperméable en tissu technique hydrofuge, sur mesure pour chaque produit

ES

- mesitas
- elementos en poliuretano rígido estructural
- acabados: lacca mate - véase el muestrario
- acabados sobres: piedra de lava vitrificada (TB-1 / TB-2 / TB-5)

water proof cover
• fundas de protección impermeable en tejido técnico, a medida para cada producto

Fabien Open Air

Il tavolino Fabien Open Air unisce la resistenza di una struttura in metallo zincato con la ricercatezza dei piani sostenibili in pietra lavica vetrificata. Il top, in rosso, giallo, grigio o verde asparago, rivela una perfetta collaborazione tra tecnologia e natura: la pietra lavica naturale, estratta dalle pendici dell'Etna, viene trattata ad alte temperature e impreziosita con vetri frantumati di monitor di tv e pc in disuso. Questo know-how unico nel suo genere garantisce eccellenti prestazioni in esterno e un'immagine estetica pregiata.

The Fabien Open Air low table combines the strength of a galvanized metal frame with the sophistication of the glazed lava stone surface. The top, in red, yellow, gray, or asparagus green, reveals a perfect collaboration between technology and nature: natural lava stone, quarried from the slopes of Mount Etna (Sicily, Italy), is treated at high temperatures and embellished with crushed glass from disused TV and PC monitors. This one-of-a-kind expertise ensures great outdoor performance and an eye-catching look.

FABIEN OPEN AIR 2024

tavolo basso - low table 50R

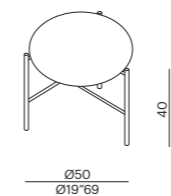

tavolo basso - low table 70R

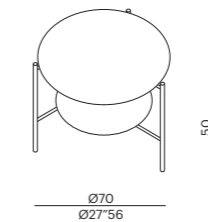

TECHNICAL DETAILS

IT

- tavoli bassi
- struttura tubolare in metallo zincato
- finiture struttura: verniciato a polvere poliestere white - terracotta - putty - micaceo
- piani con sagomatura perimetrale
- finiture piani: pietra lavica vetrificata

finiture
• vedi campionario

water proof cover
• cover protettive impermeabili realizzate con tessuto tecnico, su misura per ogni prodotto

EN

- low tables
- tube metal zincato frame
- frame finishes: with polyester powder color white - terracotta - putty - micaceo
- shaped tops
- finishes for tops: vitrified lava stone

finishes
• see sample box

water proof cover
• protective waterproof cover made in technical fabric, customized for each product

DE

- Beistelltische
- Rohrgestell aus Metall zincato
- Ausführungen für das Gestell: vernishiert in der Farben white - terracotta - putty - micaceo
- geformte Platte
- Platte Ausführungen: verglaster Lavastein

Ausführungen
• siehe Musterbox

water proof cover
• Schützende wasserdichte Bezüge aus technischen Textilien nach Produktmaß

FR

- tables basses
- structure tubulaire en métal zincato
- finitions structure: vernis en poudre polyester couleur white - terracotta - putty - micaceo
- plateaux ronds sur le périmètre
- finitions des plateaux: pierre de lave vitrifiée

finitions
• voir boîte d'échantillons

water proof cover
• housse de protection imperméable en tissu technique hydrofuge, sur mesure pour chaque produit

ES

- mesitas
- estructura tubular en metal zincato
- acabados estructura: barnizado en polvo poliéster color white - terracotta - putty - micaceo
- sobres perfilados
- acabados sobres: piedra de lava vitrificada

acabados
• véase el muestrario

water proof cover
• fundas de protección impermeable en tejido técnico, a medida para cada producto

FINITURE . FINISHING

lacca opaca e lucida . matt and glossy lacquer



rovere . oak wood

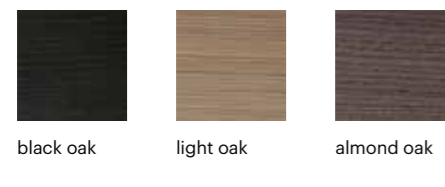

faggio . beech-wood

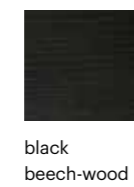

metallo . metal

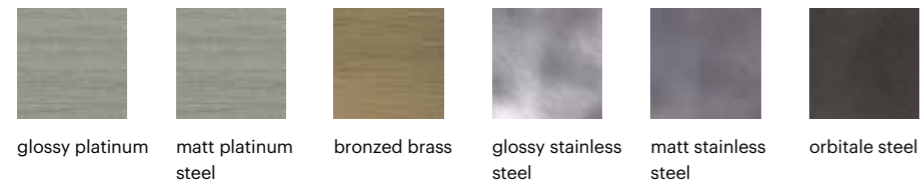

vetro retroverniciato . painted glass



cuoio . saddle leather



marmo . marble

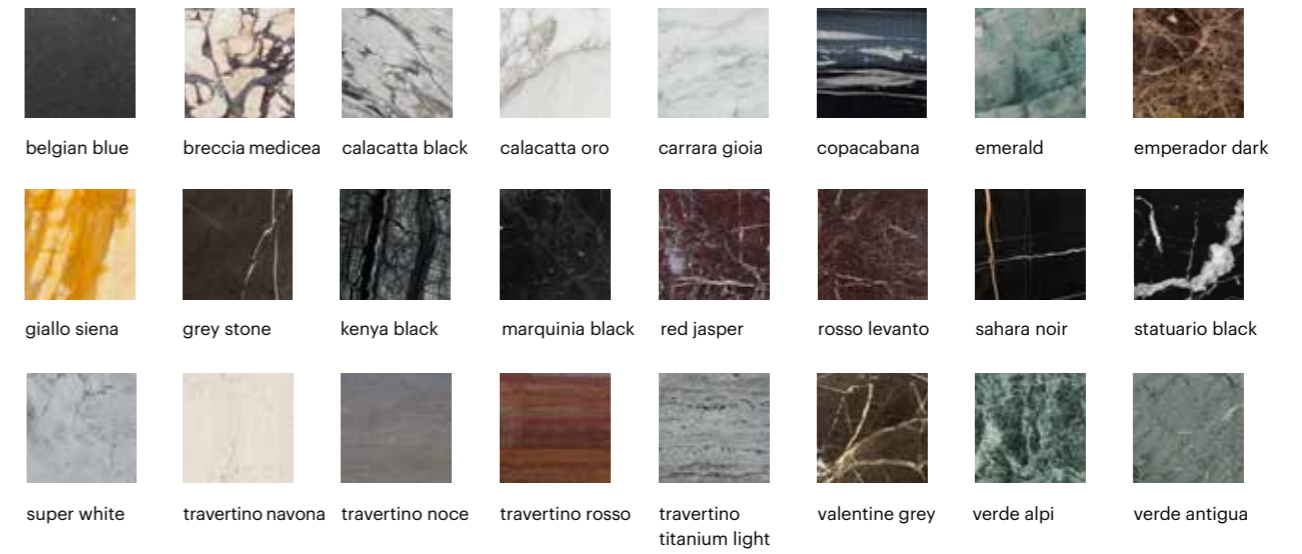

FINITURE OPEN AIR . OPEN AIR FINISHING

metallo zincato verniciato . zinc-coated metal

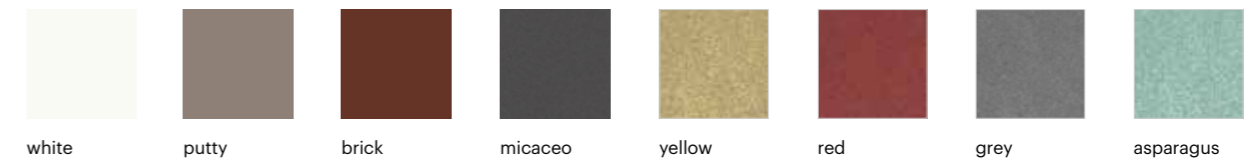

pietra lavica vetrificata . vitrified lava stone



lacca opaca . matt lacquer



ART DIRECTION

Andrea Parisio

GRAPHIC AND CONCEPT IMAGE

VZNstudio

(Nicola Iannibello, Sonia Mion)

PHOTO

Davide Lovatti

STYLING

Laura Tocchet (PP. 3, 32)

PRINTED IN ITALY BY

Euroteam, April 2024

MERIDIANI SRL

20826 MISINTO ITALY

VIA BIRAGO, 16

TEL +39 02 96 69 161

INFO@MERIDIANI.IT

MERIDIANI.IT



#Meridianlivinginteriors

© MERIDIANI SRL

COPYRIGHT 1998

APRIL 2024

Le immagini riprodotte su questo catalogo sono un suggerimento di configurazioni, per le caratteristiche tecniche e dimensioni consultare l'area riservata del nostro sito meridiani.it. Meridiani srl si riserva la facoltà di modificare, in qualunque momento e senza preavviso, le caratteristiche tecniche ed estetiche dei modelli illustrati nel presente catalogo. I prodotti Meridiani sono 100% made in italy.

The products displayed in this catalogue are to be considered as sample configurations. For any technical specifications and/or dimensions, please visit the reserved area of our website meridiani.it. Meridiani srl reserves the right to modify, at any time and without prior notice, the technical and aesthetic characteristics of the models shown in this catalogue. Meridiani products are 100% made in italy.

