

SERRALUNGA

MADE IN ITALY

Since 1825

smart collection



SERRALUNGA
MADE IN ITALY Since 1825

SMART
COLLECTION

Sommario / Contents

Welcome

Pg. 4	Manifesto
Pg. 6	Ripensando 1825 / Re-thinking 1825
Pg. 8	Due secoli, cinque generazioni Two centuries, five generations
Pg. 9	Tutti i numeri di Serralunga All the figures of Serralunga

Furniture

Pg. 10	Alice Design: Patrizia Pozzi
Pg. 14	Bay Design: Raffaella Mangiarotti
Pg. 20	Dado Design: Fabio Bortolani e Ermanno Righi
Pg. 22	Giulietta Design: Paolo Rizzato
Pg. 26	Lounge Cube — <i>Arredare iconico</i> Design: Serralunga
Pg. 30	Luba Design: Ionna Vautrin
Pg. 34	Milo Design: Aquilialberg

Pg. 38	Oasis Design: Sebastian Bergne
Pg. 40	Palenquera Design: Lina Obregon
Pg. 44	Porcino Design: Aldo Cibic
Pg. 48	Playa Design: Serralunga
Pg. 50	Rainbow Design: Serralunga
Pg. 54	Romeo Design: Paolo Rizzato
Pg. 58	Sirchester Design: Bazzicalupo / Mangiarotti

Lights

Pg. 62	Atmosfera — <i>Metti una sera, la luna in giardino</i> Design: Serralunga
Pg. 68	Flame Design: Sebastian Bergne
Pg. 72	Pic Nic Design: Joan Gaspar

Pots

Pg. 76	Bordato Liscio — <i>Effetto cascina</i> Design: Serralunga
Pg. 84	Camelia — <i>Affinità elettive</i> Design: Serralunga
Pg. 86	Cubotti — <i>Volumetrie essenziali</i> Design: Nat Wave
Pg. 88	Cubotti Deep Design: Nat Wave
Pg. 92	Cup — <i>Nuovi paradigmi</i> Design: Naoto Fukasawa
Pg. 98	Fence — <i>Sognando la Francia</i> Design: Raffaella Mangiarotti
Pg. 104	Kabin — <i>L'archetipo & il colore</i> Design: Luisa Bocchietto
Pg. 110	Liscio Siena — <i>Profumo d'Italia</i> Design: Serralunga
Pg. 114	Marcantonio — <i>Movimento verticale</i> Design: Nat Wave
Pg. 116	Marcantonio au mur Design: Nat Wave
Pg. 120	Memory Pot — <i>Imperfetto naturale</i> Design: Marta Daza Fernandez
Pg. 124	Neoclassic — <i>Il classico contemporaneo</i> Design: Serralunga
Pg. 128	Newpot — <i>Teorie cromatiche</i> Design: Paolo Rizzato
Pg. 134	Pot Au Mur Design: Ecal / Nicolas Le Moigne

Pg. 138	Torre — <i>Pezzi d'Arredo</i> Design: Serralunga
Pg. 142	Tubini — <i>Basico contemporaneo</i> Design: Nat Wave
Pg. 146	Vaso Rettangolare O/E — <i>Confine naturale</i> Design: Serralunga
Pg. 150	Decorati — <i>New bucolics</i> Design: Serralunga
Pg. 162	Graniglia — <i>Sfumature tattili</i> Design: Serralunga
Pg. 164	Millerighe — <i>L'utile e il dilettevole</i> Design: Serralunga

Technical informations

Pg. 169	Colori / Colors
Pg. 171	Finiture superfici / Surface finishing
Pg. 172	Istruzioni per invasatura / Potting instructions
Pg. 173	Drenaggio e fissaggio a terra / Water drainage and ground fixing
Pg. 174	Materiale / Material
Pg. 175	Impianti luce / Lighting systems

Lavorando sul colore, sulle forme iconiche, sulle finiture naturali, il nuovo catalogo 1825 compie un nuovo sforzo nella reinterpretazione del vaso di plastica. La volontà di Serralunga 1825 è quella di partecipare alla creazione di luoghi confortevoli, ambienti in cui rifugiarsi, evadere dalla realtà e viaggiare con il pensiero: spazi in cui, finalmente, tornare a respirare. Riportare la Natura in casa, darle spazio in giardino, costruire una casa verde: una membrana osmotica tra dentro e fuori, città e campagna, luce e vita. Per recuperare il contatto con l'autenticità e con la sfera intima e personale del quotidiano.

Playing with colours, iconic shapes and natural finishing touches, the new 1825 catalogue makes an important effort to reinterpret the plastic pot. The aim of Serralunga 1825 is to create comfortable environments where people can relax, daydream and finally breathe again.

Natural areas in your home or in the garden can be created or enhanced: a greenhouse that works as a doorway between indoor and outdoor, city and country, light and life, while authentic everyday intimacy is encouraged.

Serralunga 1825 è un'azienda di famiglia, radicata nella storia e nella tradizione. Che si trovino sul ciglio di una strada, su una terrazza o nel parco di una villa storica, i prodotti 1825 si sono integrati nelle nostre città, nelle nostre case, nelle nostre vite. Creare un nuovo catalogo che comunichi accuratamente lo spirito dei prodotti e l'anima dell'azienda non era un'impresa da poco.

Questo catalogo è il risultato di svariati mesi di riflessione, programmazione, set fotografici, messa in scena e continue modifiche. Uno dei nostri principali obiettivi (tra i tanti) era riuscire a visualizzare il linguaggio, l'atmosfera e i valori del brand attraverso il catalogo. Facendo sì, dunque, che ogni pagina e ogni foto raccontasse i valori e l'estetica dell'azienda. Portare a termine un progetto di tale portata non è certo facile e non può essere fatto da soli. Sono troppe le persone coinvolte ed animate da vivo interesse per poterle nominare una ad una, ma un ringraziamento dovuto va a tutti in azienda, al nostro incredibile team di grafica e fotografia, al team logistico che ci ha seguito in questa avventura.

Circa un anno fa abbiamo inoltre intrapreso la rivisitazione della nostra palette colori; per mesi abbiamo confrontato toni e colori, cercando riferimenti e spunti nella natura, spostato e accostato centinaia di campioni di piccoli vasi per creare una nuova gamma cromatica, che rimanesse fedele a Serralunga 1825 ma che desse per il prossimo decennio nuova forza e slancio ai nostri prodotti. Una palette decisa ma non gridata, con nuovi toni desaturati e naturali, che danno alla plastica una nuova espressione.

La gamma cromatica è stata studiata per la persona, per restituirle la possibilità di giocare con diverse finiture, toni, altezze e forme, alla ricerca della propria interpretazione personale e creativa.

Serralunga 1825 is a family company steeped in history and tradition. Whether on a street corner, terrace or in a courtyard, 1825 products have become integrated into our cities, buildings and lives. Therefore creating a new catalogue that can accurately convey the spirit of its products and the rich soul of the company is no easy feat.

This catalogue is the product of many months of conceptualising, planning, shooting, styling and editing. One of our main tasks (among many) was to manage the visual language, atmosphere and the representation of the brand through this catalogue.



Making sure every page and every shot conveyed the company's values and aesthetics. Undertaking a project of this size is never easy and it can never be done alone. There were too many faces and eager hands involved to name everyone individually but a thank-you must be given to everyone at Serralunga, the logistic team and our excellent photographic and graphic team.

Almost one year ago the revitalisation of our colour palette began, for months we compared tones and combinations, searched for references and carried hundreds of vases to create a new range of colours that

remain true to 1825 but will also carry our products into the next decade with vigour and new life. A palette consisting of desaturated and natural tones that give new expression to plastic.

Our colour palette has been designed for you, to be able to play with different tones, finishes, heights and forms to achieve a more personal, creative and natural effect.

Raffaella Mangiarotti
art director



1825

Nasce la Serralunga, azienda produttrice di cuoio e manufatti nello stesso materiale

Serralunga is founded producing leather goods

1820

1850

1935

La Serralunga inizia a lavorare la gutta-perca e gomma

Serralunga begins working with gutta-percha and rubber

1900

1910

1920

1900

Serralunga partecipa alla 1ª Esposizione Universale di Parigi. Alla stessa Expo Giovanbattista Serralunga partecipa come membro onorario della giuria.

Serralunga attends the First World Expo held in Paris. At the same Expo, Giovanbattista Serralunga becomes an honorary member of the board.



1976

Si passa allo stampaggio rotazionale del polietilene: la Serralunga è la prima in Europa ad importare la tecnologia

Serralunga was the first company in Europe to introduce a new technology called Polyethylene Rotational Molding

1930

1940

1950

1959

Introduzione dello stampaggio ad iniezione della plastica

Introduction of plastic injection moulding

1960

1970

1980

1990

2000

2010

1999

È l'anno dell'introduzione del primo vaso di design

First design pot introduced.

2001

Viene messo in catalogo il primo vaso luminoso

First luminous pot inserted into the catalogue

2006

Vengono inventate le nuove tecniche di rigatura e laccatura

Invention of new lacquered technologies and stripes

2000

Viene presentato il primo vaso fuoriscalda

First out of scale pot presented

2003

Il primo vaso ad entrare in un museo è Serralunga

A Serralunga vase becomes the first vase to be exhibited in a museum



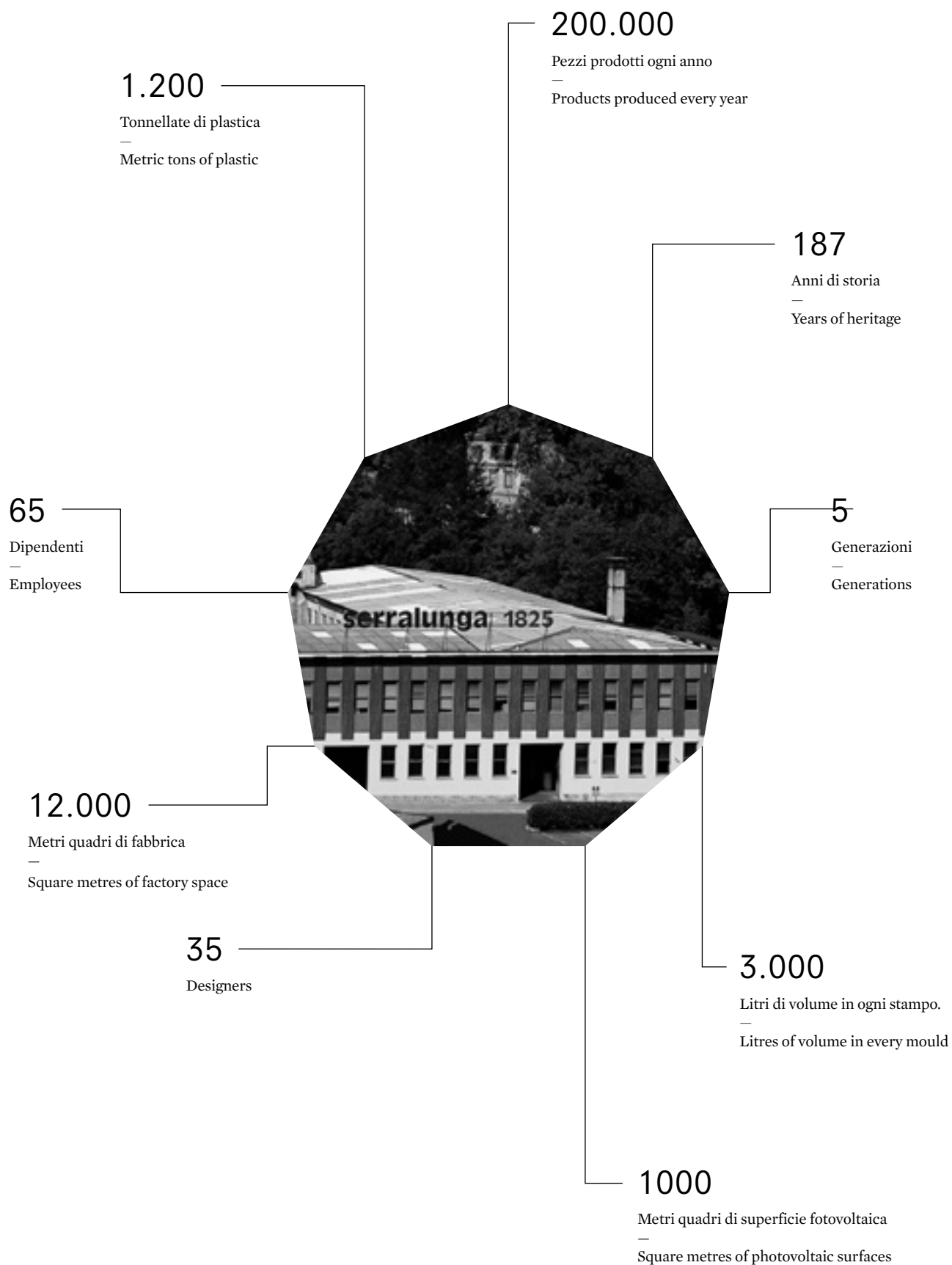

Alice

Design: Patrizia Pozzi

Alice

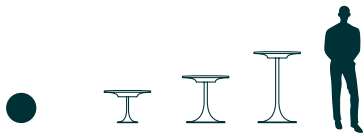

Art.	Size (cm)	h (cm)
Alice Low	72,5	54 / 58,5
Alice High	72,5	71,5 / 76
Alice Extra high	72,5	104 / 108,5









Bay

Design: Raffaella Mangiarotti

Bay



Art.	Size (cm)	h (cm)
Bay	65	70

Bay con luce / with light



Art.	Size (cm)	h (cm)
Bay/L	65	70
Bay/LR	65	70
Bay/LB	65	70













Dado

Design: Fabio Bortolani e Ermanno Righi

Dado



Art.	Size (cm)	h (cm)
Dado	38 x 38	47

Dado con luce / with light



Art.	Size (cm)	h (cm)
Dado/L	38 x 38	47
Dado/LR	38 x 38	47
Dado/LB	38 x 38	47





Giulietta

Design: Paolo Rizzatto

Giulietta



Art.	Size (cm)	h (cm)
Giulietta	186 x 67	100









Lounge cube

Design: Serralunga

ITA

Arredare iconico

Con due sedute e un tavolino sotto un grande albero, c'è un ristorante più bello al mondo?

ENG

Iconic furniture

With two chairs and a small table under a big tree, is there a restaurant as beautiful as this elsewhere in the world?

Lounge cube



Art.	Size (cm)	h (cm)
331	37 x 37	36
351	50 x 50	47

Lounge cube con luce / with light



Art.	Size (cm)	h (cm)
331/L	37 x 37	36
331/LR	37 x 37	36
331/LB	37 x 37	36
351/L	50 x 50	47
351/LR	50 x 50	47
351/LB	50 x 50	47





Lounge Cube



Lounge Cube



Luba

Design: Ionna Vautrin

Luba

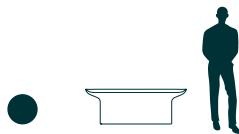

Art.	Size (cm)	h (cm)
Luba	141 x 45,5	49

Luba con luce / with light

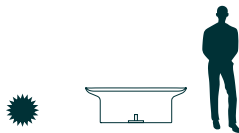

Art.	Size (cm)	h (cm)
Luba/L	141 x 45,5	49
Luba/LR	141 x 45,5	49
Luba/LB	141 x 45,5	49







Luba



Milo

Design: Aquilialberg

Milo



Art.	Size (cm)	h (cm)
Milo	59,5 x 59,5	56

Milo con luce / with light



Art.	Size (cm)	h (cm)
Milo/L	59,5 x 59,5	56
Milo/LR	59,5 x 59,5	56
Milo/LB	59,5 x 59,5	56









Oasis

Design: Sebastian Bergne

Oasis



Art.	Size (cm)	h (cm)
Oasis	115	45

Oasis con luce / with light



Art.	Size (cm)	h (cm)
Oasis/L	115	45
Oasis/LR	115	45
Oasis/LB	115	45





Palenquera

Design: Lina Obregon

Palenquera



Art.	Size (cm)	h (cm)
Palenquera	70 x 30	40

Palenquera con luce / with light



Art.	Size (cm)	h (cm)
Palenquera/L	70 x 30	40
Palenquera/LR	70 x 30	40
Palenquera/LB	70 x 30 <td 40	





Palenquera





Porcino

Design: Aldo Cibic

Porcino



Art.	Size (cm)	h (cm)
Porcino	35	50

Porcino con luce / with light

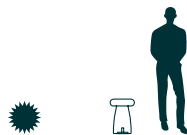

Art.	Size (cm)	h (cm)
Porcino/L	35	50
Porcino/LR	35	50
Porcino/LB	35	50

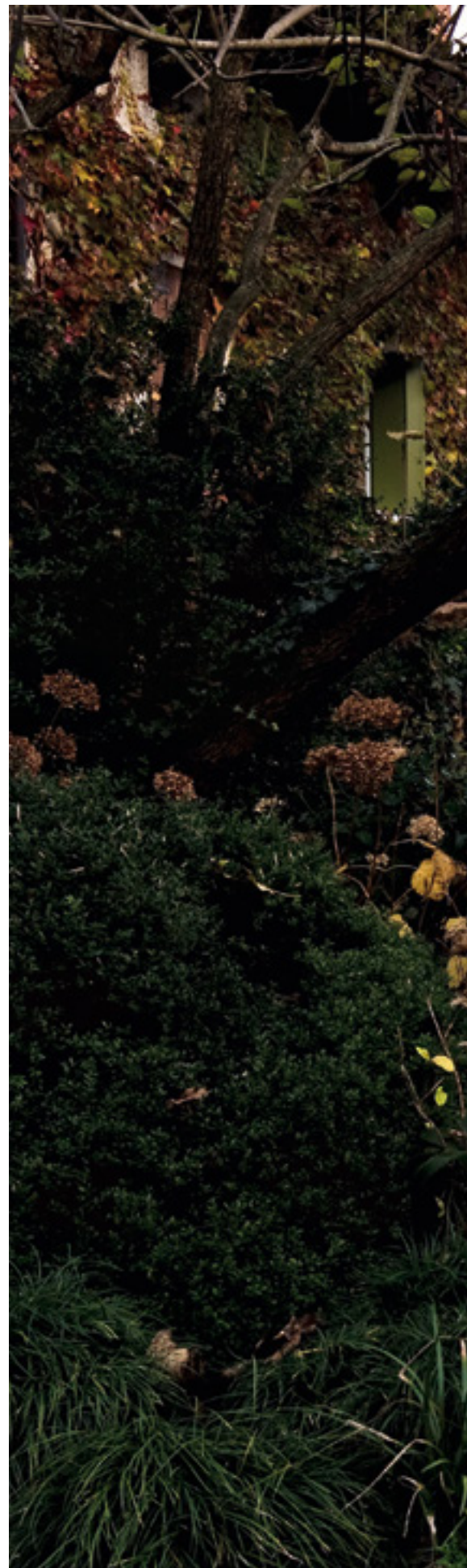



Porcino





Playa

Design: Serralunga



Playa



Art.	Size (cm)	h (cm)
Playa180	100 x 180	75



Rainbow

Design: Serralunga

Rainbow

piano disponibile in tutti i colori standard
top available in all standard colours



Art.	Size (cm)	h (cm)
Rainbow 50	70	56
Rainbow 70	70	71
Rainbow 105	70	106





Rainbow



Rainbow



Romeo

Design: Paolo Rizzatto



Romeo



Art.	Size (cm)	h (cm)
Romeo	115 x 61	96







Sirchester

Design: Bazzicalupo / Mangiarotti

Sirchester Divano / Sofa



Art.	Size (cm)	h (cm)
Sirchester SF	193 x 82	72

Sirchester Divano / Sofa con luce / with light

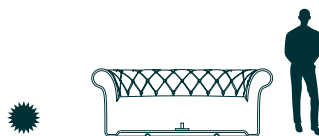

Art.	Size (cm)	h (cm)
Sirchester SF/L	193 x 82	72
Sirchester SF/LR	193 x 82	72
Sirchester SF/LB	193 x 82	72

Sirchester Poltrona / Armchair



Art.	Size (cm)	h (cm)
Sirchester AC	120 x 82	72

Sirchester Poltrona / Armchair con luce / with light



Art.	Size (cm)	h (cm)
Sirchester AC/L	120 x 82	72
Sirchester AC/LR	120 x 82	72
Sirchester AC/LB	120 x 82	72









Atmosfera

Design: Serralunga

ITA

**Metti una sera,
la luna in giardino**

Fare luce vuol dire fare atmosfera, creare pretesti e situazioni. Una cena al chiaro di luna, con il bagliore di una lampada per esterni.

ENG

**Put the moon in your
garden for the night**

To add light means to create the right ambience. A dinner by moonlight with the soft glow of outdoor lamps.

Atmosfera



Art.	Size (cm)	h (cm)
600/L	71	69
600/LR	71	69
600/LB	71	69
601/L	55	53
601/LR	55	53
601/LB	55	53
602/L	40	38
602/LR	40	38
602/LB	40	38









**Ritagliarsi
un momento,
uno spazio
per chiacchierare
a bassa voce,
in tranquillità:
la notte porta
consiglio...**

*Pause a moment,
imagine a space
for quiet conversation
and pensive moments.
When answers
come to light...*





Flame

Design: Sebastian Bergne



Flame



Art.	Size (cm)	h (cm)
Flame/L	50	67,5
Flame/LR	50	67,5
Flame/LB	50	67,5







Pic Nic

Design: Joan Gaspar

Pic Nic



Art.	Size (cm)	h (cm)
Pic Nic/L	49	90
Pic Nic/LR	49	90
Pic Nic/LB	49	90









Bordato Liscio

Design: Serralunga

Bordato Liscio

- 619
- ◆ 614 615 616 617 618 619



Art.	Ø (cm)	h (cm)	Saucer Sottovaso	Int. Ø (cm)	Int. h (cm)	Litres (lt)
614	35,5	31	540	30	29	21
615	46	40	545	38,5	39,5	43
616	58	50	555	49,5	47	85
617	68	60	570	58	56	140
618	78	70	589	67	66	206
619	110	100	513	86	99	490

Bordato Liscio con luce / with light



Art.	Ø (cm)	h (cm)	Int. Ø (cm)	Int. h (cm)	Litres (lt)
616/L	58	50	49,5	24,5	34
616/LR	58	50	49,5	24,5	34
616/LB	58	50	49,5	24,5	34
617/L	68	60	58	32	55
617/LR	68	60	58	32	55
617/LB	68	60	58	32	55
618/L	78	70	67	37	94
618/LR	78	70	67	37	94
618/LB	78	70	67	37	94
619/L	110	100	86	32	130
619/LR	110	100	86	32	130
619/LB	110	100	86	32	130







Bordato Liscio led RGB

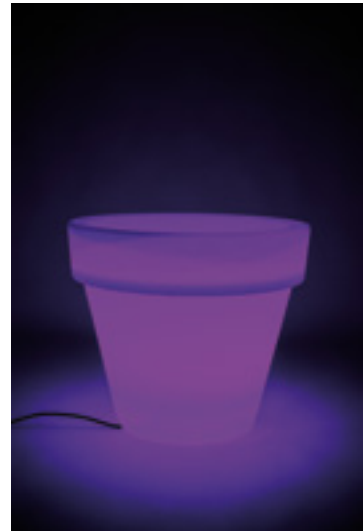



**Giocare con il vintage,
con gli oggetti ri-trovati,
dà un tono di calore al giardino.
Basta poco: un giro al mercato
dell'antiquariato, una lanterna,
una cesta di vimini
o una piccola voliera.**

*By combining vases with vintage
and found objects you can
breathe new life and colour into
your garden. All it takes is a trip to
the antique market, a lantern,
a straw basket or a birdcage.*

**Giocare con
le cromie
per personalizzare
gli spazi.**

*Personalize
your environment
by playing
with colours.*



Camelia

Design: Serralunga

ITA

Affinità elettive

Un vaso dai tratti dolci, femminili. La semplicità senza tempo degli oggetti discreti, che si sposa anche con il segno forte del design contemporaneo.

ENG

Elective affinities

A pot whose salient features are amiable and feminine. Timeless, simple and discreet objects that embrace the strong statement of contemporary design.

Camelia

* Vaso a parete
Wall pot



Art.	Ø (cm)	h (cm)	Saucer Sottovaso	Int. Ø (cm)	Int. h (cm)	Litres (lt)
691*	45 x 30	40	-	38,5 x 26	38	13
693	39,5	35	540	35	34,5	13
694	47	38,5	550	40	38	23
695	51	44	555	45	43,5	29
696	56,5	48	565	50	47,5	37
697	68	59	570	59	58	63
698	53	80	555	45	79,5	68



Cubotti

Design: Nat Wave

ITA

Volumetrie essenziali

La realtà intorno a noi si compone di forme primarie come la sfera, il cilindro, il cono. Alla lezione del grande Cézanne si aggiunge il cubo, seguendo un'ispirazione volumetrica di espressione architettonica.

ENG

Tactile Nuances

The surface, originally smooth, cold and very precise, begins to express its own materiality with all its natural characteristics, and its rough, faded finishes.

Cubotti



Art.	Size (cm)	h (cm)	Int. Size (cm)	Int. h (cm)	Litres (lt)
335	38 x 38	89,5	31 x 31	34,5	16

Cubotti con luce / with light



Art.	Size (cm)	h (cm)	Int. Size (cm)	Int. h (cm)	Litres (lt)
330/L	37 x 37	90	31 x 31	34,5	16
330/LR	37 x 37	90	31 x 31	34,5	16
330/LB	37 x 37	90	31 x 31	34,5	16
335/L	37 x 37	90	31 x 31	34,5	16
335/LR	37 x 37	90	31 x 31	34,5	16
335/LB	37 x 37	90	31 x 31	34,5	16
350/L	50 x 50	45	28 x 28	20	20
350/LR	50 x 50	45	28 x 28	20	20
350/LB	50 x 50	45	28 x 28	20	20
370/L	72 x 72	62	57,5 x 57,5	36,5	64
370/LR	72 x 72	62	57,5 x 57,5	36,5	64
370/LB	72 x 72	62	57,5 x 57,5	36,5	64





Cubotti Deep

Design: Nat Wave

Cubotti Deep



Art.	Size (cm)	h (cm)	Int. Size (cm)	Int. h (cm)	Litres (lt)
318 DEEP	18 x 18	16	18 x 18	11	1
330 DEEP	37 x 37	33	31,5 x 31,5	23,5	19
350 DEEP	50 x 50	44	44 x 44	34	55
370 DEEP	72 x 72	61,5	62 x 62	51	160









Cup

Design: Naoto Fukasawa

ITA

Nuovi paradigmi

Di ispirazione arcaica, come le ciotole scolpite nel legno. Linee pure, per un design semplice, discreto, che ha già il profumo di classico.

ENG

New paradigms

Inspired by ancient wooden bowls. A clean simple and discreet design that already has the making of a classic.



Cup



Art.	Ø (cm)	h (cm)	Saucer Sottovaso	Int. Ø (cm)	Int. h (cm)	Litres (lt)
445	47	25	555	38	20	19
446	48	40	555	40	36	40
447	70	58	-	58,5	51	135



**Leggere sfumature di colore in armonia tra loro,
giochi di chiarezza e di nuove matericità.**



**Light nuances of colour in harmony with each other,
playing with clarity and new materials.**

Il balcone fiorito come soglia: la natura entra in casa e la rinnova con i suoi ritmi e colori, portando luce e vita. Anche in città.



A flourishing balcony acts as a doorway to nature that invigorates your house with rhythm and colour.





Fence

Design: Raffaella Mangiarotti

ITA

Sognando la Francia

Assaggi di Provenza nelle forme tipiche del legno. Un vaso come una staccionata, reinterpretando in chiave moderna la "cassetta" dei fiori.

ENG

Dreaming about France

A taste of provence expressed through the traditional shapes of wood. A vase like a fence, reinterpreting the classic flowerbox.



Fence



Art.	Size (cm)	h (cm)	Saucer Sottovaso	Int. Size (cm)	Int. h (cm)	Litres (lt)
715	100 x 45	60	515	94 x 39	41	240
715 SMALL	45 x 35	60	-	39 x 29	58	80





Fence

ITA Un leggero disegno connota la superficie, rendendola tridimensionale. Un vaso che si accosta facilmente ad ogni stile e ambiente.



ENG A simple design that is characterized by it's surface, making it three dimensional. A vase that effortlessly fits into all styles and environments.





Kabin

Design: Luisa Bocchietto

ITA

Sfumature tattili

La superficie da liscia, fredda e rigorosa torna ad esprimere la sua matericità: evocando la natura e le sue finiture grezze, indefinite.

ENG

Tactile Nuances

The surface, originally smooth, cold and very precise, begins to express its own materiality with all its natural characteristics, and its rough, faded finishes.

Kabin



Art.	Size (cm)	h (cm)	Saucer Sottovaso	Int. Size (cm)	Int. h (cm)	Litres (lt)
KABIN 30	35 x 35	30	–	26 x 26	23	12
KABIN LONG	88 x 44	38	508	76 x 32	30	64
KABIN 39	45 x 45	39	503	35 x 35	31	30
KABIN 50	55 x 55	50	516	46 x 46	40	65
KABIN ALTO	35 x 35	70	–	28 x 28	25	18
KABIN MAXI	44 x 44	100	503	35 x 35	30	20
KABIN EXTRA	75 x 75	150	–	45 x 45	120	175

Kabin con luce / with light



Art.	Size (cm)	h (cm)	Saucer Sottovaso	Int. Size (cm)	Int. h (cm)	Litres (lt)
KABIN ALTO/L	35 x 35	70	–	28 x 28	25	18
KABIN ALTO/LR	35 x 35	70	–	28 x 28	25	18
KABIN ALTO/LB	35 x 35	70	–	28 x 28	25	18
KABIN MAXI/L	44 x 44	110	–	35 x 35	30	20
KABIN MAXI/LR	44 x 44	110	–	35 x 35	30	20
KABIN MAXI/LB	44 x 44	110	–	35 x 35	30	20

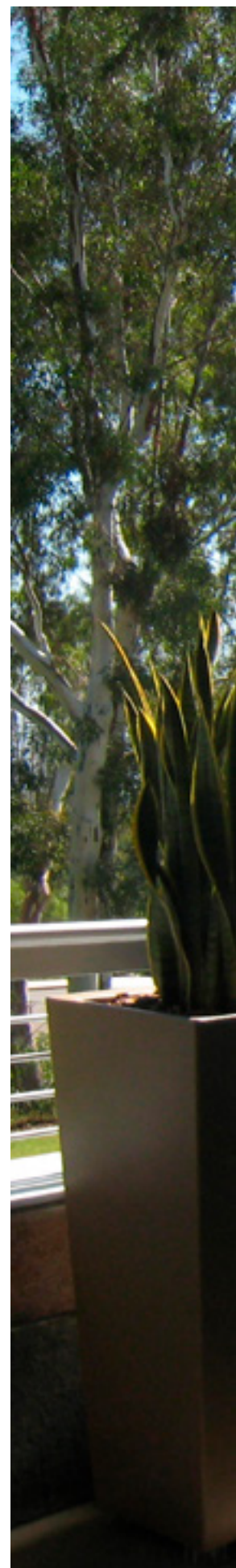











Liscio Siena

Design: Serralunga

ITA

Profumo d'Italia

La bellezza delle proporzioni esatte, in contrasto con una superficie materica e naturale. Terre bruciate e colori in assonanza, con la morbidezza del cotto toscano.

ENG

Scent of Italy

Beautiful and perfect proportions. in contrast to its natural surface. Burned earth and coordinated colours meet the delicacy of true Tuscan Terra-cotta.

Liscio di Siena



Art.	Ø (cm)	h (cm)	Saucer Sottovaso	Int. Ø (cm)	Int. h (cm)	Litres (lt)
391	27	40,5	-	23,5	40	10
392	40	60,5	540	34	59	28
392/smoke	40	60,5	540	34	9,5	-
393	67,5	100	570	55,5	41	70/210
394	52,5	80	555	43,5	32	30/100

Liscio di Siena con luce / with light



Art.	Ø (cm)	h (cm)	Saucer Sottovaso	Int. Ø (cm)	Int. h (cm)	Litres (lt)
393/L	67,5	100	-	55,5	41	70
393/LR	67,5	100	-	55,5	41	70
393/LB	67,5	100	-	55,5	41	70
394/L	52	80	-	43,5	32	30
394/LR	52	80	-	43,5	32	30
394/LB	52	80	-	43,5	32	30









ITA La pelle del vaso è increspata, come fosse lavorata a mano: la particolare lavorazione richiama un aspetto “non finito”.
I toni spazzolati donano al vaso l’eleganza della ceramica.

ENG As if it were a beautiful piece of leather, handmade with a wrinkled pattern: this particular technique makes the pot seem “unfinished” but the brushed effect gives it an elegant ceramic look.

Marcantonio

Design: Serralunga

ITA

Movimento verticale

In un gioco di proporzioni e deformazioni, il vaso a doppio bordo viene reinterpretato, si alza, si stira, si allunga.

ENG

Vertical movement

In a play of proportions and alterations, this double-rimmed pot is reinterpreted. It stands-up and stretches out.

Marcantonio



Art.	Ø (cm)	h (cm)	Saucer Sottovaso	Int. Ø (cm)	Int. h (cm)	Litres (lt)
608	39	90	540	33,5	86	60
608/smoke	39	90	540	32	8	-
611	50	120	-	45	117	130
612	63	150	-	56	144	270

Marcantonio con luce / with light



Art.	Ø (cm)	h (cm)	Saucer Sottovaso	Int. Ø (cm)	Int. h (cm)	Litres (lt)
608/L	39	90	-	33,5	26	11
608/LR	39	90	-	33,5	26	11
608/LB	39	90	-	33,5	26	11
611/L	50	120	-	45	32	30
611/LR	50	120	-	45	32	30
611/LB	50	120	-	45	32	30
612/L	63	150	-	56	38,5	60
612/LR	63	150	-	56	38,5	60
612/LB	63	150	-	56	38,5	60
608smoke/L	39	90	-	32	8	-
608smoke/LR	39	90	-	32	8	-
608smoke/LB	39	90	-	32	8	-

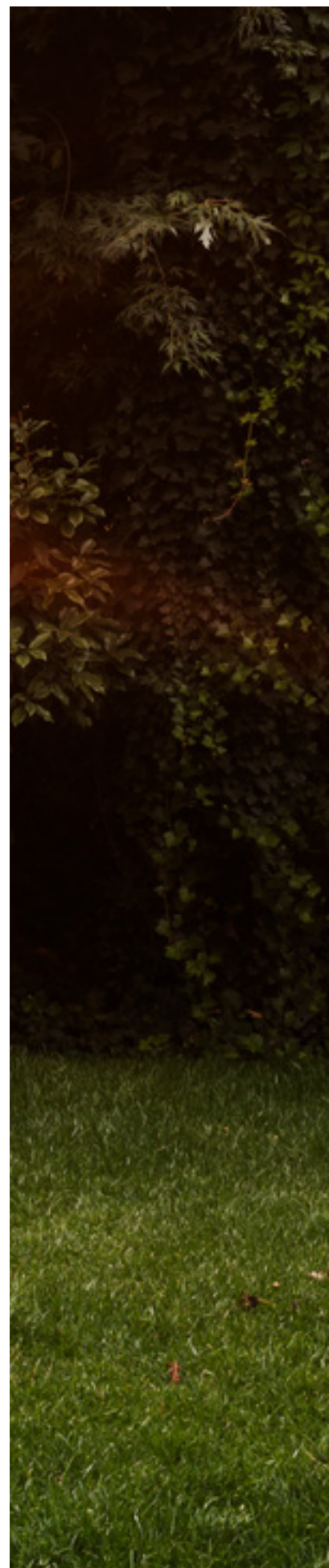



Marcantonio au mur

Design: Serralunga

Marcantonio au mur



Art.	Ø (cm)	h (cm)	Saucer Sottovaso	Int. Ø (cm)	Int. h (cm)	Litres (lt)
611aumur	51,5 x 35	120	-	45x28,5	43	28

Marcantonio au mur con luce / with light



Art.	Ø (cm)	h (cm)	Saucer Sottovaso	Int. Ø (cm)	Int. h (cm)	Litres (lt)
611aumur/L	51,5 x 35	120	-	45x28,5	43	28
611aumur/LR	51,5 x 35	120	-	45x28,5	43	28
611aumur/LB	51,5 x 35	120	-	45x28,5	43	28









Memory Pot

Design: Marta Daza Fernandez

ITA

Imperfetto naturale

Come la terra riarsa, la superficie del vaso si fa screziata, ispirandosi ai celebri mosaici di Gaudì. Per un effetto materico.

ENG

Natural imperfection

Like sun-baked land, inspired by the famous Gaudì mosaics, the surface of the vase becomes veined as if it was real earth.

Memory Pot



Art.	Ø (cm)	h (cm)	Int. Ø (cm)	Int. h (cm)	Litres (lt)
301	49	43	40	22,5	25/70
302	57	77,5	45	44,5	60/180

Memory Pot con luce / with light



Art.	Ø (cm)	h (cm)	Int. Ø (cm)	Int. h (cm)	Litres (lt)
301/L	49	43	40	22,5	25/70
301/LR	49	43	40	22,5	25/70
301/LB	49	43	40	22,5	25/70
302/L	57	77,5	45	44,5	60/180
302/LR	57	77,5	45	44,5	60/180
302/LB	57	77,5	45	44,5	60/180





Memory Pot





Neoclassic

Design: Serralunga

ITA

Il classico contemporaneo

Un vaso dalle linee classiche e rigorose e la scomposta freschezza di una pianta di limoni.

ENG

Contemporary classicism

A vase with classical and conservative lines with the freshness and beauty that comes from the natural irregularity of a lemon tree.

Neoclassic cassetta liscia



Art.	Size (cm)	h (cm)	Saucer Sottovaso	Int. Size (cm)	Int. h (cm)	Litres (lt)
708	80x35	33,5	508	72,5 x 29,5	31,5	72
710	100x47	42	511	91,5 x 39,5	39,5	141

Neoclassic doppio bordo



Art.	Ø (cm)	h (cm)	Saucer Sottovaso	Int. Ø (cm)	Int. h (cm)	Litres (lt)
645	45	40	-	39	39	32
650	50	45	545	44	43,5	49
660	57	50	555	50	48,5	66
670	67	55	570	59,5	53	109
685	85	71	599	77	69	231
1000	100	88	513	91,5	86	415

Neoclassic quadro liscio



Art.	Size (cm)	h (cm)	Saucer Sottovaso	Int. Size (cm)	Int. h (cm)	Litres (lt)
745	47 x 47	42	516	38,5 x 38,5	39,5	67
766	60 x 60	60	-	52,5 x 52,5	57,5	174
788	80 x 80	80	-	70 x 70	76,5	414

**A ciascuna pianta,
il suo vaso: in una moltitudine
di sfumature, proprio
come in natura.**

*Each plant and its vase:
in a multitude of different
shades, just like nature.*







Newpot

Design: Paolo Rizzatto

ITA

Teorie cromatiche

Coniugando la storia ed il contemporaneo si ottiene il meglio da entrambi: come in un'alternanza di normalità e sorpresa, misura e creatività, colore e neutralità.

ENG

Chromatic theories

By combining history and contemporary styles, you can obtain the best of the two: an alternation of usual and unexpected events, moderation and creativity, colour and neutrality.

Newpot



Art.	Ø (cm)	h (cm)	Saucer Sottovaso	Int. Ø (cm)	Int. h (cm)	Litres (lt)
NEWPOT 23	23	23	-	19	21	4
NEWPOT 28	28	28	DINGHY27	23	24	7
NEWPOT 34	34	34	DINGHY27	28	30	12
NEWPOT 40	40	40	DINGHY32	34	35	20
NEWPOT 50	50	50	DINGHY39	42	44	40
NEWPOT 60	60	60	DINGHY49	50	53	65
NEWPOT 70	70	70	DINGHY49	59	61	110
NEWPOT 90	90	90	DINGHY69	75	60	185
NEWPOT ALTO	35	90	DINGHY32	28	35	13
NEWPOT MAXI	44	120	DINGHY39	37	40	40

Newpot con luce / with light



Art.	Ø (cm)	h (cm)	Saucer Sottovaso	Int. Ø (cm)	Int. h (cm)	Litres (lt)
NEWPOT ALTO/L	35	90	-	28	35	13
NEWPOT ALTO/LR	35	90	-	28	35	13
NEWPOT ALTO/LB	35	90	-	28	35	13
NEWPOT MAXI/L	44	120	-	37	40	40
NEWPOT MAXI/LR	44	120	-	37	40	40
NEWPOT MAXI/LB	44	120	-	37	40	40



Newpot



Newpot



Newpot



Newpot



Pot Au Mur

Design: Ecal / Nicolas Le Moigne

Pot Au Mur



Art.	Size (cm)	h (cm)	Int. Ø (cm)	Int. h (cm)	Litres (lt)
Pot Au Mur	47,5 x 45	90	36	40	25







Torre

Design: Serralunga

ITA

Pezzi d'arredo

Anche il vaso più básico può arredare una stanza. Basta una nota di colore e la pianta giusta: giocando con gli accostamenti alla ricerca dell'armonia cromatica.

ENG

Furniture pieces

Even a basic pot can furnish a room. To achieve a chromatic harmony, all that is needed is a touch of colour, the right plant and the proper combination.

Torre



Art.	Size (cm)	h (cm)	Saucer Sottovaso	Int. Size (cm)	Int. h (cm)	Litres (lt)
705	45 x 45	50	504	39 x 39	47,5	80
740	38 x 38	70	503	32,5 x 32,5	66,5	63
749	42 x 42	90	503	35,5 x 35,5	87	120
755	55 x 55	100	516	46 x 46	95,5	200

Torre con luce / with light



Art.	Size (cm)	h (cm)	Saucer Sottovaso	Int. Size (cm)	Int. h (cm)	Litres (lt)
705/L	45 x 45	50	-	39 x 39	25	25
705/LR	45 x 45	50	-	39 x 39	25	25
705/LB	45 x 45	50	-	39 x 39	25	25
740/L	38 x 38	70	-	32,5 x 32,5	30	16
740/LR	38 x 38	70	-	32,5 x 32,5	30	16
740/LB	38 x 38	70	-	32,5 x 32,5	30	16
749/L	42 x 42	90	-	35,5 x 35,5	27	25
749/LR	42 x 42	90	-	35,5 x 35,5	27	25
749/LB	42 x 42	90	-	35,5 x 35,5	27	25
755/L	55 x 55	100	-	46 x 46	40,5	67
755/LR	55 x 55	100	-	46 x 46	40,5	67
755/LB	55 x 55	100	-	46 x 46	40,5	67



**Usare la luce
per segnalare
percorsi, ingressi:
con l'eleganza
e la praticità
di un vaso.**

*You can easily make
path lights and signal
entrances thanks
to your elegant
and practical pots.*



Tubini

Design: Nat Wave

ITA

Basico contemporaneo

Una composizione di figure primarie, di ispirazione volumetrica: forme pure, come architetture industriali semplici ed essenziali.

ENG

Basic contemporaneity

A combination of primary shapes inspired by geometric figures and basic industrial archtypes.

Tubini



Art.	Ø (cm)	h (cm)	Int. Ø (cm)	Int. h (cm)	Litres (lt)
345	50	48	34,5	24	14
346	46	90	31	35,5	16

Tubini con luce / with light



Art.	Ø (cm)	h (cm)	Int. Ø (cm)	Int. h (cm)	Litres (lt)
345/L	50	48	34,5	24	14
345/LR	50	48	34,5	24	14
345/LB	50	48	34,5	24	14
346/L	46	90	31	35,5	16
346/LR	46	90	31	35,5	16
346/LB	46	90	31	35,5	16

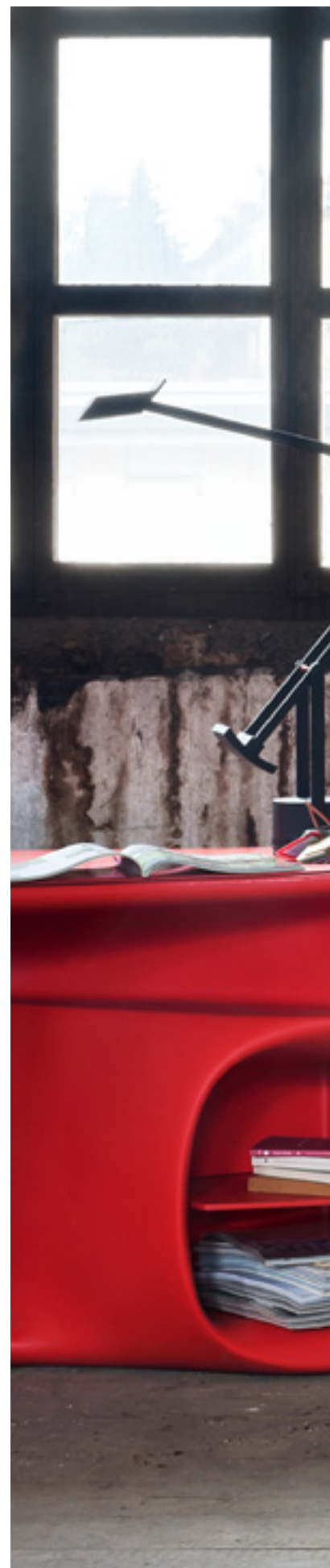





Tubini

ITA Come ricoperta da granelli di sabbia, la superficie di questi vasi fa sua l'ispirazione materica propria dei vasi Serralunga 1825.



ENG As if it was covered in sand, the surface of these pots is perfectly aligned with the philosophy that pertains to Serralunga 1825 and that gives emphasis to the expression of the materials.

Vaso rettangolare O/E

Design: Serralunga

ITA

Confine naturale

Un vaso lungo e sottile può creare ambienti e dividerne altri: un separè verde, come una porta tra il dentro e il fuori.

ENG

Natural boundary

A long and thin pot can create environments and separate some others: a green divider, just like a door between indoor and outdoor.

Vaso rettangolare O/E



Art.	Size (cm)	h (cm)	Int. Size (cm)	Int. h (cm)	Litres (lt)
722	93,5x26,5	70	86,5x19,5	16	18/155

Vaso rettangolare O/E con luce / with light



Art.	Size (cm)	h (cm)	Int. Size (cm)	Int. h (cm)	Litres (lt)
722/L	93,5 x 26,5	70	86,5 x 19,5	16	18/155
722/LR	93,5 x 26,5	70	86,5 x 19,5	16	18/155
722/LB	93,5 x 26,5	70	86,5 x 19,5	16	18/155







Vaso rettangolare O/E



Decorati

Design: Serralunga

ITA

New bucolics

I vasi di sempre, belli come sempre. Anzi, di più: colori pastello tono su tono creano nuove atmosfere bucoliche, tra il giardino all'inglese e la campagna italiana.

ENG

New bucolics

Everlasting pots, as beautiful as always and now even more: by matching pastel colours you can create new country environments somewhere between English gardens and the Italian countryside.



















Scheda tecnica

Technical information

Decorati / Calice decorato

Design Serralunga



Art.	Ø (cm)	h (cm)	Saucer Sottovaso	Int. Ø (cm)	Int. h (cm)	Litres (lt)
231	42	38	-	29,5	37	12

Decorati / Calice fogliato

Design Serralunga



Art.	Ø (cm)	h (cm)	Saucer Sottovaso	Int. Ø (cm)	Int. h (cm)	Litres (lt)
229	50	60	-	37	55	25

Decorati / Cassetta fogliata

Design Serralunga



Art.	ø (cm)	h (cm)	Saucer Sottovaso	Int. Size (cm)	Int. h (cm)	Litres (lt)
450	51,5x19,5	18,5	450/S	48 x 16,5	17,5	12
460	60x30	27	506	57 x 26	25	30
470	70x32	28,5	507	67 x 29	27	40

Decorati / Ciotola Giulia

Design Serralunga



Art.	Ø (cm)	h (cm)	Saucer Sottovaso	Int. Ø (cm)	Int. h (cm)	Litres (lt)
227	66	25	540	57	22	20

Decorati / Colonna foglie

Design Serralunga

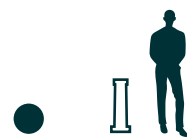

Art.	Ø (cm)	h (cm)	Saucer Sottovaso
309	35x35	75	-
309 smoke	35x35	75	-



Decorati / Festonato

Design Serralunga



Art.	Ø (cm)	h (cm)	Saucer Sottovaso	Int. Ø (cm)	Int. h (cm)	Litres (lt)
935	35	30	540	28,5	28,5	11
940	40	35	540	33	34,5	20
945	45	40	545	37	39	30
950	50	45	550	44	43	40
955	55	46	555	48	45	51
965	65	55	565	57	53	85
975	75	60	589	67	61	130
999	100	80	599	87	78	280

Decorati / Festonato maior

Design Serralunga



Art.	Ø (cm)	h (cm)	Saucer Sottovaso	Int. Ø (cm)	Int. h (cm)	Litres (lt)
994	130	82	513	116,5	80	500

Decorati / Orcio

Design Serralunga



* Con cachepot with Cachepot



Art.	Ø (cm)	h (cm)	Saucer Sottovaso	Int. Ø (cm)	Int. h (cm)	Litres (lt)
904*	54	68	-	26	24	10
907*	68	75	-	29	24	15

Decorati / Orcio festonato

Design Serralunga



Art.	Ø (cm)	h (cm)	Saucer Sottovaso	Int. Ø (cm)	Int. h (cm)	Litres (lt)
903	60	50	555	41	48,5	70

Decorati / Quadro fiore

Design Serralunga



Art.	Size (cm)	h (cm)	Saucer Sottovaso	Int. Size (cm)	Int. h (cm)	Litres (lt)
988	35 x 35	32	503	26,5 x 26,5	31,5	35
981	42 x 42	40	504	31 x 31	38,5	65

Decorati / Rettangolo festonato

Design Serralunga



Art.	Size (cm)	h (cm)	Saucer Sottovaso	Int. Size (cm)	Int. h (cm)	Litres (lt)
985	50 x 22	24	505	42,5 x 19	21,5	15
906	60 x 30	25	507	52,5 x 24	21,5	27
980	80 x 35	32	508	69 x 25	32	50
910	100 x 42	40	510	88 x 32	38,5	110

Decorati / Uva spina

Design Serralunga



Art.	Ø (cm)	h (cm)	Saucer Sottovaso	Int. Ø (cm)	Int. h (cm)	Litres (lt)
441	42	32	540	34,5	30,5	21
451	52	40	550	44	38	38

Graniglia

Design: Serralunga

ITA

Sfumature tattili

La superficie da liscia, fredda e rigorosa torna ad esprimere la sua matericità: evocando la natura e le sue finiture grezze, indefinite.

ENG

Tactile Nuances

The surface, originally smooth, cold and very precise, begins to express its own materiality with all its natural characteristics, and its rough, faded finishes.





ITA

La texture riporta alla memoria dei vasi antichi, all'enfasi della materia e alla bellezza della pietra.

ENG

This texture reminds you of ancient pots, an extravagant taste that highlights its own material and emphasizes the beauty of stone.

Graniglia / Ciotola ruvida



Art.	Ø (cm)	h (cm)	Saucer Sottovaso	Int Ø (cm)	Int. h (cm)	Litres (lt)
251	42	20	540	36,5	19	10
252	51	24	545	46	22	20



Graniglia / Rettangolare ruvida

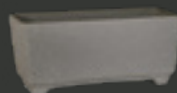

Art.	Size (cm)	h (cm)	Saucer Sottovaso	Int. Size (cm)	Int. h (cm)	Litres (lt)
260	60 x 25	30	506	53 x 20,5	27	28
280	80 x 31	35	508	71 x 24,5	31	56



POTS

Millerighe

Design: Serralunga

ITA

L'utile e il dilettevole

Un classico che resta, sempre. È il colore che fa la differenza: picchi cromatici e toni su tono, per accostamenti seriali inaspettati.

ENG

Duty and pleasure

An everlasting classic. Here the colour makes the difference: chromatic highlights and matching tones mixed together for unexpected combinations.



Scheda tecnica

Technical information

Millerighe alto

Design Serralunga



Art.	Size (cm)	h (cm)	Saucer Sottovaso	Int. Size (cm)	Int. h (cm)	Litres (lt)
846	42x42	54	504	37 x 37	57	70

Millerighe angolo

Design Serralunga



Art.	Size (cm)	h	Saucer Sottovaso	Int. Size (cm)	Int. h (cm)	Litres (lt)
845	41 x 41	60	-	48,5 x 34	52,5	48

Millerighe angolo orizzontale

Design Serralunga



Art.	Size (cm)	h (cm)	Saucer Sottovaso	Int. Size (cm)	Int. h (cm)	Litres (lt)
849	43 x 43	40	-	51,5 x 36,5	37	40

Millerighe parete
Design Serralunga



Art.	Size (cm)	h (cm)	Saucer Sottovaso	Int. Size (cm)	Int. h (cm)	Litres (lt)
865	61 x 35	54	-	54 x 29	51,5	55

Millerighe quadrato
Design Serralunga



Art.	Size (cm)	h (cm)	Saucer Sottovaso	Int. Size(cm)	Int. h (cm)	Litres (lt)
830	35 x 35	35	503	30 x 30	32,5	28
840	43 x 43	40	504	38 x 38	38,5	50
805	50 x 50	50	516	45 x 45	48	90

Millerighe rettangolare
Design Serralunga



Art.	Size (cm)	h (cm)	Saucer Sottovaso	Int. Size(cm)	Int. h (cm)	Litres (lt)
850	50x22	23	505	44x17	22	12
860	60x28	27	506	54,5 x 22,5	24,5	26
808	83x35	35	508	74,5x28	33	70
810	100x43	40	510	91x35	37,5	110
815	110x50	50	515	107,5 x 45	47,5	180

Informazioni
tecniche

Technical
information

Colori Standard / Standard Colors



Bianco
WH



Neutro Luce
NT



Neve di San Candido
IWH

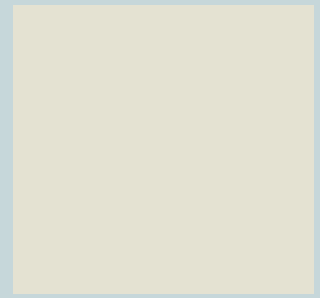

Gesso di Bologna
WH5

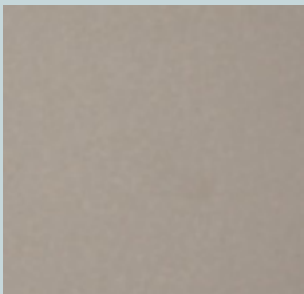

Tortora di Torino
TO

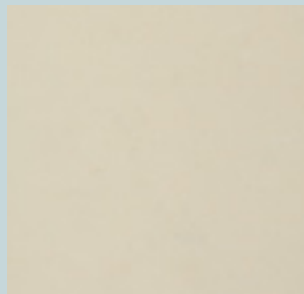

Pietra di Matera
IV AV



Coffee Delavè
ICA *

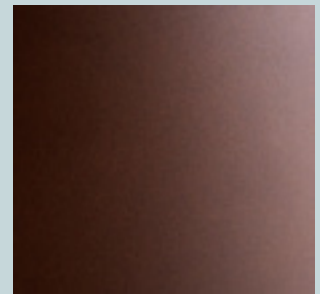

Corten
COR *

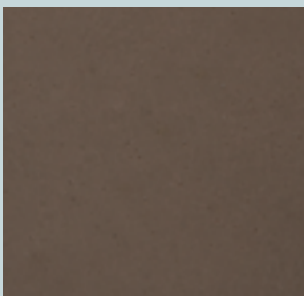

Castoro
TC2

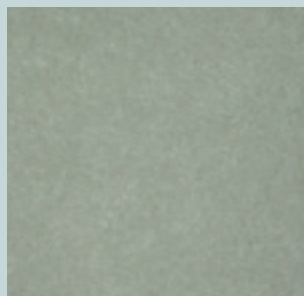

Pietra delle Dolomiti
GG

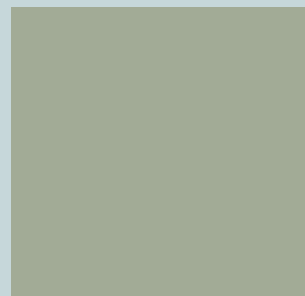

Salvia di Sardegna
SAV

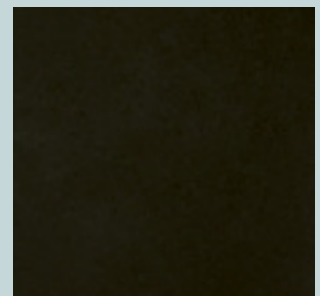

Antracite di Sardegna
ANT



More di Rovo
BK

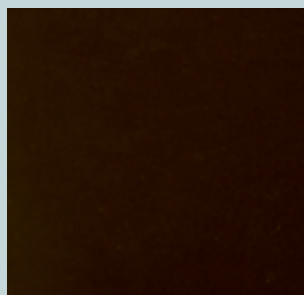

Terracotta scura
TC4



Impruneta classica *
IMP

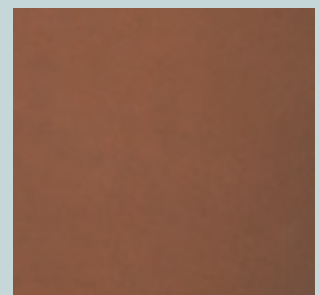

Terracotta Toscana
TC



Verde Pavone
WP

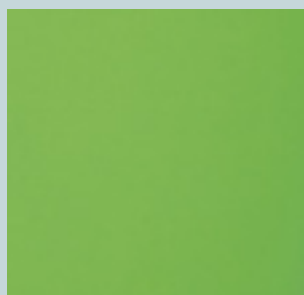

Apple Green
AG

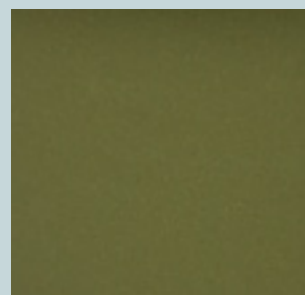

Olive di Cerignola
VOC

* finitura spatolata non uniforme
irregular spatula finish not
uniform

Colori / Colors

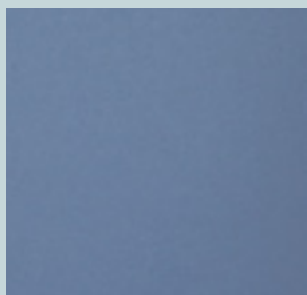

Acqua della Maddalena
AQM



Azzurro di Provenza
AZP

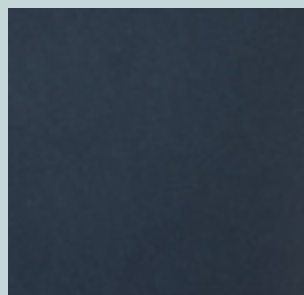

Blu di Portofino
BLP

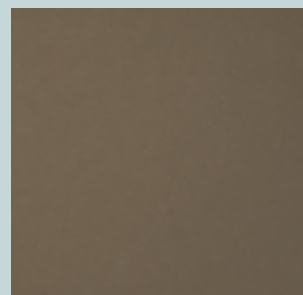

Origano di Sardegna
VMA



Rosso
RO



Corallo
COL

Special nuances

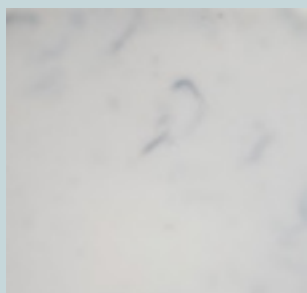

Marmo
MAR

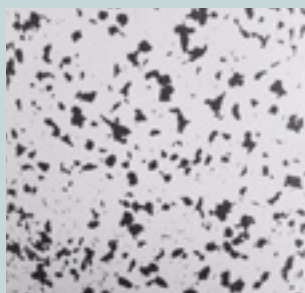

Patchy
WB

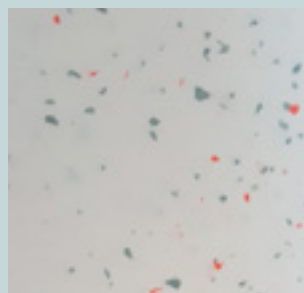

Patchy
WAC



Eco
ECO



Dalmata
DAL

Finiture superficiali / Surface finishing



Superficie liscia
Smooth surface



Superficie graffiata
Scratched surface

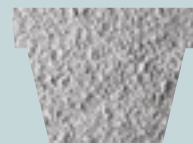

Superficie Ruvida
Rough surface



Lampada a bulbo
Light bulb
(L)

Colorazione / Color 6400°K



Led
Led
(LED)

Colorazione / Color tra 6000 e 6500°K



Led Ricaricabile
Rechargeable led
(LB)

Colorazione / Color tra 5800 e 6500°K

Istruzioni per invasatura / Potting instructions

— Interno

Riempire il vaso con 1/3 in altezza di argilla espansa, posizionare uno strato di tessuto drenante e completare il riempimento con terriccio idoneo per la pianta da invasare. L'argilla espansa svolge la funzione di riserva d'acqua, trattenendo l'umidità in eccesso e rilasciandola nel caso essa sia insufficiente.

— Indoor

Fill the pot with 1/3 in height of expanded clay, put a draining cloth and complete filling with soil suitable for the plant to pot. Expanded clay has the function of water reservoir, holding excess wet and releasing it in case it is insufficient.



— Outdoor

Il nostri vasi possono anche essere utilizzati come dei vasi di terracotta, praticando con un comune trapano un foro sul fondo del vaso (foratura Ø 6 mm circa). I vasi in doppia parete devono essere forati nella parte interna e sul fondo.

— Outdoor

Our pots can be used like terracotta pots, drilling the bottom part (hole Ø about 6 mm). Double wall pots must be drilled in the inner and in the bottom part.

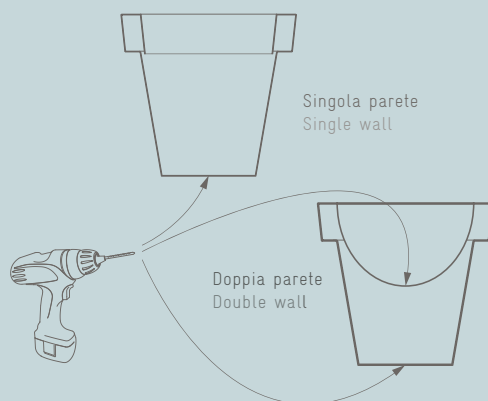

— Portavaso

Infine i nostri vasi possono essere utilizzati come cachepot (portavaso). Sugeriamo l'utilizzo di un semplice vaso iniezione (plastica) con relativo sottovaso (opzionale).

— Cachepot

Finally, our pots can be used like cachepot. We suggest the use of an injection pot with relative saucer (optional).

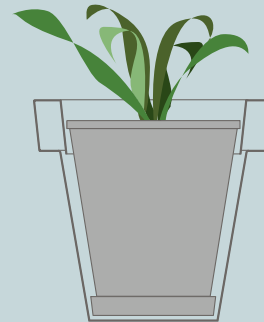

— Cubotti Deep

I Cubotti Deep, oltre a poter essere utilizzati per indoor, outdoor e come cachepot, hanno la possibilità di fungere da riserva d'acqua. In questo caso è necessario forare in più punti la parte interna del vaso (foratura Ø 6mm circa) e procedere all'invasatura indoor.

Questi vasi sono predisposti con un foro per il rabbocco dell'acqua, che può essere utilizzato anche per l'alloggiamento di un indicatore di livello.

— Cubotti Deep

Cubotti Deep, besides being able to be used for indoor, outdoor and like cachepot, can be used like a water reservoir. In this case you have to drill in more points the inner part of the pot (hole Ø about 6 mm) insert expanded clay, a draining cloth and then soil suitable for potting the plant. This vases are designed with a hole for refill water, that can be used to contain a water-level indicator.

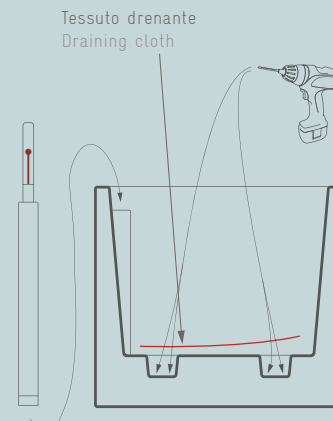

Foro per il rabbocco dell'acqua e l'alloggiamento del galleggiante (non fornibile)

Hole for water refilling and containing the water-level indicator (not included)

Drenaggio e fissaggio a terra / Water drainage and ground fixing

— Sistema di drenaggio

Tutti i vasi illuminati sono dotati di sistema per il drenaggio dell'acqua. Rimuovere il tappo all'interno del vaso per far defluire l'acqua.

— Water drainage system

All illuminated pots are equipped with a water drainage system. Remove the inner stopper to drain water.

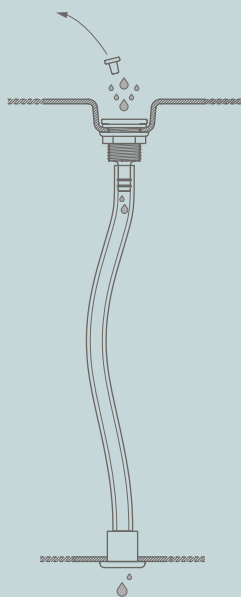

— Fissaggio a terra

I prodotti possono essere fissati a terra tramite piastre in acciaio inox AISI 316. I tasselli per l'ancoraggio non sono inclusi nel kit, ma devono essere acquistati in base al tipo di pavimentazione su cui si desidera fissare il prodotto.

Si consigliano 3 piastre per i vasi tondi e 2/4 piastre per i vasi quadrati e rettangolari.

— Ground fixing

Products can be fixed to the ground with AISI 316 stainless steel plates. Rawplugs are not included in this kit, they must be bought according to the ground where you want to fix the product.

We suggest 3 plates for round pots and 2/4 plates for square and rectangular pots.

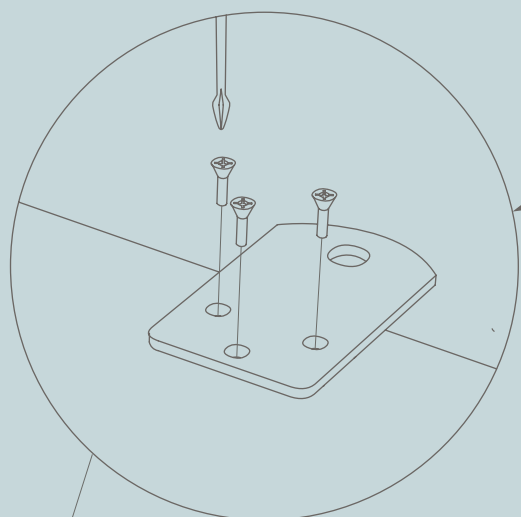
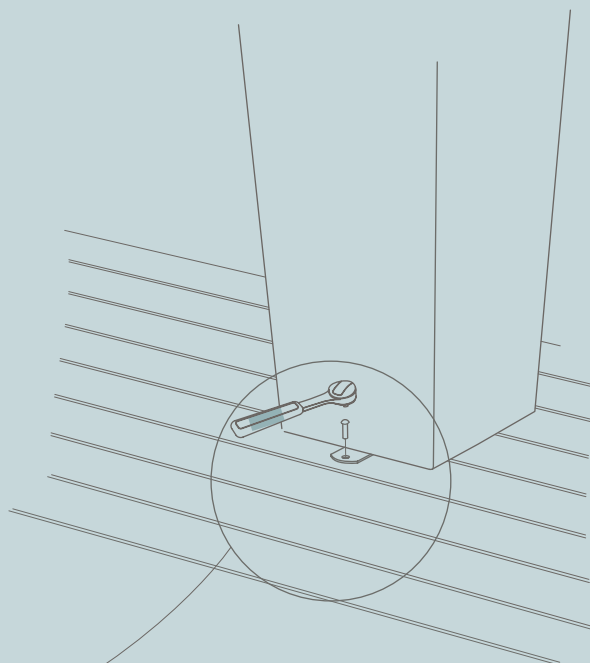

Fondo del vaso
Pot's bottom

Material / Material

— Resistenza UV

I nostri colori sono resistenti all'azione sbiadente provocata dai raggi UV della luce solare.

— UV resistance

Our colours are resistant to fading action caused by solar light's UV rays.

— Resistenza agli urti

La struttura molecolare del PE polietilene rende i manufatti stampati con questo materiale naturalmente resistenti agli urti.

— Collision Resistance

The molecular structure of PE polyethylene makes products moulded with this raw material naturally collision-proof.

— Resistenza termica

I nostri prodotti resistono ad un ampio range di temperature e si adattano bene all'uso outdoor in tutte le stagioni.

— Thermal Resistance

Our products resist a large temperatures' range and they are suitable for outdoor usage in all seasons.

— 100% Riciclabili

Il PE polietilene utilizzato per realizzare i nostri prodotti è completamente riciclabile.

— 100% Recyclable

PE polyethylene used for realize our products is totally recyclable.

— Manutenzione

Evitare accumuli di polvere o di sporco sulle superfici e pulire periodicamente il prodotto con un panno umido imbevuto di sapone di marsiglia o detersivi liquidi neutri, meglio se diluiti in acqua. Evitare l'uso di alcool etilico o di detersivi contenenti, anche in piccole quantità, acetone, trielina ed ammoniaca (solventi in generale).

La finitura laccata (disponibile solo per alcuni articoli) può essere utilizzata all'esterno ma è più sensibile ai graffi; per questo motivo utilizzare una pasta tipo Polish, strofinando delicatamente con ovatta.

— Maintenance

Remove dust and dirty from plastic surfaces and clean periodically the product with a damp cloth soaked in neutral liquid soap, better if diluted in water. Avoid the use of ethanol or any liquid containing, even in small amounts, acetone, trichloroethylene and ammonia (solvents in general). Laquered finish is suitable for outdoor usage, but it is more sensitive to scratches; for this reason use a polish cleaner, cleaning gently with a soft tissue.

— Fissaggio Marcantonio au mur

Il vaso viene fornito con due ganci in acciaio inox AISI 316. È resistente agli agenti atmosferici, al cloro, anti-corrosione, adatto in ambiente salino. Tasselli a muro non compresi. Acquistate i tasselli più adatti al tipo di muro su cui andrete a fissare il vaso (mattoni forati, calcestruzzo, cartongesso, etc.).

— Marcantonio au mur wall fixing

The pot is provided with a hook in stainless steel AISI 316. It's resistant to wheather, chlorine, corrosion and suitable in saline environment. Nogs not included.

Buy the nogs suited for the type of wall on which you are going to fix the pot (bricks, concrete, plasterboard, etc.).

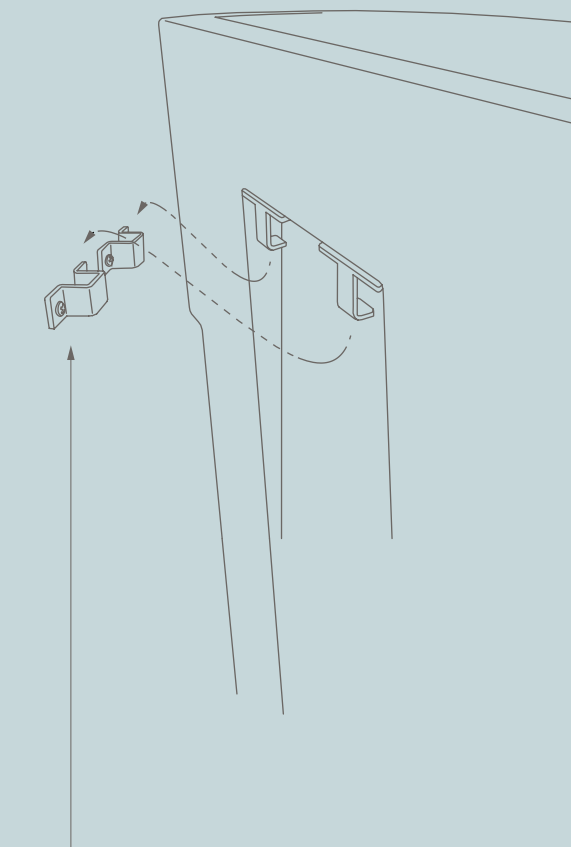

Fissare i ganci al muro

Fix hooks to the wall

Impianti luce / Lighting systems

— Impianto luce a risparmio energetico

Energy saving bulb 20W (E27) - 220/240V (110/220V) - 50/60HZ-Class II

Cavo nero 3 m

Lampadina fornita non assemblata

Protezione IP67

— Energy saving lighting system

Energy saving bulb 20W (E27) - 220/240V (110/220V) - 50/60HZ-Class II

3 m black wire

Bulb included but not assembled

IP67 protection

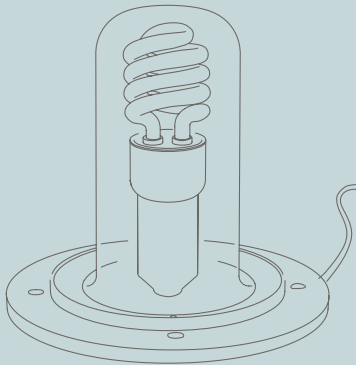

— Impianto luce led RGB

9W RGB LED - 100/240V - 50/60Hz - Class II

cavo nero 3 m

Lampada fornita non assemblata

Pilotabile con telecomando a RF per sequenza colori

Protezione IP67

— RGB led lighting system

9W RGB LED - 100/240V - 50/60Hz - Class II

3 m black wire

Led bulb included but not assembled

Operated by RF remote control for colours sequence

IP67 protection

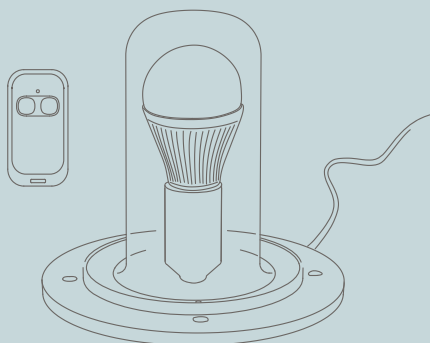

— Impianto luce led RGB wireless Bluetooth (Energy A class).

1,2 W RGB LED - batteria al litio 3.7 V, 1750 mAh.

Autonomia: fino a 20 ore.

Tempo ricarica: 6 ore.

Stazione di ricarica: input AC 100-240 V - 50/60 Hz,

Output DC 5 V - PER USO INTERNO.

Pilotabile con app da cellulare per sequenza colori, oppure con pulsanti sul fondo dell'impianto.

Protezione IP68.

— Wireless RGB Bluetooth led lighting system (Energy A Class).

1,2 W RGB LED - lithium battery 3.7 V, 1750 mAh.

Autonomy: up to 20 hours.

Charging time: 6 hours.

Charging station: AC input 100-240 v - 50/60 hz,

DC output 5 v - for indoor usage.

Operated by mobile app for colours sequence or buttons on the bottom of the lighting system.

IP68 Protection

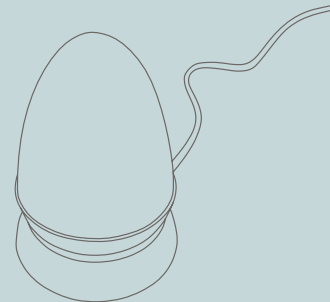

Protezione IP67: Protezione totale alla penetrazione di corpi solidi e polveri. Protezione contro l'immersione momentanea in acqua per 30 minuti ad 1 metro di profondità.

Protezione IP68: Protezione totale alla penetrazione di corpi solidi e polveri. Protezione contro l'immersione permanente in acqua ad 1 metro di profondità.

IP67 protection: total protection against solid corps and powders penetration. Protection against water immersion for 30 minutes at 1 meter deep.

IP68 protection: total protection against solid corps and powders penetration. Protection against permanent water immersion at 1 meter deep.

Colophon

Serralunga s.r.l.

Via Serralunga, 9
13900 Biella
Tel. +39 0152435711
Fax +39 01531081
info@serralunga.com

Outlet

Via Serralunga 9
13900 Biella
Tel. +39 0152435711
info@serralunga.com

Photography

Federico Villa
Steve Wilson
Andrea Tonella
Archivio Serralunga

Location

Biella: Castello di Moncavallo di Vigliano
Biellesse, Palazzo Lamarmora, Serralunga srl.
Milano: Arbol Gallery Milano, Biblioteca
della moda, Ristorante 4cento, Ristorante
l'Assassino.
Novara: Agriturismo La capuccina.

Printed

©2019, Serralunga
100% made in Italy

Serralunga è membro ADI Associazione per
il Disegno Industriale.

—

Serralunga is member of ADI Industrial
Design Association.

I prodotti Serralunga sono stati esposti in
numerosi musei e collezioni permanenti tra
le quali: Serpentine Gallery London, Musée
d'art contemporain di Montreal, Centre
George Pompidou a Parigi, Museo del design
Triennale di Milano, Museo d'Arte Moderna
di Trieste.

—

Serralunga vases have been exhibited
and included in museums and permanent
collections world wide including: Serpentine
gallery London, Musée d'art contemporain
de Montreal, Centre George Pompidou Paris,
Triennale Design Museum Milano, Modern
Art Museum Trieste.



SERRALUNGA

www.serralunga.com