



**design
collection**

SERRALUNGA
MADE IN ITALY Since 1825

Ogni anima ha un suo luogo in cui si placa.
Io immagino degli spazi in cui i miei oggetti restituiscano un senso di quiete e una sensazione di bellezza in un ambiente naturale.
Questo è il sogno che guida il mio fare quotidiano:
un confine fluido tra l'esterno e l'interno, dove l'esterno diviene intimo e l'interno luminoso e solare, mescolando le carte e creando l'inaspettato. Emozionalmente.

Every soul has a place of calm.
I imagine spaces in which my objects give a sense of peace and beauty in a natural environment.
This is the dream that guides my daily work:
a fluid boundary between indoors and outdoors where the outside becomes intimate and the inside bright and sunny, mixing things up to create the unexpected. Emotionally.

Il y a un lieu où chaque âme s'apaise.
Moi j' imagine des espaces où mes objets donnent un sens de calme et une sensation de beauté, dans un milieu naturel.
Le rêve qui guide mon activité quotidienne est une limite fluide entre l'extérieur et l'intérieur, où l'extérieur devient intime et l'intérieur lumineux et solaire.
Mélanger les cartes en créant l'inattendu. Emotionnellement.

Jede Seele hat ihren eigenen besonderen Ort,
an dem sie Ruhe findet. Ich stelle mir Orte vor, in denen meine Objekte in einer natürlichen Umgebung ein Gefühl der Ruhe und Schönheit wiedergeben.
Das ist der Traum, der mich den Alltag hindurch begleitet: ein fließender Übergang zwischen dem Äußeren und dem Innerem, wo das Äußere intim und das Innere hell und freundlich wird, die Karten neu gemischt werden und das Unerwartete geschaffen wird. Auf emotionale Weise.



MS
Marco Serralunga

SERRALUNGA, A PASSION FOR INNOVATION.

3

Con la sua propensione all'innovazione, Serralunga è nota per spingersi al di là dei limiti dei materiali, delle tecnologie e delle forme, per arrivare a creare prodotti innovativi, fonte di ispirazione e di piacere alla vista. Che si tratti di un vaso scultoreo, di un tavolo geometrico, o di un lettino da esterni minimalista, i prodotti Serralunga catturano l'attenzione e sono concepiti per essere tanto funzionali quanto affascinanti, attestando l'eccellente capacità di lavorazione nel campo delle plastiche e dello stampaggio rotazionale. L'alta qualità e la resistenza agli agenti atmosferici di questi prodotti permettono di instaurare una progressione naturale e impercettibile tra spazi interni ed esterni, allargando sensibilmente gli ambienti in cui viviamo. Negli ultimi anni, il presidente dell'azienda, Marco Serralunga ha commissionato nuovi progetti ai più importanti architetti e designer internazionali al fine di creare oggetti che si contraddistinguono per la loro eleganza e la loro modernità; tra questi: Zaha Hadid, Philippe Starck e Jean-Marie Massaud. I prodotti rimandano a un lusso discreto e si distinguono per un raro senso di armonia che permette loro di essere abbinati con accostamenti intriganti, a volte quasi teatrali. La loro forte presenza scultorea riesce a conferire una forte caratterizzazione e connotazione agli spazi, descrivendo una bellezza affine ad ambienti esterni ed interni. Grazie ai suoi prodotti design-oriented, Serralunga continua la tradizione di eccellenza che da sempre è associata al marchio Made in Italy, creando al tempo stesso nuovi modi di vivere che ci permettono di rilassarci e riposare con arredi che arricchiscono funzionalmente e semanticamente la nostra vita.

Avec sa passion pour l'innovation, Serralunga est célèbre pour aller au-delà des matériaux, des technologies et de l'esthétique afin de créer des produits innovateurs, source d'inspiration et de satisfaction. Lameublement séduisant produit par la société, qu'il s'agisse d'un vase sculptural, d'une table géométrique ou d'un transat minimaliste, est conçu pour non seulement être hautement fonctionnel mais également beau, et confirme la maîtrise suprême de l'entreprise dans l'utilisation de nouveaux polymères synthétiques et de procédés de moulage à l'avant-garde. De façon significative ces projets de grande qualité et résistants aux agents atmosphériques permettent une progression visuelle naturelle et sans bornes entre espaces internes et externes, en élargissant ainsi considérablement nos espaces de vie. Au cours des dernières années le président de la société, Marco Serralunga, a commandé la création de pièces incroyablement originales à quelques-uns des plus importants architectes et designers du monde, tels que Zaha Hadid, Philippe Starck et Jean-Marie Massaud, des pièces qui se distinguent par leurs formes élégantes et modernes. En dégagant un luxe discret, les produits Serralunga sont caractérisés par un sens rare d'harmonie qui leur permet d'être regroupés de manières intrigantes et souvent absolument spectaculaires. Leur présence sculpturale accentuée aide en outre à apporter une identité au caractère fort aux espaces où ils se situent, en garantissant dans le même temps que les projets soient beaux, à l'intérieur comme en plein air. C'est à travers ses produits orientés vers le design que Serralunga perpétue l'excellence qui a été longtemps associée à l'étiquette du "Made in Italy". L'entreprise offre dans le même temps de nouveaux modes de vie qui nous permettent de nous reposer et de nous relaxer dans des décors qui, en définitive, enrichissent notre vie.

BY CHARLOTTE
AND PETER FIELL

With its passion for innovation, Serralunga is renowned for pushing the boundaries of materials, technologies and aesthetics in order to create groundbreaking products that both inspire and delight. The company's eye-catching furnishings whether a sculptural planter, geometric table or minimal sun-bed are conceived to be highly functional as well as beautiful, and attest to the firm's supreme mastery of new synthetic polymers and cutting-edge moulding processes. Significantly, these high-quality weather-resistant designs enable a natural and almost seamless visual progression from indoor to outdoor spaces, thereby considerably extending our living environments. Over recent years, the company's president, Marco Serralunga, has commissioned some of the world's leading architects and designers such as Zaha Hadid, Philippe Starck and Jean-Marie Massaud to create strikingly original pieces that are distinguished by their elegant yet modern forms. Exuding an understated luxury, Serralunga's products are marked by a rare sense of harmony that enables them to be grouped together into intriguing and often quite dramatic arrangements. Their strong sculptural presence also helps provide a characterful identity to the environments in which they are placed, whilst ensuring the designs look as good indoors as they do outdoors. Through its design-orientated products, Serralunga perpetuates the excellence that has long been associated with the "Made in Italy" label, while at the same time offering new ways of living that allow us to rest and relax with furnishings that ultimately enrich our lives.

Serralunga ist dafür bekannt, aufgrund seiner angeborenen Leidenschaft für Innovation, über die von den Werkstoffen, Technologien und von der Ästhetik gesetzten Grenzen hinauszugehen, um innovative Produkte zu erschaffen, die Freude bereiten und inspirieren. Sei es ein gigantischer Topf, ein geometrischer Tisch oder ein minimalistisch gehaltenes Bett - die ansprechenden Einrichtungsgegenstände, die von diesem Unternehmen hergestellt werden sind außerordentlich funktionell und ästhetisch eindrucksvoll und bestätigen gleichzeitig die hohe Begabung des Unternehmens im Gebrauch neuer synthetischer Polymere und fortschrittlicher Pressverfahren. Diese qualitativ hochwertigen und wetterbeständigen Produkte ermöglichen einen natürlichen, visuellen, ja beinahe ununterbrochenen Übergang zwischen innen und außen, sodass unsere Wohnbereiche wesentlich größer erscheinen. Im Verlauf der letzten Jahre, hat der Präsident des Unternehmens, Herr Marco Serralunga, einige der berühmtesten Architekten und Designer der Welt, u.a. Zaha Hadid, Philippe Starck und Jean-Marie Massaud, mit der Kreation unglaublich origineller Artikel beauftragt, die sich aufgrund ihrer eleganten und modernen Formen auszeichnen. Die Produkte von Serralunga strahlen diskreten Luxus und ungewohnte Harmonie aus, sodass sie auf intrigante Art und Weise miteinander kombiniert werden können und dabei absolut einmalige Kreationen erschaffen. Ihr prägnant statuarischer Charakter trägt außerdem dazu bei, dem Ambiente, in dem sie eingefügt werden, eine starke Persönlichkeit zu verleihen, wobei das Design sowohl innen als auch außen ein optimales und ansprechendes Ergebnis erzielt. Die von Serralunga realisierten Designer-Produkte setzen die hervorragende Qualität fort, die dem Label "Made in Italy" seit jeher zugeschrieben wird. Gleichzeitig bietet das Unternehmen neue Lebensstile, dank welcher wir uns auf Möbelstücken ausruhen und entspannen können, die unser Leben bereichern.

HISTORY

BACK TO

Serralunga, azienda leader nell'arredamento d'esterni, viene fondata a Biella nel 1825. Il nome è in realtà quello della famiglia che da cinque generazioni è il cuore pulsante, sia creativo che imprenditoriale, dell'azienda. Nata come conceria, passa poi alla lavorazione del cuoio a scopi industriali. La vera rivoluzione arriva in due fasi successive: la prima, intorno al 1950, con la lavorazione della plastica, materia prima che ancora oggi contraddistingue il brand, e poi negli anni '80, con l'importazione dagli Stati Uniti del sistema di stampaggio rotazionale, una tecnologia innovativa che consente di produrre oggetti cavi con dimensioni che arrivano anche a 3.000 litri. Serralunga, per prima in Italia, installa un impianto pilota, iniziando a produrre vasi e rivoluzionando un settore molto tradizionale grazie all'unione vincente di un materiale resistente e leggero con un prodotto di grandi dimensioni e ricerca stilistica. I primi passi nella nuova direzione nascono dal dialogo con Paolo Rizzatto, Alberto Meda e Denis Santachiara, tre progettisti diversi ma accomunati dallo spirito di ricerca e dalla passione per la tecnologia. Nei dieci anni seguenti Marco Serrralunga e Luisa Bocchietto, convinti assertori dell'humus culturale che gravita intorno al Design Made in Italy, si confrontano con una ventina di designer internazionali e danno vita a una collezione spettacolare, sia per forma che per nuove funzioni d'uso, che diventa punto di riferimento e trend setter del settore. Le collezioni che ne derivano sono un insieme di forme e interpretazioni uniche, capaci di trasformare un oggetto puramente funzionale come il vaso in una componente d'arredo straordinaria. Il passo dai vasi ad altri arredi pensati per l'outside è breve: sedute, tavoli e lampade, reinventati per dare ad ambienti esterni, come giardini, terrazze, piscine, ma anche parchi e piazze, la stessa importanza di quelli interni. È questo il percorso che nel 2010, porta Serralunga ad abbracciare la filosofia "Living Different": staccare dalla routine, rompere gli schemi di ogni ambiente tradizionale, esaltando con le sue forme ogni spazio dell'interior design e, allo stesso modo, godersi tutto il bello dell'outside creando una nuova visione dell' Urban Outdoor: un outside che si distingue per uno stile unico, che rende l'esterno confortevole, caldo ed esteticamente prezioso come tradizionalmente lo è stato solo l'interno. Da quasi due secoli ubicata nello stesso luogo, l'azienda produce totalmente in Italia, a Biella, nella via omonima che la città ha voluto dedicare alla famiglia Serralunga, in uno stabilimento di 12.000 mq che impiega 65 dipendenti e ne coinvolge circa il doppio nell'indotto. Qui vengono lavorate oltre 1.200 tonnellate di plastica all'anno, per un totale di circa 200.000 pezzi prodotti.

Serralunga, the leading outdoor furniture company, was founded in Biella in 1825. In reality, Serralunga is the name of the family that has been the creative and entrepreneurial heart of the company for five generations. The company was started as a tannery and then moved into leather processing for industrial purposes. The real revolution took place in two later phases: the first, around 1950, with the processing of plastic, the raw material that is still the brand's features today, and then in the 1980s, with the rotational moulding technique imported from the U.S.A., an innovative technology that allows the production of hollow objects of up to 3,000 litres. Serralunga, the first company in Italy, installed a pilot system and began to produce flowerpots, revolutionizing a very traditional sector with a large and stylish objects production, thanks to the winning combination of hard wearing and light material. The first step in this new direction began with the partnership with Paolo Rizzatto, Alberto Meda and Denis Santachiara, three different designers spurred by with the same spirit of research and passion for technology. During the following decade, Marco Serrralunga and Luisa Bocchietto, passionate advocates of the cultural excitement that developed around the Made in Italy Design, began to work with about 20 international designers in order to produce a collection with spectacular new shapes and uses, which became a reference point and a trend setter in the field. The collections produced were a combination of unique forms and interpretations, capable to transform a purely functional object like a pot into an extraordinarily decorative furnishing item. It was only a short step from pots to other outdoor furniture items like chairs, tables and lamps, reinvented to give outdoor spaces like gardens, terraces and swimming pools, but also parks and squares, the same importance as the indoor has. This was the path that led Serralunga in 2010 to embrace its "Living Different" philosophy: breaking from routine, revolutionizing traditional environments, embellishing every interior design space with its forms and, at the same time, enjoying all the pleasure of outside spaces by creating a new vision of the Urban Outdoors: an outside environment that stands out for its unique style, which makes it comfortable, warm and aesthetically valuable, whereas in the past only indoor spaces were this way. The company has been based in the same place for almost two centuries. Its production is totally concentrated in Biella, Italy, in the street named after the Serralunga family, in a 12,000 m2 plant, employing 65 members of staff and around double in induced activities. The plant processes over 1,200 tons of plastic and produces around 200,000 items a year.

“Living Different” philosophy means breaking from routine, revolutionizing traditional environments, embellishing every interior design space with its forms and, at the same time, enjoying all the pleasure of outside spaces by creating a new vision of the Urban Outdoors.

THE FUTURE

Serralunga, entreprise leader dans l'ameublement pour l'extérieur, est fondée à Biella en 1825. Son nom est en réalité celui de la famille qui, depuis cinq générations, est le cœur battant de l'entreprise aussi bien au niveau créatif qu'entrepreneurial. Ayant vu le jour en tant que tannerie, elle passe ensuite au travail du cuir dans des buts industriels. La véritable révolution arrive en deux phases successives : la première, aux environs de 1950, avec l'usinage du plastique, une matière première qui caractérise encore aujourd'hui la marque, et puis, dans les années 80, avec l'importation des Etats-Unis du système de moulage par rotation, une technologie innovatrice permettant de produire des objets creux avec des dimensions arrivant même jusqu'à 3.000 litres. Pour la première fois en Italie Serralunga installe un équipement pilote, en commençant à produire des vases et en révolutionnant un secteur très traditionnel grâce à l'union victorieuse d'un matériau résistant et léger avec un produit de grandes dimensions résultant de recherche stylistique. Les premiers pas dans la nouvelle direction sont engendrés par la dialogue avec Paolo Rizzatto, Alberto Meda et Denis Santachiara, trois créateurs différents mais liés par l'esprit de recherche et par la passion pour la technologie. Au cours des dix années suivantes Marco Serralunga et Luisa Bocchietto, partisans convaincus de l'humus culturel qui gravite autour du Design Made in Italy, se confrontent avec une vingtaine de designers internationaux et donnent vie à une collection spectaculaire, tant par la forme que par ses nouvelles possibilités d'utilisation, qui devient un point de référence et un "trend setter" du secteur. Les collections qui en dérivent sont un ensemble de formes et d'interprétations uniques, capables de transformer un objet purement fonctionnel comme le vase en un accessoire de décoration extraordinaire. Des vases à d'autres décorations conçues pour l'extérieur, il n'y a qu'un pas : des sièges, des tables et des lampes, réinventés pour donner la même importance que les espaces internes à des espaces externes tels les jardins, les terrasses, les piscines, mais aussi les parcs et les places. C'est le parcours qui amène Serralunga en 2010 à adopter la philosophie « Living Different »: briser la routine, sortir des normes de chaque espace traditionnel, en soulignant chaque espace de l'interior design avec ses formes et, dans le même temps, profiter de toute la beauté de l'outside en créant une nouvelle vision de l'Urban Outdoor: un outside qui se distingue par un style unique, rendant l'extérieur confortable, chaleureux et précieux au niveau esthétique, comme seul l'intérieur l'a été traditionnellement. Située au même endroit depuis presque deux siècles, l'entreprise produit entièrement en Italie, à Biella, dans la rue portant le même nom que la ville a voulu consacrer à la famille Serralunga, dans un établissement de 12.000 m² qui emploie 65 personnes et qui implique environ le double dans les activités. Plus de 1.200 tonnes de plastique sont usinées ici chaque année, pour un total d'environ 200.000 pièces produites.

Die 1825 in Biella gegründete Firma Serralunga ist ein marktführendes Unternehmen im Bereich der Herstellung von Möbeln für den Außenbereich. Die Gründerfamilie, die ihr den Namen gibt, stellt seit fünf Generationen in Sachen Kreativität und Management das pulsierende Herz des Unternehmens dar. Das Unternehmen war einst eine Gerberei und ging dann nach und nach auf die Verarbeitung von Leder für Industrienanwendungen über. Die eigentliche Revolutionierung des Unternehmens erfolgte aber in zwei darauffolgenden Phasen: Die erste Phase trat um das Jahr 1950 ein, als man mit der Verarbeitung von Kunststoff begann - der Rohstoff, der heute noch die Produktion des Unternehmens prägt. Die zweite Phase erfolgte in den 80er Jahren, als aus den Vereinigten Staaten das Rotationspressverfahren importiert wurde, eine damals innovative Technologie, anhand welcher man hohle Gegenstände mit einem Fassungsvermögen von bis zu 3.000 Litern erzeugen konnte. Serralunga installierte als erstes italienisches Unternehmen eine Pilotanlage und begann mit der Produktion von Vasen und Töpfen. Die gelungene Synthese zwischen einem leichten, widerstandsfähigen Material und einem Produkt großer Ausmaße sowie der stilistischen Forschung hat diese sehr traditionsgebundene Branche grundlegend revolutioniert. Die ersten Schritte in diese neue Richtung wurden dank der Zusammenarbeit mit Paolo Rizzatto, Alberto Meda und Denis Santachiara unternommen: Drei grundverschiedene Projektentwerfer, die jedoch vom Forschungsdrang und der Leidenschaft für zukunftsweisende Technologien verbunden werden. Während der zehn darauffolgenden Jahre arbeiteten Marco Serralunga und Luisa Bocchietto - überzeugte Unterstützer des Made in Italy - intensiv mit etwa zwanzig international bekannten Designern zusammen, die eine spektakuläre Kollektion entwarfen. Diese Kollektion zeichnet sich heute noch nicht nur durch ihre Formen aus, sondern auch durch ihren neuen Bestimmungszweck, sodass sie gleichermaßen zum Bezugspunkt und zum Trendsetter der Branche geworden sind. Die daraus hervorgehenden Kollektionen sind ein Zusammenspiel von einzigartigen Formen und Interpretationen, die in der Lage sind einen rein funktionellen Gegenstand, wie einen Topf, in einen überwältigenden Einrichtungsgegenstand zu verwandeln. Der Übergang von der Herstellung von Töpfen auf Einrichtungsgegenstände für den Außenbereich fiel nicht allzu schwer: Neu durchgedachte Sitzgelegenheiten, Tische und Lampen sollten Außenbereichen wie z. B. Gärten, Terrassen, Schwimmbädern, aber auch Parkanlagen und sogar Ortsplätzen denselben Stellenwert beimessen, wie internen Wohnräumen. Dies ist der Grundgedanke, welcher Serralunga im Jahre 2010 dazu gebracht hat sich folgende Unternehmensphilosophie anzueignen: "Living Different": Routine ablegen, Schemen aller traditionellen Ambiente brechen, indem die Formen des Interior Design in jedem Raum in den Vordergrund gestellt werden und durch die Kreation einer neuen Vision des Urban Design das Schöne am Outside genießen. Ein Außenbereich, der sich durch einen unverkennbaren Stil auszeichnet und ihn genauso komfortabel, angenehm und ästhetisch ansprechend macht, wie bislang nur Innenbereiche zu sein vermochten. Das Unternehmen, das seit beinahe zwei Jahrhunderten denselben Firmensitz hat, stellt seine gesamte Produktion in Italien her, genauer gesagt in der gleichnamigen Straße, welche die Stadt Biella als Anerkennung nach dem Namen der Familie Serralunga benannt hat. Das Firmengelände ist 12.000 m² groß und zählt rund 65 interne Mitarbeiter und eine doppelt so große Anzahl an Mitarbeitern in den Zulieferbetrieben. Hier werden jährlich über 1.200 Tonnen Kunststoff verarbeitet, d. h. eine Gesamtanzahl von etwa 200.000 hergestellten Artikeln.

DESIGNERS



Eero Aarnio



Aquilalberg



Ron Arad



Shin Azumi



Bazzicalupo – Mangiarotti



Claudio Bellini



Ricardo Bello Dias



Sebastian Bergne



Luisa Bocchietto



Bortolani – Righi



Michel Boucquillon



Calvi – Brambilla



Aldo Cibic



Carlo Colombo



Michele De Lucchi



Rodolfo Dordoni



Marta Daza Fernandez



Naoto Fukasawa



Joan Gaspar



Giovanni Jacobone



Zaha Hadid



Arik Levy

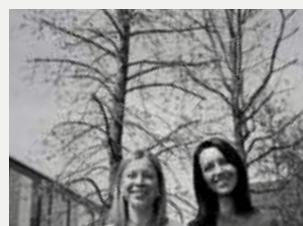

Lineeverdi



Ross Lovegrove



Vico Magistretti



Raffaella Mangiarotti



Jean-Marie Massaud



Alberto Meda



Lina Obregon



Philippe Nigro



Christophe Pillet



Patrizia Pozzi



Andrée e Olivia Putman



Karim Rashid



Paolo Rizzato



Marc Sadler



Denis Santachiara



Ettore Sottsass



Garth Roberts



Massimo Roj



Philippe Starck



Brian Steendyk



Patricia Urquiola



Ionna Vautrin



ZPZ Partners

INDEX

POTS

P. 10-93

CASSERO	32
CONE	36
CUBOTTI LIGHT 3	92
CUP	40
EUFRONIO	44
FAITUTTOTU	66
FLOW	10
GREEN PILLS	70
HIC!	52
HOLLY ALL	20
JUNE	74
KABIN	88
LLUNA	82
MING	46
MISSED TREE	14
NEW POT	58
NEW WAVE	62
PRIMAVERA	54
SANTAVASE	86
SEVRES	78
THE VASES	50
TOP POT	24
VAS FAMILY & BIG BO	26

FURNITURE

P. 94-183

BANQUÉTÉ	102
BARCELONETA	122
BAY	128
CANISSE	136
GIULIETTA	180
HOUR	140
JUJU	156
KENTIA	160
KUBRICK	132
LAZY	164
LOOP	168
LOU LOU	106

LOUNGETTE	126
METEOR	172
ONE	146
PILE UP	94
PINE BEACH	150
REGISTA T17	98
ROMEO	176
RUSSELL	116
SOLEA	112
TIME OUT	118

COMPLEMENTS & GIFTS

P. 184-203

BINGO	184	97
DOGGY	198	
MING-ETTO	48	
NEW WAVE MINI	64	
GIANO	186	
PALOMA	190	
PULCINO	194	
VAS-ETTO	30	

LIGHTS

P. 202-225

BABÀ	202	107	127
BONHEUR	204		
CRYSTAL MOON	208	29	143
HONEY	218		
LADY JANE	212		
LADY MARY	212	169	
LAMPA-DARIA	210		
MISS JANE	216		
SCARLETT	222		

APPENDIX

SERRALUNGA, A PASSION FOR INNOVATION.	3
HISTORY	4
DESIGNERS	6
TECHNICAL DETAILS	226
COLOURS & FABRICS	230

POTS FLOW

DESIGNER
ZAHA HADID



FLOW L
L 146 X H 200



FLOW M
L 117 X H 120





Flow — Coating in pure metal



Serpentine Gallery — Londra



Flow — Metallic lacquered finishing

POTS MISSED TREE

DESIGNER
JEAN-MARIE MASSAUD

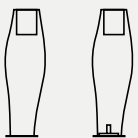

MISSED TREE I / LIGHT
Ø 50 X H 159

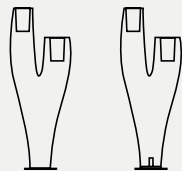

MISSED TREE II / LIGHT
Ø 75 X H 200



MISSED TREE III
47 X 41 X H 56



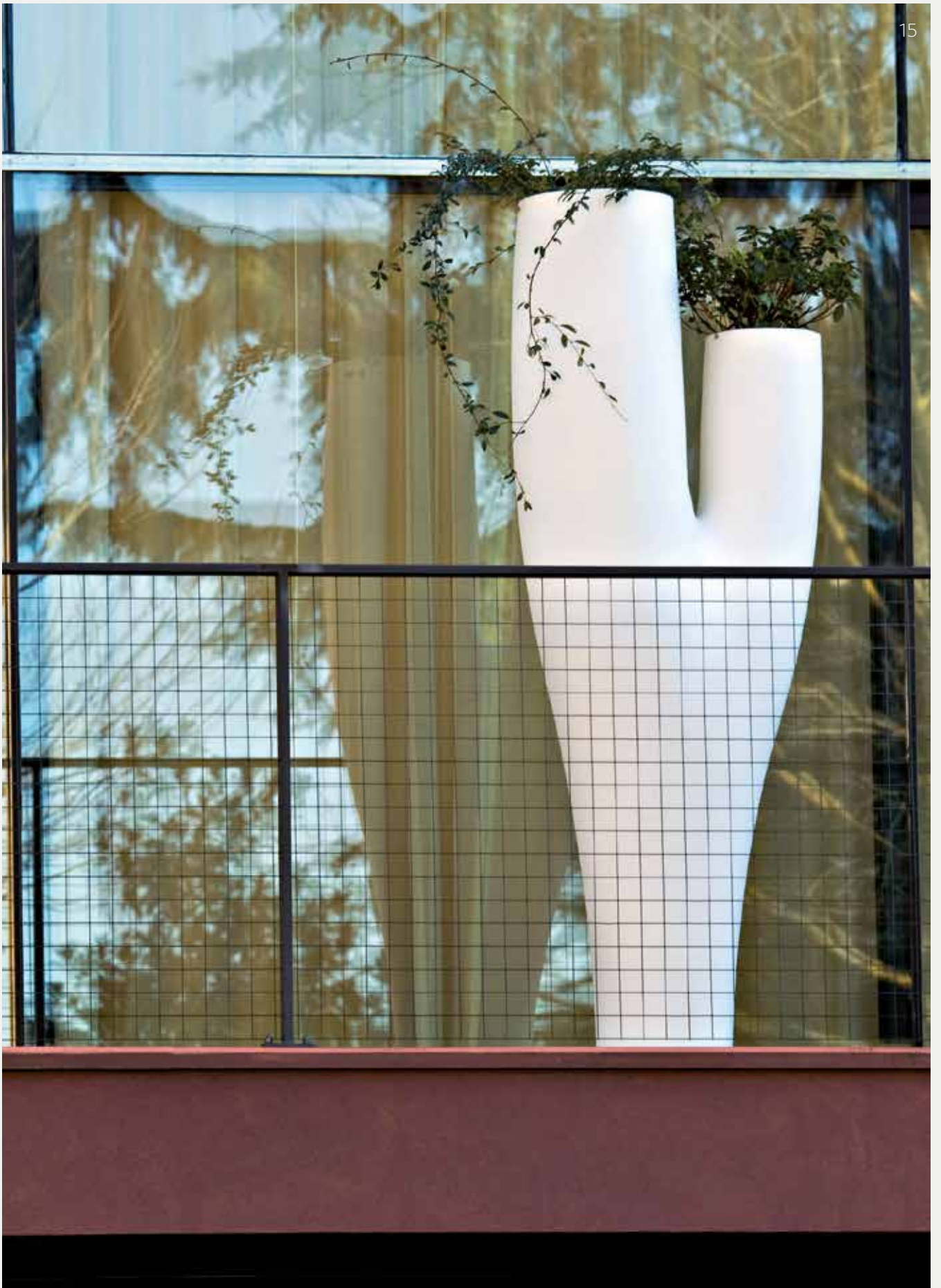

Missed Tree II



Missed Tree I, II, III



Missed Tree II with light



Missed Tree I, II



Missed Tree I, II, coating in pure metal

POTS HOLLY ALL

DESIGNERS
PHILIPPE STARCK
EUGENI QUITLLET

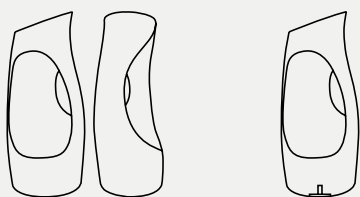

HOLLY ALL / LIGHT
Ø 92 X H 200







Holly All — Metallic lacquered finishing



Holly All — Lacquered finishing

POTS TOP POT



DESIGNER
RON ARAD

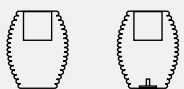

TOP POT / LIGHT
Ø 65 X H 100





Top Pot

POTS VAS FAMILY & BIG BO

DESIGNER
LUISA BOCCHIETTO



VAS-ONE / LIGHT
Ø 130 X H 120



VAS-TWO / LIGHT
Ø 160 X H 150



VAS-THREE / LIGHT
Ø 60 X H 55

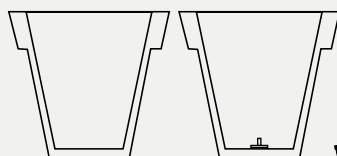

BIG BO / LIGHT
Ø 200 X H 180



VAS-ETTO
Ø 13 X H 12



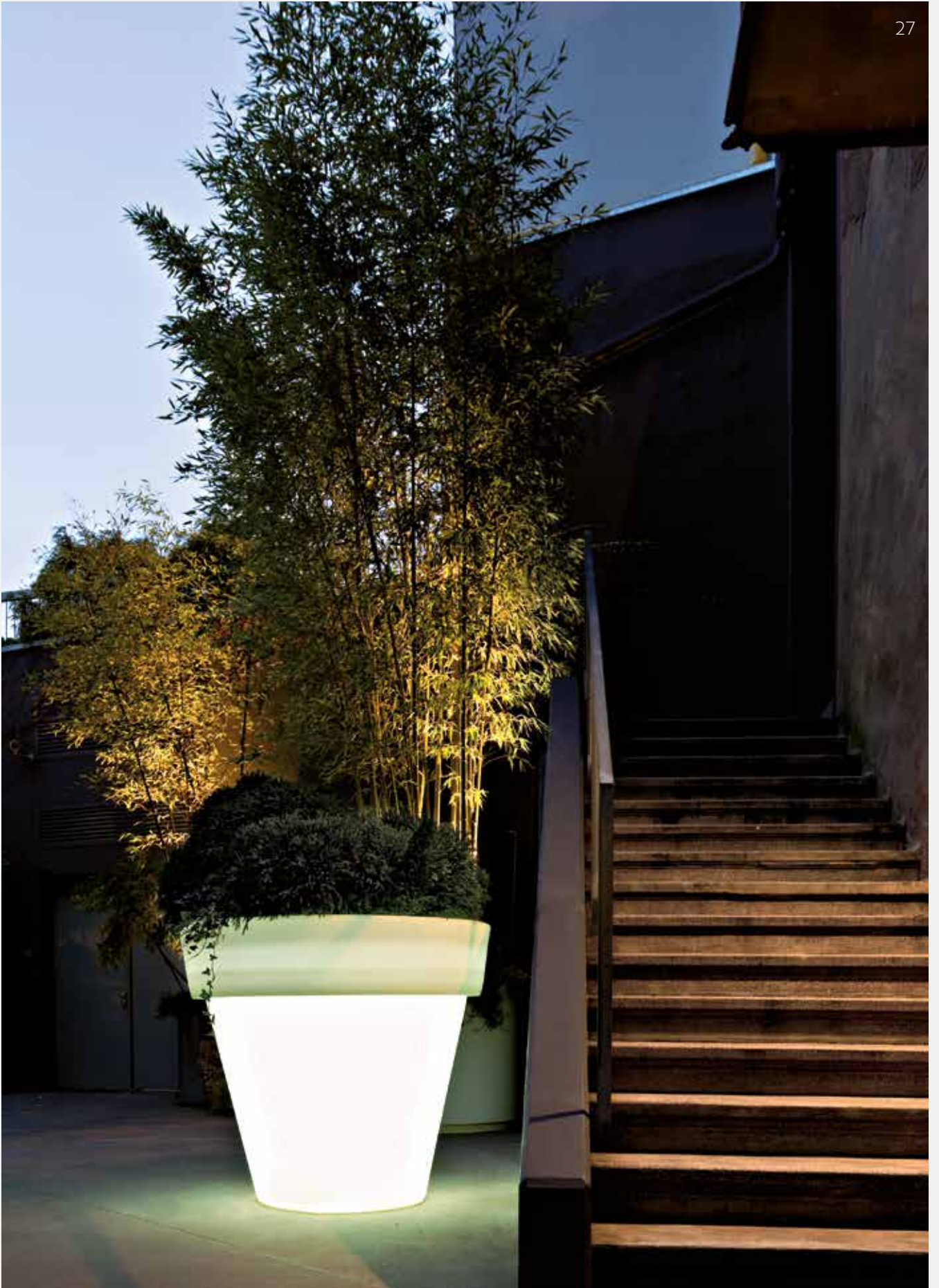

Vas-One with Light



*Vas-One and Vas-Two
Hour Collection sofa*

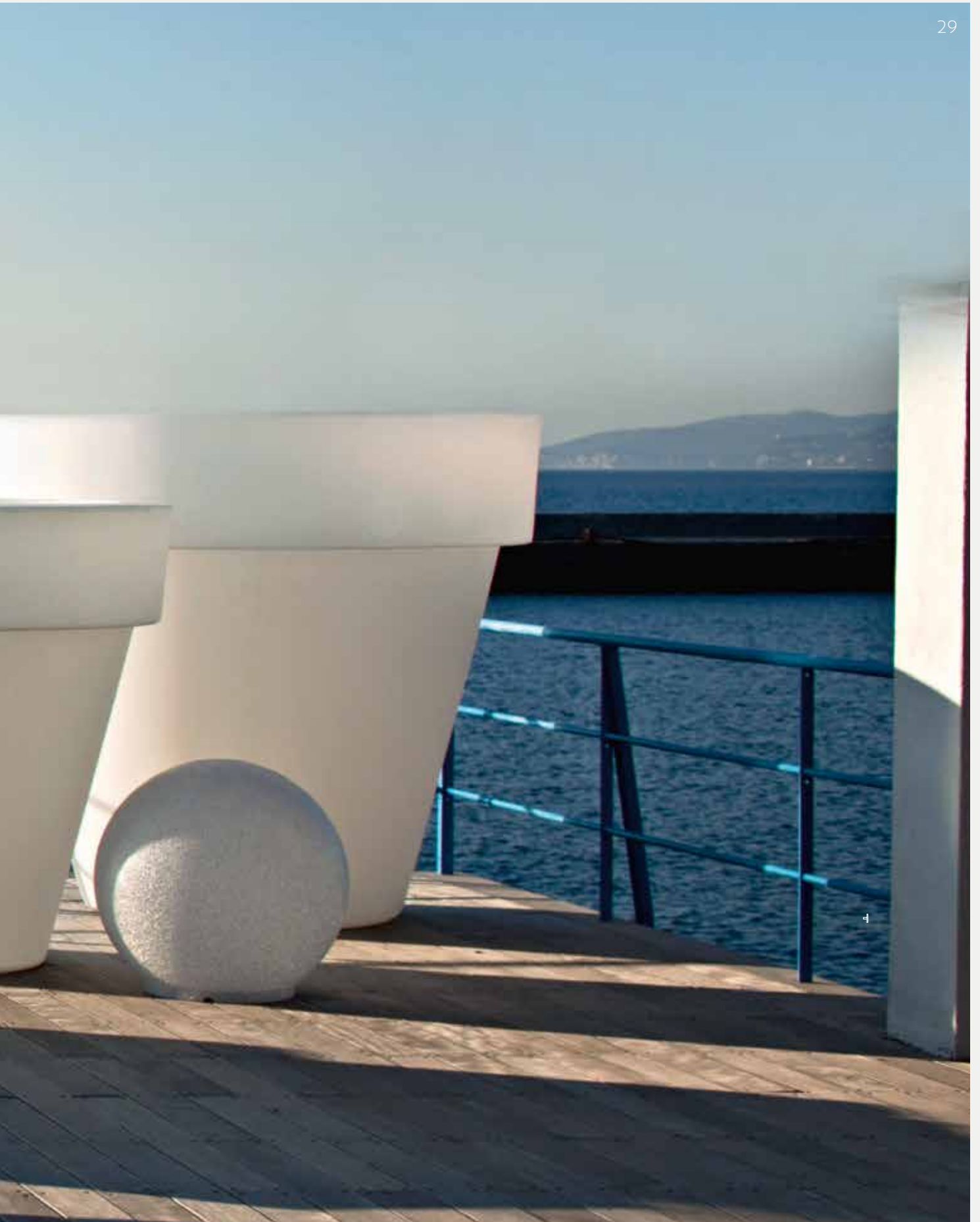

*Crystal Moon Lamp
Toy table*



Vas-One, Vas-two, Vas-etto



*Vas-One e Vas-Two
Crystal Moon Lamp
Giulietta*

POTS CASSERO

DESIGNER
PATRICIA URQUIOLA



CASSERO 60
Ø 60 X H 70



CASSERO LONG
L 100 X P/D 48 X H 55





Cassero 60



Cassero 60 e Long



Cassero 60 e Long

POTS CONE



DESIGNER
NAOTO FUKASAWA

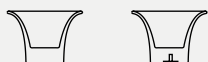

CONE BIG / LIGHT
Ø 130 X H 90





Cone



Cone with Light



Cone — Lacquered finishing

POTS CUP



DESIGNER
NAOTO FUKASAWA



CUP S
Ø 47 X H 25



CUP M
Ø 48 X H 40



CUP L
Ø 70 X H 58





Cup M — Lacquered finishing



Cup S — Lacquered finishing



Cup M — Lacquered finishing

POTS EUFRONIO

DESIGNER
PAOLO RIZZATTO

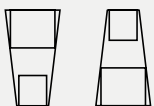

EUFRONIO
Ø 74 - Ø 50 X H 126





POTS MING

DESIGNER
RODOLFO DORDONI



MING EXTRAHIGH / LIGHT
Ø 66 X H 100



MING HIGH / LIGHT
Ø 130 X H 120



MING EXTRALARGE
Ø 113 X H 75



MING LARGE
Ø 80 X H 50



MING SMALL
Ø 56,5 X H 33



MING-ETTO
Ø 14,5 X H 10





Ming High with light



Ming Extralarge, Large, Small, Ming-Etto



Ming High, Large, Small — Metallic lacquered finishing

POTS THE VASES

DESIGNER
RON ARAD



THE VASES
L80 X P/D 65.5 X H 110





The Vases

POTS HIC!

DESIGNER
MARC SADLER



HIC!
Ø 56 X H 240





Hic! — Carbon fiber

POTS PRIMAVERA

DESIGNER
EERO AARNIO



PRIMAVERA / LIGHT
Ø 130 X H 120





*Primavera vases
Belle Étoile bench*



Primavera



Primavera

POTS NEW POT

DESIGNER
PAOLO RIZZATTO



NEW POT HIGH
Ø 35 X H 90



NEW POT MAXI
Ø 44 X H 120



NEW POT COLLECTION
Ø 12 X H 12 / Ø 23 X H 23 / Ø 28 X H 28 / Ø 34 X H 34 / Ø 40 X H 40
Ø 50 X H 50 / 60 X H 60 / Ø 70 X H 70 / Ø 90 X H 90





New Pot collection — Lacquered finishing



New Pot collection — Lacquered finishing



New Pot collection — Lacquered finishing

POTS

NEW WAVE

DESIGNER
ROSS LOVEGROVE



NEW WAVE / LIGHT
Ø 77 X H 92



NEW WAVE MINI
Ø 15 X H 18





New Wave — Lacquered finishing



New Wave, New Wave Mini — Lacquered finishing



New Wave with light

POTS FAITUTTOTU

DESIGNER
ETTORE SOTTASS



MODULE 52 + 35
Ø 52 X H 65



MODULE 52
Ø 52 X H 34



MODULE 35
Ø 35 X H 17



CILINDRIC JOINT
Ø 16 X H 14,5





Faituttotu







Faituttotu

POTS GREEN PILLS

DESIGNER
ZPZ PARTNERS

GREEN PILLS 54
L 54 X P/D 33 X H 27

GREEN PILLS 43
L 43 X P/D 26 X H 21

GREEN PILLS SYSTEM
2x43 + 2x54 H 300







Green Pills



Green Pills

POTS JUNE



DESIGNER
CHRISTOPHE PILLET



JUNE / LIGHT / SPOTLIGHT
Ø 60 X H 120





June with Spotlight



June



June — Lacquered finishing

POTS SEVRES

DESIGNER
RODOLFO DORDONI



SEVRES HIGH
Ø 42,5 X H 100



SEVRES MEDIUM
Ø 48,5 X H 55





Sevres Medium — Laquered finishing



Sevres High — Laquered finishing



Sevres Medium — Laquered finishing

POTS LLUNA

DESIGNER
JOAN GASPAR



LLUNA 110 / LIGHT
L 110 X P/D 40 X H 65



LLUNA NOVA / LIGHT
L 40 X P/D 40 X H 120



LLUNA PLENA / LIGHT
L 40 X P/D 40 X H 66





Lluna 110 with light



Lluna 110 with light



Lluna Plena, Lluna Nova

POTS SANTAVASE

DESIGNER
DENIS SANTACHIARA



SANTAVASE
Ø 40 X H 85





Santavase

POTS KABIN

DESIGNER
LUISA BOCCHIETTO



KABIN HIGH
Ø 35 X H 70



KABIN MAXI
Ø 44 X H 100





Kabin Maxi — Lacquered finishing



Kabin High, Kabin Maxi lacquered finishing



Kabin High lacquered finishing

POTS CUBOTTI LIGHT 3

DESIGNER
NAT WAVE



CUBOTTI LIGHT 3
L 37 X P/D 37 X H 30



CUBOTTI LIGHT 3
L 38 X P/D 38 X H 89,5



CUBOTTI LIGHT 3
L 50 X P/D 50 X H 44



CUBOTTI LIGHT 3
L 72 X P/D 72 X H 61,5





Cubotti light 3 – Lacquered finishing

FURNITURE PILE UP

DESIGNER
MICHEL BOUCQUILLON



PILE UP ROUND
Ø 70 X H 71



PILE UP SQUARE
70 X 70 H 71



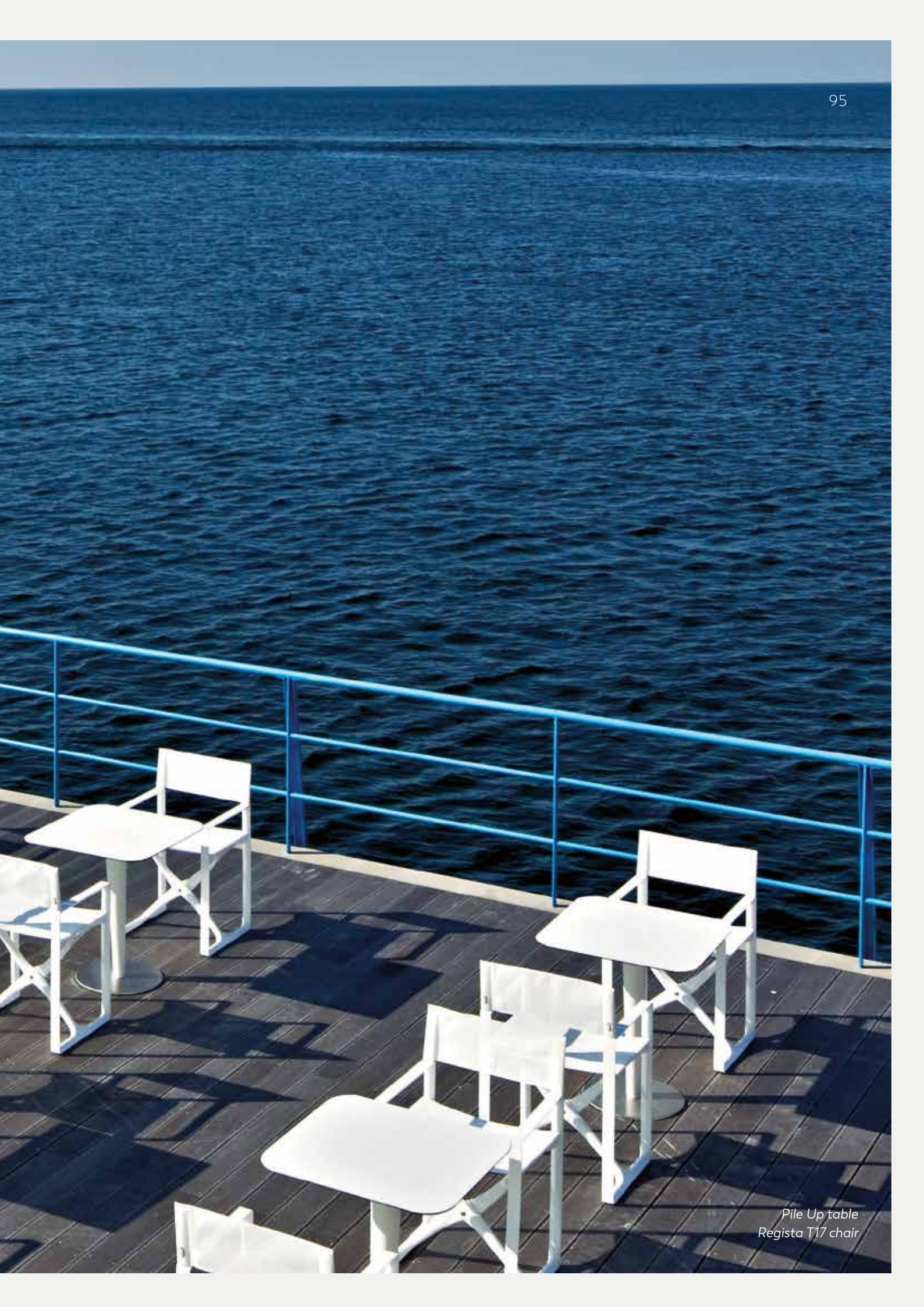

*Pile Up table
Regista T17 chair*



Pile Up tables



*Pile Up table
Lluna 110
Bingo*



FURNITURE REGISTA T17

DESIGNER
MICHEL BOUCQUILLON



REGISTA T17
L 52 X P/D 44 X H 83



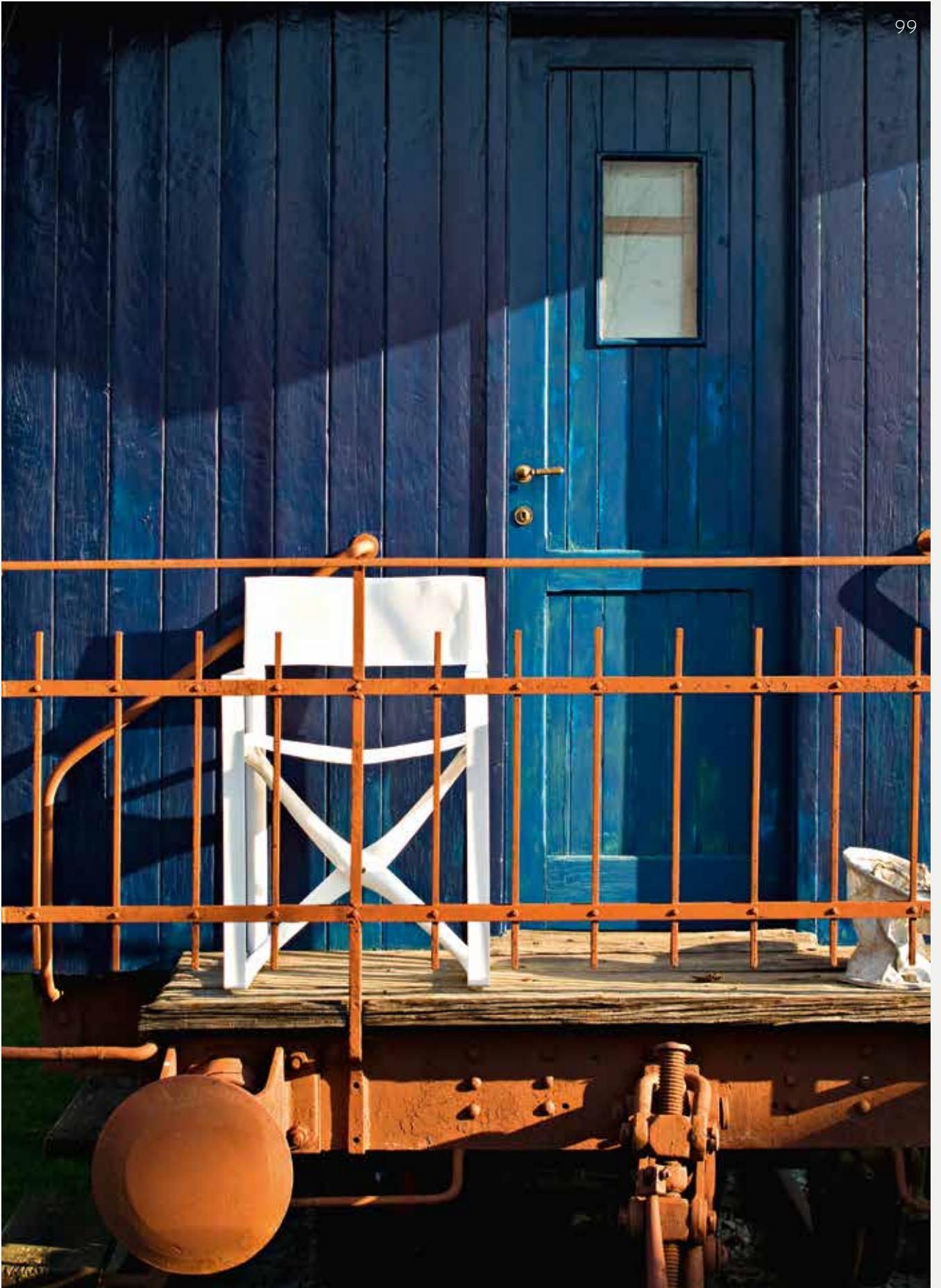

Regista T17



Regista T17



Regista T17

FURNITURE BANQUÉTÉ

DESIGNER
CALVI & BRAMBILLA

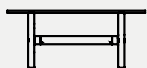

BANQUÉTÉ WOODEN TOP
L 180/240 X P/D 104 X H 75

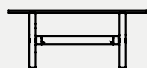

BANQUÉTÉ STEEL TOP
L 180/240 X P/D 104 X H 75





Banquéte table



Banqu  t   table



*Banquété table
Regista T17*

FURNITURE

LOU LOU

DESIGNER
RAFFAELLA MANGIAROTTI



LOULOU SLIM 70 / 105 / LIGHT
Ø 60 / 70 / 80 X H 71 / 105
60 X 60 / 70 X 70 / 80 X 80 X H 71 / 105



LOULOU 34 / 40 / 50 / LIGHT
Ø 60 / 70 / 80 X H 35 / 41 / 51
60 X 60 / 70 X 70 / 80 X 80 X H 35 / 41 / 51



LOU LOU 70 LARGE
Ø 140 X H 72
Ø BASE 70





Loulou 34 / 40 / 50 — Marble finishing



Loulou 34 / 40 / 50 — Matt metallic lacquered finishing



*Lou Lou 70 large table
Regista T17 Chair*



Lou Lou 70 Slim table e Lou Lou 105 Slim table with light



Lou Lou 34/50 — Matt metallic lacquered finishing

FURNITURE SOLEA

DESIGNER
GIACOBONE & ROJ



SOLEA ARMCHAIR
L 65 X P/D 55 X H 73



SOLEA CHAIR
L 62 X P/D 55 X H 73



SOLEA ROUND TABLE
Ø 80 X H 73



SOLEA SQUARE TABLE
L 80 X P/D 80 X H 73





Solea armchair and table



Solea square table



Solea chair and table

FURNITURE RUSSELL

DESIGNER
VICO MAGISTRETTI



RUSSELL
L 66 X P/D 59 X H 81





*Russell chair
Giulietta bench*

*LouLou 70 slim table
Bonheur hanging lamp*

FURNITURE TIME OUT

DESIGNER
RODOLFO DORDONI



TIME OUT ARMCHAIR
L 73 X P/D 73 X H 78



TIME OUT RECLINABLE CHAISE LONGUE
L 66 X P/D 171 X H 74



TIME OUT STOOL
L 65 X P/D 54 X H 36



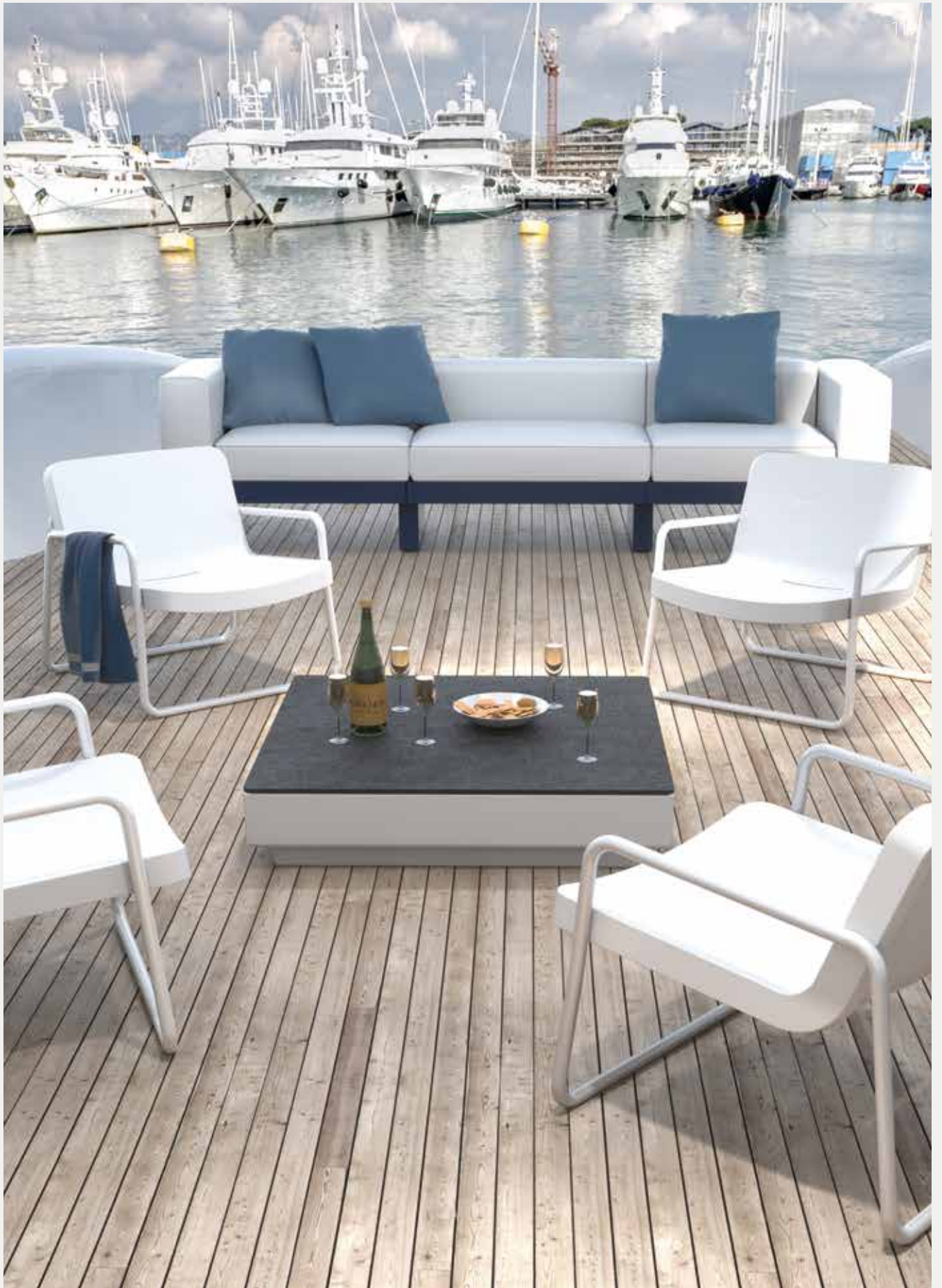

*Time Out armchair
Hour sofa
One table*



Time Out armchair and stool



*Time Out reclining chaise longue
Top Pot*

FURNITURE BARCELONETA

DESIGNER
RAFFAELLA MANGIAROTTI



BARCELONETA
L 77 X P/D 77.5 X H 77

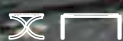

BARCELONINA
L 77 X P/D 45 X H 37





Barceloneta armchair and Barceloniña stool



Barceloneta armchair and Barceloniña stool



Barceloneta armchair

FURNITURE LOUNGETTE

DESIGNER
RAFFAELLA MANGIAROTTI



LOUNGETTE ARMCHAIR
L 81 X P/D 75 X H 75



LOUNGETTE STOOL
L 78 X P/D 45 X H 42





*Loungette armchair indoor wooden frame and stool
Loulou 40 table
Baba floor lamp*

FURNITURE BAY

DESIGNER
RAFFAELLA MANGIAROTTI



BAY
L 65 X P/D 65 X H 70





Bay Lounge Chair — Metallic lacquered finish



Bay Lounge Chair — Metallic lacquered finish



Bay Lounge Chair — Metallic lacquered finish

FURNITURE KUBRICK

DESIGNER
MARC SADLER



KUBRICK
L 64 X P/D 62 X H 72





Kubrick armchair



*Kubrick armchair — Lacquered finishing
Palenquera table*



*Kubrick armchair
Pelenquera table*

FURNITURE CANISSE

DESIGNER
PHILIPPE NIGRO



CANISSE ARMCHAIR
L 98 X P/D 88 X H 80



CANISSE SOFA
L 173 X P/D 88 X H 80





*Canisse sofa and armchair
LouLou 40 table*



Canisse sofa



*Canisse sofa and armchair
Ming High and Extra*



FURNITURE HOUR

DESIGNER
CLAUDIO BELLINI



HOUR
MODULE WITH ARM AND BACK REST
L 95 X P/D 75 X H 72



HOUR
POUF
L 95 X P/D 95 X H 41



HOUR
TAVOLO / TABLE
L 95 X P/D 95 X H 21







Hour — 1 x module with arm and back rest

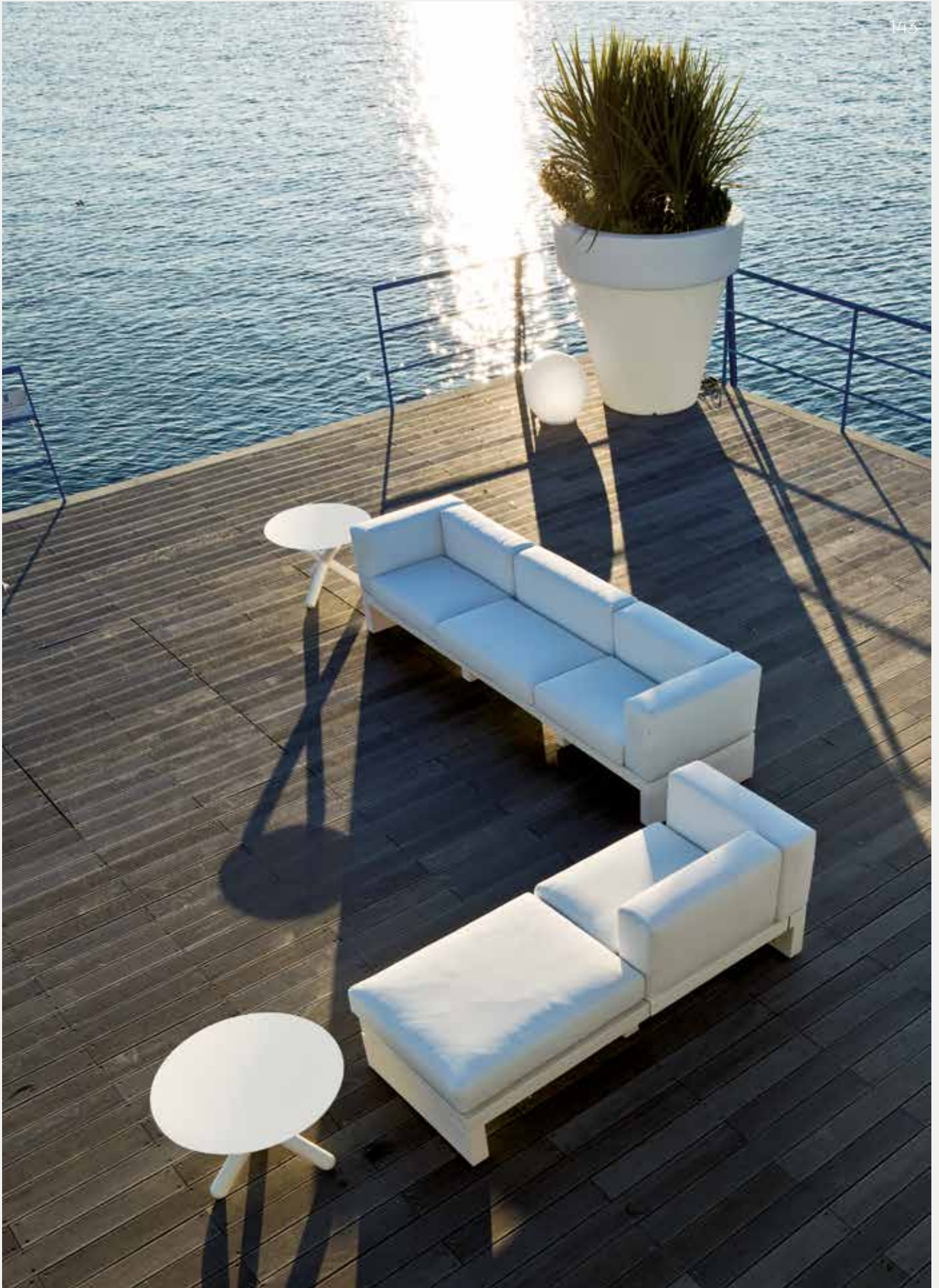

Vas-One
Crystal Moon Lamp
Toy table

Hour — 3 seats module with arm and back rest
Hour — 2 seats module with arm and back rest



Hour — 2 seats module with back rest



*Hour — 3 seats module with arm and back rest
Hour — Table*



FURNITURE ONE

DESIGNER
MARC SADLER



ONE POUFF
L 96 X P/D 96 X H 41



ONE TABLE
L 94 X P/D 94 X H 21



ONE MODULE
L 120 X P/D 96 X H 70

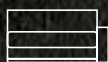

ONE MODULE
1 ARM REST
L 135 X P/D 96 X H 70

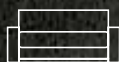

ONE MODULE
2 ARM REST
L 150 X P/D 96 X H 70

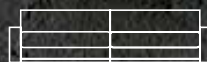

ONE
2 x MODULE 1 ARM REST
L 270 X P/D 96 X H 70







One sofa and pouff — 2 seats module with arm and back rests

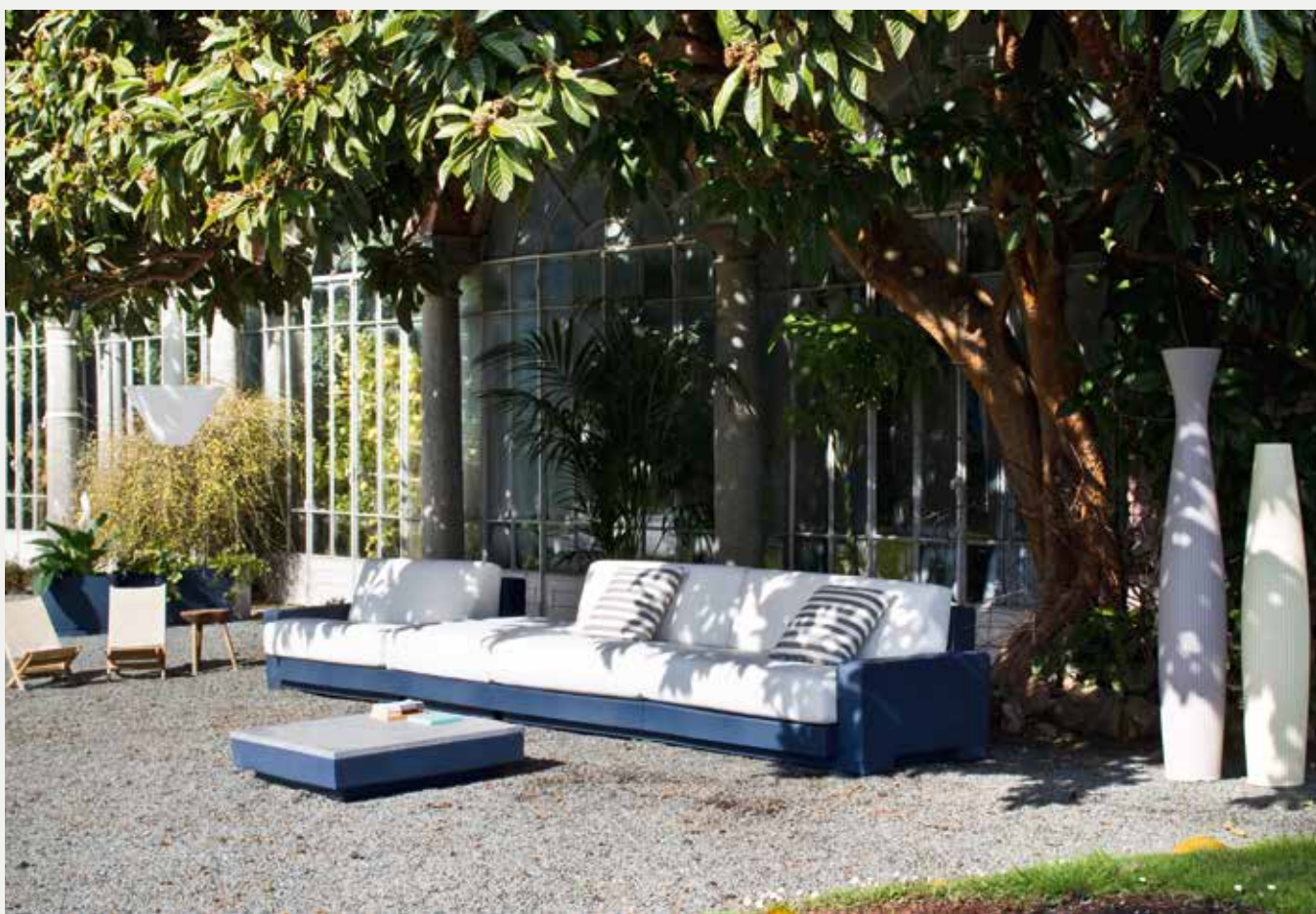

*One sofa and table
Scarlet 140/180
Bonheur hanging lamp*

FURNITURE PINE BEACH

DESIGNER
CHRISTOPHE PILLET



PINE BEACH ARMCHAIR
L 70 X P/D 66 X H 76



PINE BEACH SOFA
L 180 X P/D 81 X H 76





*Pine Beach sofa and armchair with light
Juju table with light
Grand Mary pot with light*



*Pine Beach sofa and armchair
Juju table
Doggy*



*Pine Beach armchair
Juju table*





Pine Beach armchair and sofa

FURNITURE JUJU

DESIGNER
GARTH ROBERTS



JUJU / LIGHT
Ø 52 X H 50



Juju table marble finishing



Juju table
Pine Beach armchair



Juju table



*Juju table
Pine Beach armchair*

FURNITURE KENTIA

DESIGNER
LINEEVERDI



KENTIA WALL
L 90 X P/D 5 X H 150





Kentia wall



Kentia wall



Kentia wall

FURNITURE LAZY

DESIGNER
MICHEL BOUCQUILLON



LAZY SUNBED
L 72 X P/D 172-215 X H MAX 103
H SEDUTA / SEAT 28



LAZY 1 SEAT DECK-CHAIR
L 52 X P/D 95-140 X H MAX 120
H SEDUTA / SEAT 19 - 28



LAZY 2 SEAT DECK-CHAIR
L 102 X P/D 95-140 X H MAX 120
H SEDUTA / SEAT 19 - 28





Lazy deck-chair



Lazy 2 seats deck-chair



Lazy sunbed

FURNITURE LOOP

DESIGNER
CHRISTOPHE PILLET

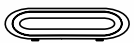

LOOP / LIGHT
L 180 X P/D 50 X H 40





*Loop bench — Lacquering finishing
Lampa Daria light*

*June pot
Lady Mary lamp*



Loop bench with light



Loop bench with light

FURNITURE METEOR

DESIGNER
ARIK LEVY



METEOR S / LIGHT
L 57 X P/D 50 X H 30



METEOR M / LIGHT
87 X P/D 52 X H 32



METEOR L / LIGHT
L 117 X P/D 69 X H 34





Meteor table/bench — S, M and L sizes



Meteor table / bench with light



Meteor table/bench with light

FURNITURE ROMEO

DESIGNER
PAOLO RIZZATTO



ROMEO
L 115 X P/D 61 X H 96





Romeo bench — Lacquered finishing



Romeo bench — Lacquered finishing



Romeo bench — Lacquered finishing

FURNITURE GIULIETTA



DESIGNER
PAOLO RIZZATTO



GIULIETTA
L 185 X P/D 67 X H 100



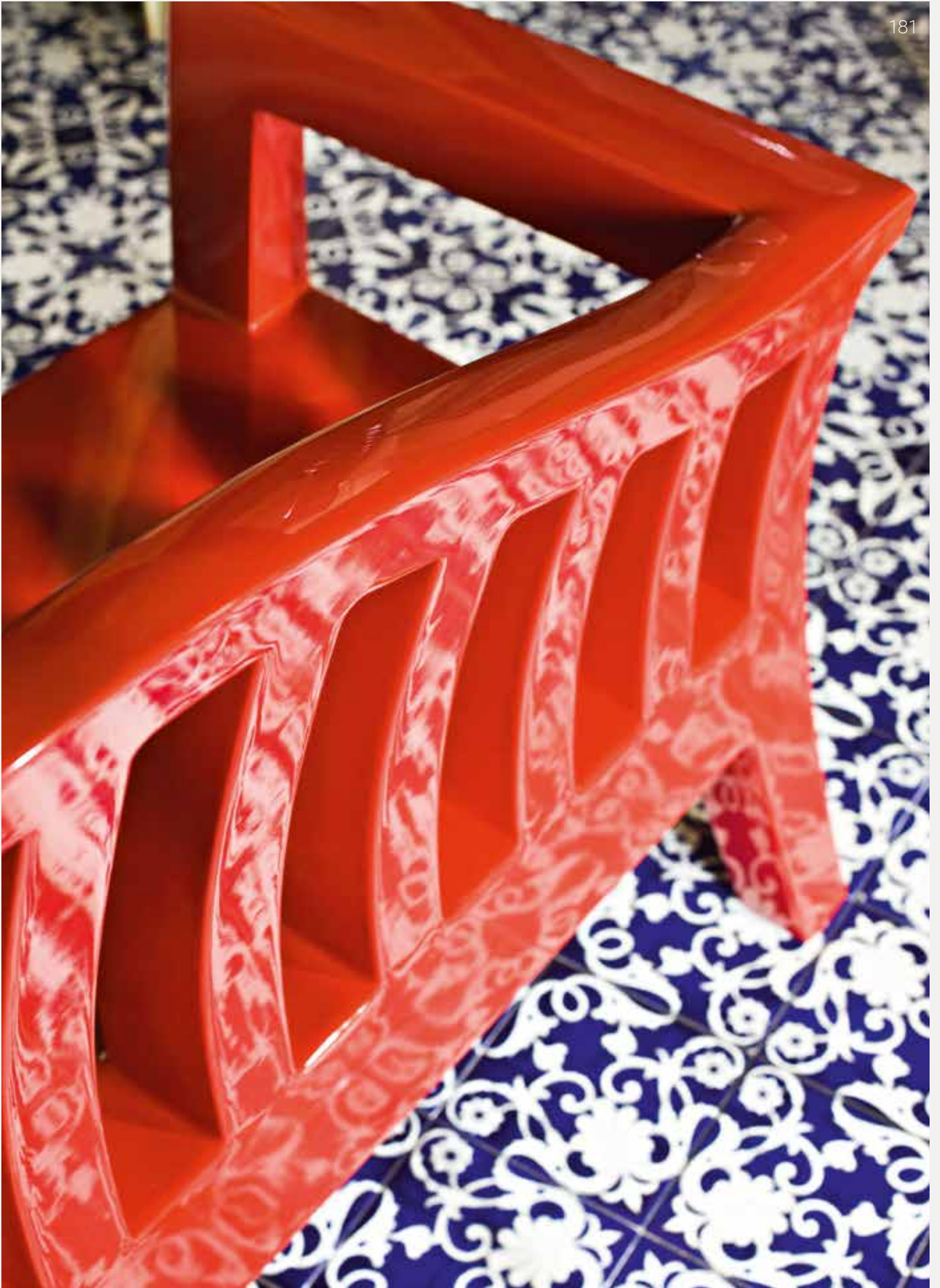

Giulietta bench — Lacquered finishing



Giulietta bench — Lacquered finishing



Giulietta bench — Lacquered finishing

COMPLEMENTS & GIFTS BINGO

DESIGNER
MARTA DAZA FERNANDEZ

0123456789

BINGO
L 23/35 X P/D 8 X H 45



18



COMPLEMENTS & GIFTS GIANO

DESIGNER
LAURA BOCCHIETTO



GIANO
L 32 X H 60





Giano — Umbrella stand



Giano — Umbrella stand



Giano — Umbrella stand

COMPLEMENTS & GIFTS PALOMA

DESIGNER
EERO AARNIO



PALOMA / LIGHT
L 130 X P/D 38 X H 53



Paloma seat/bench with light



Paloma seat/bench — Metallic lacquered finishing



Paloma and Pulcino

COMPLEMENTS & GIFTS PULCINO

DESIGNER
EERO AARNIO

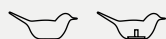

PULCINO / LIGHT
L 80 X P/D 27 H 39



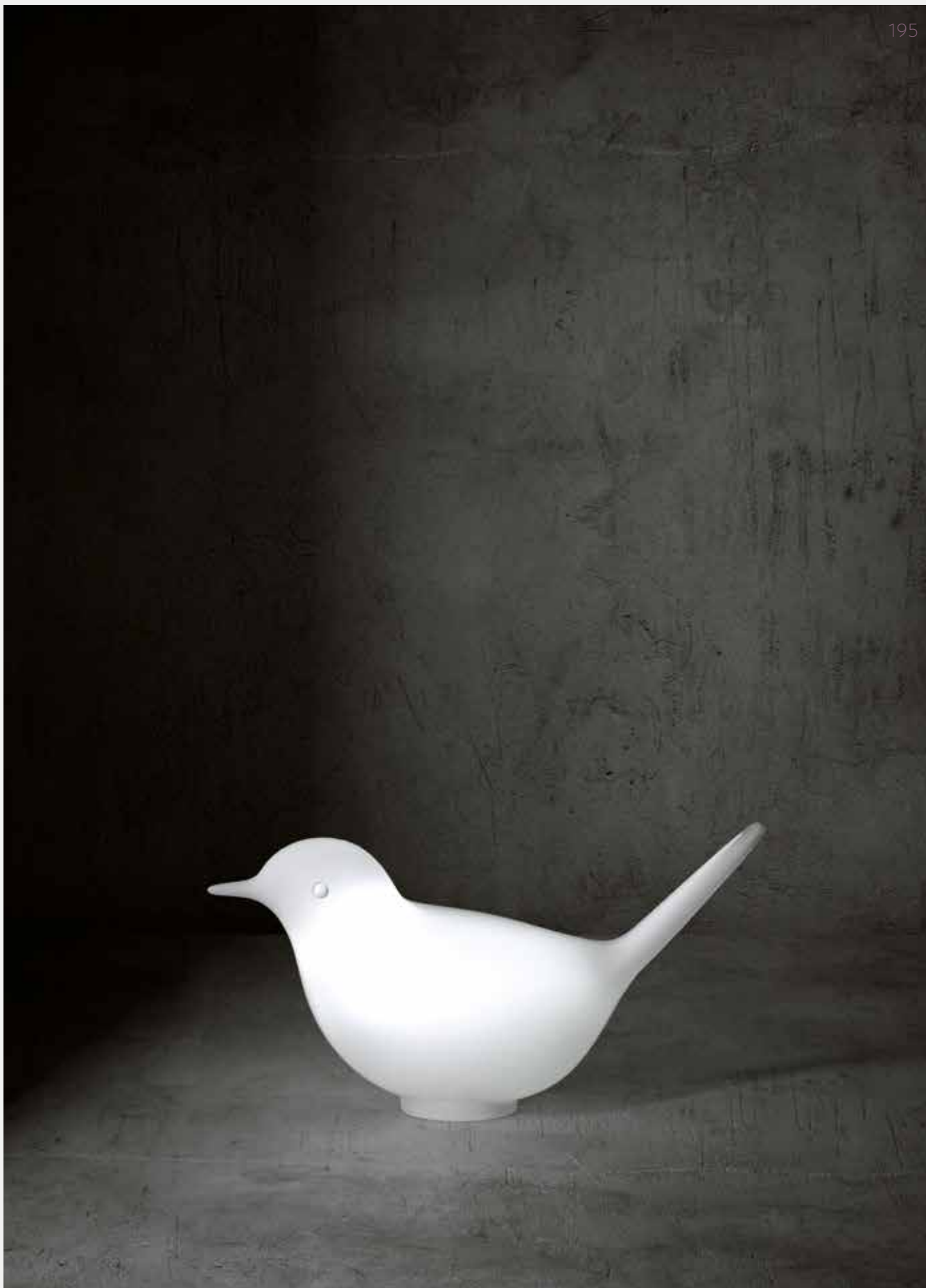

Pulcino — with RGB light



Pulcino — Lacquered finishing
Paloma seat/bench



Pulcino — with and without RGB light

COMPLEMENTS & GIFTS DOGGY

DESIGNER
EERO AARNIO



DOGGY
L 60 X P/D 27 X H 55





Doggy bench corten finishing





*Doggy bench — pure metal coating
Pulcino — pure metal coating*

LIGHTS BABÀ

DESIGNER
SERRALUNGA



BABÀ FLOOR LAMP
Ø 52 X H 138



BABÀ HANGING LAMP
Ø 52 X H 35



BABÀ PETITE FLOOR LAMP
Ø 62 X H 52





Babà collection

LIGHTS BONHEUR

DESIGNER
MICHELE DE LUCCHI



BONHEUR FLOOR LAMP
Ø 56 X H 180



BONHEUR HANGING LAMP
Ø 56 X H 80
CABLE MAX LENGHT 170CM





Bonheur floor lamp



Bonheur hangingt lamp



Bonheur hanging lamp

LIGHTS

CRYSTAL MOON

DESIGNER
SERRALUNGA



CRYSTAL MOON - S
Ø 40 X H 38



CRYSTAL MOON - M
Ø 55 X H 53



CRYSTAL MOON - L
Ø 75 X H 73





Crystal Moon

LIGHTS

LAMPA-DARIA

DESIGNER
LUISA BOCCHIETTO



LAMPA-DARIA
Ø 110 X H 51





Lampa-Daria hanging lamp

LIGHTS

LADY MARY

LADY JANE

DESIGNER
MARC SADLER



LADY MARY
Ø 70 X H 208



LADY JANE
Ø 55 X H 208





Lady Mary and Lady Jane — Matt metallic lacquered finishing



Lady Jane — Lacquered finishing



Lady Jane — Lacquered finishing

LIGHTS MISS JANE

DESIGNER
MARC SADLER



MISS JANE
Ø 40 X H 150





Miss Jane — Matt metallic lacquered finishing

LIGHTS HONEY

DESIGNER
RAFFAELLA MANGIAROTTI
MARCO RAVINA



HONEY LANTERN
Ø 24 X H 31





Honey lantern



*Honey lantern
Pulcino with light*



Honey lantern

LIGHTS SCARLETT



DESIGNER
CRISTOPHE PILLET



SCARLETT 140 / NO LIGHT
Ø 28 X H 140



SCARLETT 180 / NO LIGHT
Ø 28 X H 180



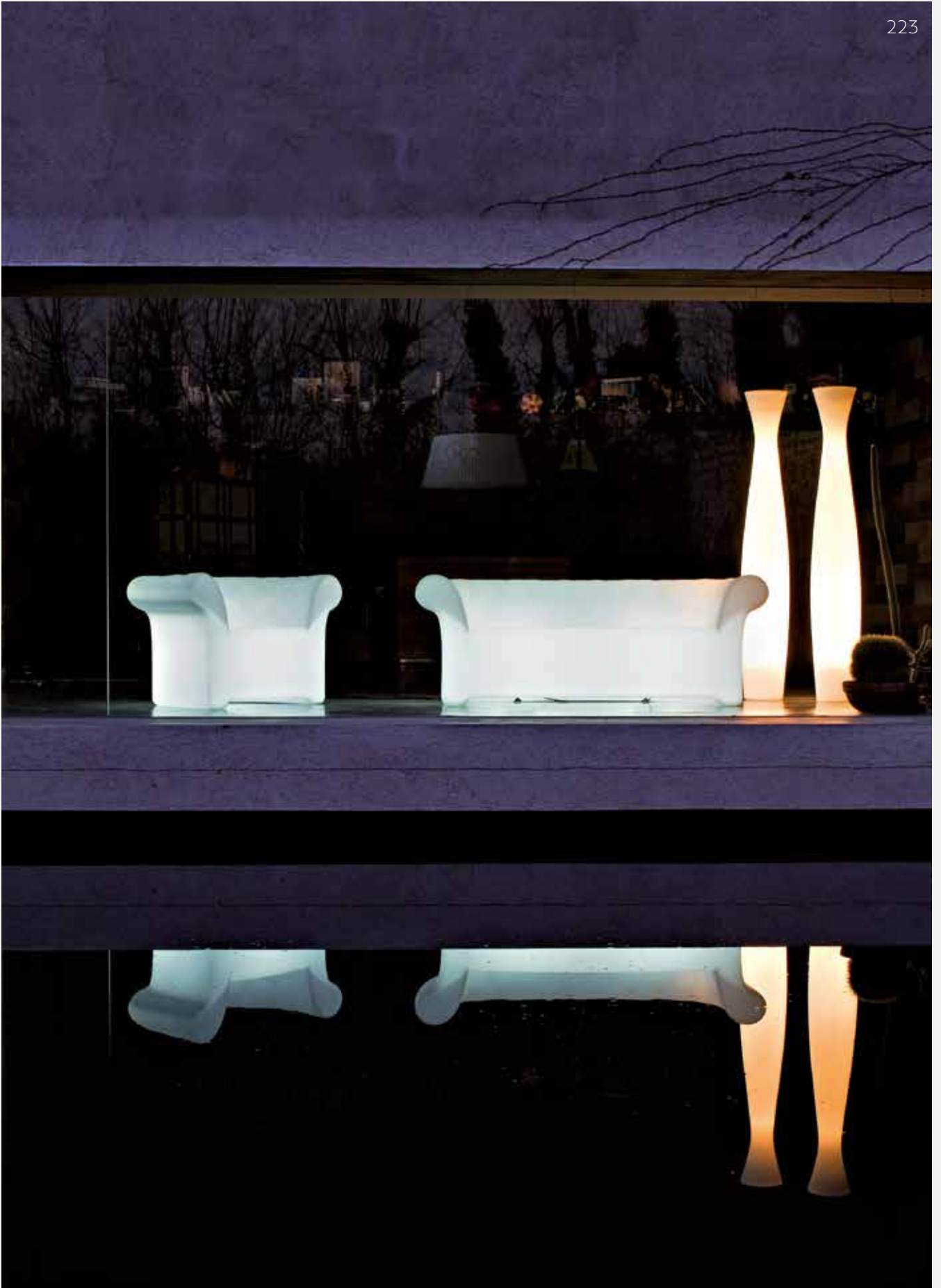

*Scarlett Lamp 180
Sirchester Sofa and Armchair with light*



*Scarlett without Light 140/180
Canisse Sofa and Armchair
Loulou 50 table*



Scarlett Lamp 140/180

TECHNICAL DETAILS



SISTEMA DI DRENAGGIO WATER DRAINAGE SYSTEM

Tutti i vasi illuminati sono dotati di sistema di drenaggio per l'acqua. Rimuovere il tappo all'interno del vaso per far defluire l'acqua.

All illuminated pots are equipped with a water drainage system. Remove the inner stopper to drain water.

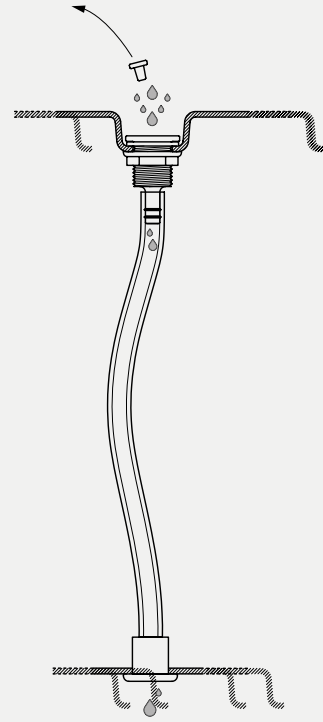

FISSAGGIO A TERRA GROUND FIXING

I prodotti possono essere fissati a terra tramite piastre in acciaio inox AISI 316.

I tasselli per l'ancoraggio non sono inclusi nel kit, ma devono essere acquistati in base al tipo di pavimentazione su cui si desidera fissare il prodotto.

Si consigliano 3 piastre per i vasi tondi e 2/4 piastre per i vasi quadrati e rettangolari.

Products can be fixed to the ground with AISI 316 stainless steel plates. Rawplugs are not included in this kit, they must be bought according to the ground where you want to fix the product.

We suggest 3 plates for round pots and 2/4 plates for square and rectangular pots.

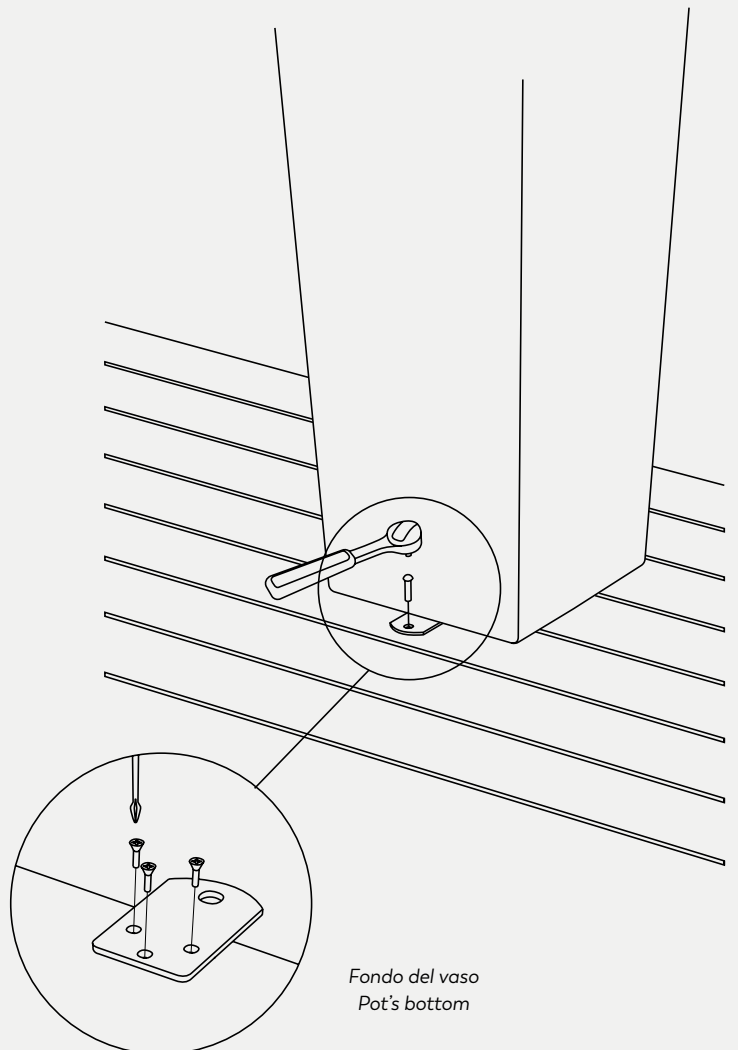

Fondo del vaso
Pot's bottom

IMPIANTI LUCE LIGHTING SYSTEMS

Impianto luce a risparmio energetico

Energy saving bulb 20W (E27).
220/240V (110/120V) - 50/60Hz - Class II.
Cavo nero 3m.
Lampadina fornita non assemblata.
Protezione IP67.

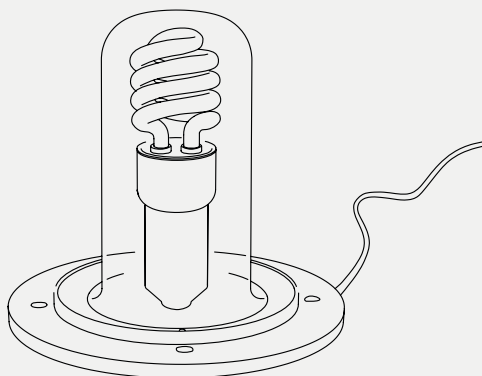

Energy saving lighting system

Energy saving bulb 20W (E27).
220/240V (110/120V) - 50/60Hz - Class II.
3 m black wire.
Bulb included but not assembled.
IP 67 protection.

▽ ⓧ Ⓜ CE Ⓛ IP67 CB

Impianto luce led RGB

9W.
100/240V - 50/60Hz - Class II.
Cavo nero 3m.
Lampada fornita non assemblata.
Pilotabile con telecomando a RF
per sequenza colori.
Protezione IP67.

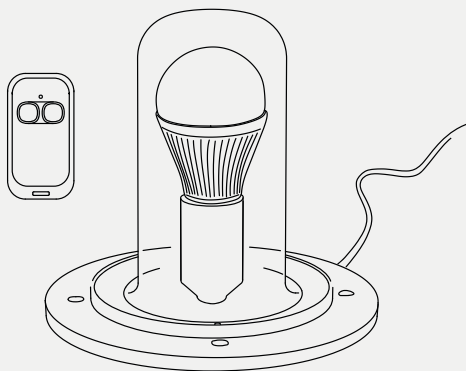

RGB led lighting system

9W.
100/240V - 50/60Hz - Class II.
3m black wire.
Led bulb included but not assembled.
Operated by RF remote control
for colours sequence.
IP67 protection.

▽ ⓧ Ⓜ CE Ⓛ IP67 CB

Protezione IP67

Protezione totale alla penetrazione di corpi solidi e polveri. Protezione contro l'immersione momentanea in acqua per 30 minuti ad 1 metro di profondità.

IP67 Protection

Total protection against solid corps and powders penetration. Protection against water immersion for 30 minutes at 1 meter deep.

Impianto luce led RGB wireless Bluetooth (Energy A class).

1,2W RGB LED – batteria al litio 3,7V – 1750mAh.
 Autonomia: fino a 20 ore.
 Tempo di ricarica 6 ore.
 Stazione di ricarica: AC input 110/240V.
 50/60Hz, output DC 5V. **Per uso interno.**
 Pilotabile con app da cellulare per sequenza colori,
 oppure con pulsanti sul fondo dell'impianto.
 Protezione impianto luce IP68.

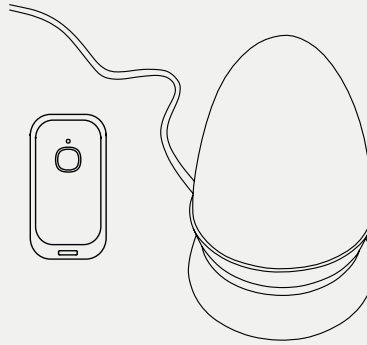

CE FC IP68

Wireless RGB Bluetooth led lighting system (Energy A Class).

1,2 W RGB LED – lithium battery 3.7V – 1750mAh.
 Operating range: up to 20 hours.
 Recharging time: 6 hours.
 Charging station: AC input 100/240 V.
 50/60 Hz, output DC 5 V. **For indoor usage.**
 Operated by mobile app for colours sequence or
 buttons on the bottom of the lighting system.”
 IP68 lighting system protection.

Impianto luce LED RGBW 2W wireless

Batteria al litio 3.7V – 1200 mAh.
 Autonomia: fino a 32 ore.
 Tempo ricarica: 4-5 ore.
 Stazione di ricarica ad induzione:
 input AC 100-240 V - 50/60 Hz,
 Output DC 7,5 V - PER USO INTERNO.
 Pilotabile con pulsanti sul fondo dell'impianto.
 Protezione IP68.

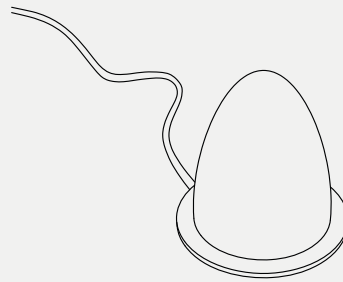

CE IP68

Light System LED RGBW 2W wireless

Litium battery 3.7V.
 1200 mah.
 Autonomy: up to 32 hours.
 Charging time: 4-5 hours.
 Induction charging station:
 AC input 100-240 v - 50/60 hz,
 DC output 7,5 v - for indoor use.
 Controllable with buttons on the bottom
 of the plant.
 IP68 Protection

Protezione IP68

Protezione totale alla penetrazione di corpi solidi e polveri. Protezione contro l'immersione permanente in acqua ad 1 metro di profondità.

P68 Protection

Total protection against solid corps and powders penetration. Protection against permanent water immersion at 1 meter deep.

COLOURS & FABRICS



STANDARD COLOURS

231



Bianco / WH

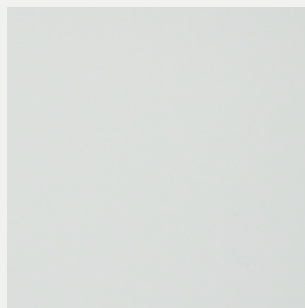

Neutro Luce / NT

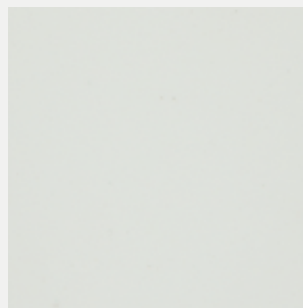

Neve di San Candido / IWH

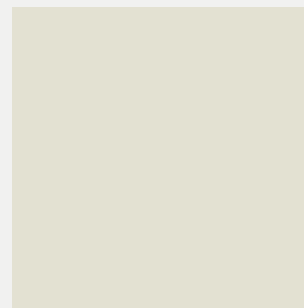

Gesso di Bologna / WH5



More di Rovo / BK



Pietra delle Dolomiti / GG



Salvia di Sardegna / SAV

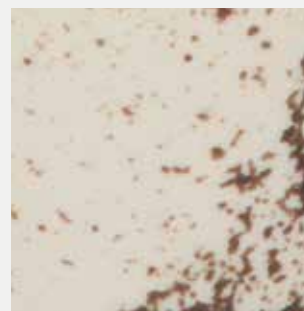

*Coffee Delavè / ICA **



Pietra di Matera / IV AV



Tortora di Torino / TO

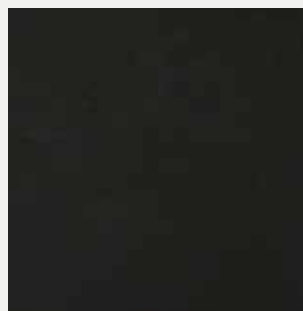

Antracite di Sardegna / ANT



Corten / COR

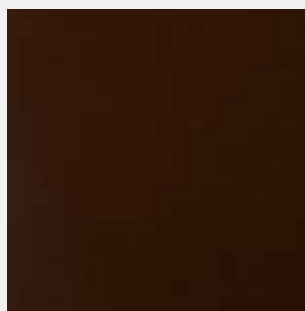

Terracotta scura / TC4



Terracotta classica / TC2

** Irregular spatula finish not uniform
* Finitura spatolata non uniforme*

STANDARD COLOURS



Impruneta classica / IMP

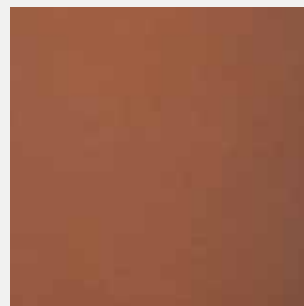

Terracotta Toscana / TC



Apple Green / AG



Olive di Cerignola / VOC



Origano di Sardegna / VMA



Acqua della Maddalena / AQM



Azzurro di Provenza / AZP

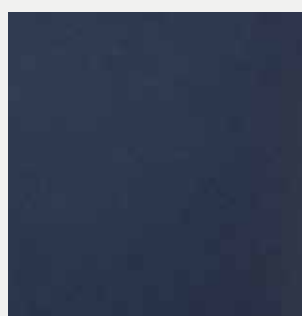

Blu di Portofino / BLP



Verde Pavone / WP



Fucsia / FU



Orange / OR



Rosso / RO

** Irregular spatula finish not uniform
* Finitura spatolata non uniforme*

MATT METALLIC LACQUERED



Azzurro / LAM



Blu / LBM

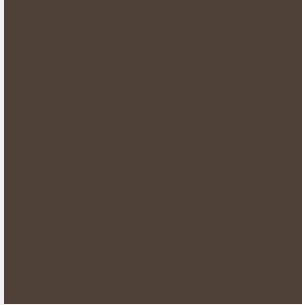

Grigio scuro / LGM



Titanio / LTM



Ottone / LOM



Sabbia / LSM



Rame / LCM

GLOSSY METALLIC LACQUERED COLOURS



Oro LGO



Argento / LCH

GLOSSY LACQUERED COLOURS



Bianco / LWH

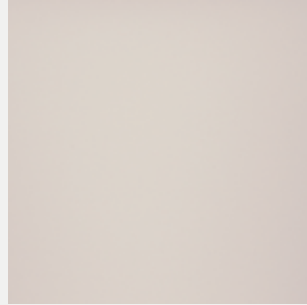

Milk / LMI



Zinco / LZN



Antracite / LAN



Nero / LBK



Grigio 150 / LGS

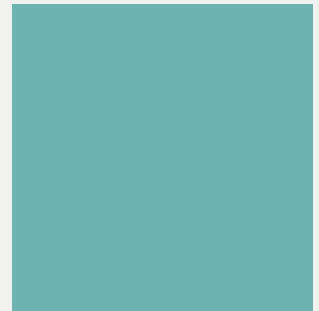

Azzurro Audrey / LAT



Arancio / LOR



Rosso / LRO



Full Moon / DOVE



Full Moon / ABSINTHE



Full Moon / GUNSMOKE



100% Polyolefinic

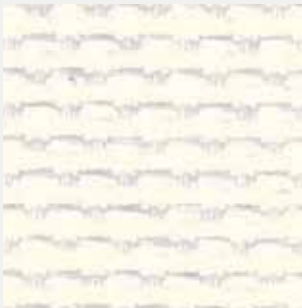

Half Moon / BIANCO



Half Moon / GHIACCIO

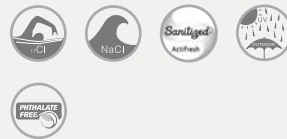

100% Polypropylene



Sea / WHITE



Sea / RUSTY

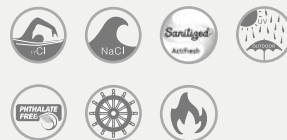

89% PVC
11% PA

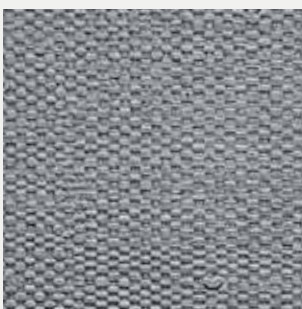

Yuta / LIGHT GREY



Yuta / CHESTNUT



85% PVC
15% PL

100% PVC coated polyester
mod. Lazy / mod. La Regista



Batyline / BIANCO



Batyline / NERO

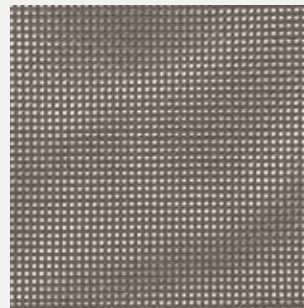

Batyline / ORIGANO

LEGEND / LEGENDA



Chlorine resistant /
Resistente al cloro



Phthalate free /
Senza ftalati



Sea salt resistant /
Resistente al sale



IMO MED mod. B + D



Fungi and bacterial resistant /
Resistenza a funghi e batteri



Fire retardant /
Resistente al fuoco



Outdoor use suitable /
Adatto ad uso esterno



Medical use suitable /
Adatto ad uso medico

BARCELONETA

237

SEAT /
SEDUTA

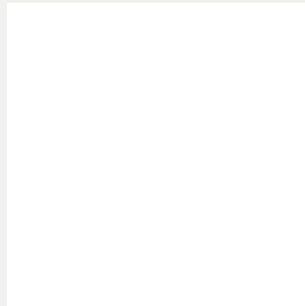

Bianco

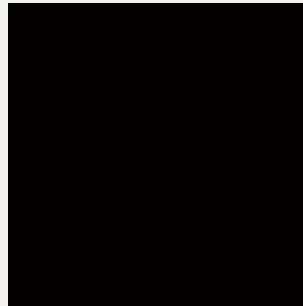

Nero



Tortora

FRAME /
STRUTTURA

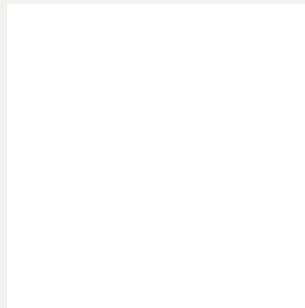

Bianco

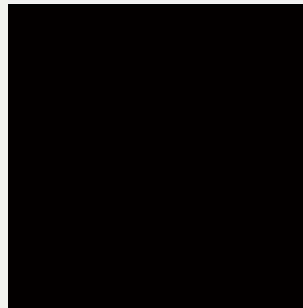

Nero

SOFA
COVERS /
COPRI
DIVANO

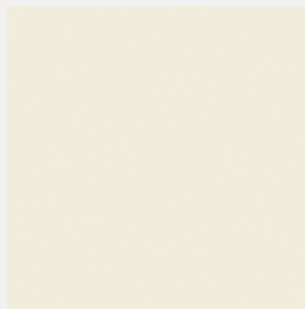

Beige

Poiana
20% polyuretane
80% polyester

*CUSHION PADDING: PPT fiber,
crosslinked polyurethane, mesh fabric.
Fire-retardant version 1IM class upon request.*

NOTE: ground fixing available on request.

SERRALUNGA

www.serralunga.com