



OPEN

OUTDOOR COLLECTION
2017_2020

Varaschin
OUTDOOR THERAPY

OUTDOOR THERAPY

L'esterno e la natura:
un caleidoscopio di colori che generano
un dialogo ininterrotto tra design e personalità.
Le mani vogliono accarezzare, gli occhi vedere e cogliere
quei riferimenti del mondo outdoor in cui ci riconosciamo.

Ma non solo.

La collezione outdoor seduce senza invadere,
in un continuo equilibrio tra creatività,
colore e ricerca della rarità.

La suggestione di un intreccio, la texture di una tela,
lo spessore di un legno, l'incisione di una pietra
si fondono in una luce calante o nel mare di mezzogiorno.

La vasta gamma di offerta si colloca in una direzione
contemporanea ricca di funzionalità silenziose,
ma attente alle novità e a tutto ciò che si definisce design
come laboratorio creativo.

Per noi e per la nostra cultura.

Una filosofia che ci tiene in contatto con il mondo.

E che rende l'esterno più bello.

*Outdoor furniture and nature:
a kaleidoscope of colours that provoke a dialogue
between design and personality.
Hands want to touch and eyes want to see
and capture the elements of the outdoor world we recognize.*

But not only.

*Our outdoor collection seduces without intruding,
in a continuous balancing act of creativity, colour and search for rarity.*

*The evocation of a weave, the texture of a fabric,
the thickness of wood and an engraving on a stone
come together in the dusk or the mid-day sea.*

*Our wide range of products goes in a contemporary direction
and is rich in discreet functionality, but at the same time
pays attention to novelty and everything that can be defined
as design and used as a creative workshop.*

*This is a philosophy that keeps us
and our culture constantly in touch with the world.
And enhances the attraction of the outdoors.*

WEAVING ADDICTED

Così come amiamo gli intrecci, rappresentiamo il concetto di trama per le infinite combinazioni di finiture e le numerose provenienze dei materiali naturali e tecnologici. Una sottile linea di confine mostra come il linguaggio multimaterico possa rappresentare la nuova cosmesi di un design colto e cosmopolita. Un vero laboratorio di stile nasce, immagina e si evolve. Così ogni prodotto celebra la fine di un processo e l'inizio di uno nuovo.

*Just as we love weavings,
we employ the concept of weave
for the infinite combinations of finishes
and numerous origins of natural and technological materials.
A subtle boundary shows how multi-textured language
can represent the new cosmetic effect of cultured,
cosmopolitan design.
A true style laboratory is established that applies imagination
and evolves.
In this way each product celebrates
the end of a process and the beginning of a new one.*



INDEX

ALGARVE_008

ALTEA_050

ARENA_028

CORA_076

LOTUS_090

METRÒ_110

TONKINO_042

OMBRELLONI_SUN UMBRELLAS

AMALFI_118

CAPRI_116

ISCHIA_120

POSITANO_122

COPACABANA_124

GAZEBO

HAWAII_126

ALGARVE_

DESIGN BY R&D VARASCHIN

Collezione in fibra sintetica
intrecciata a mano con intelaiatura
in alluminio verniciato.

*Collection with varnished aluminium
frame and hand woven man-made
fibre.*

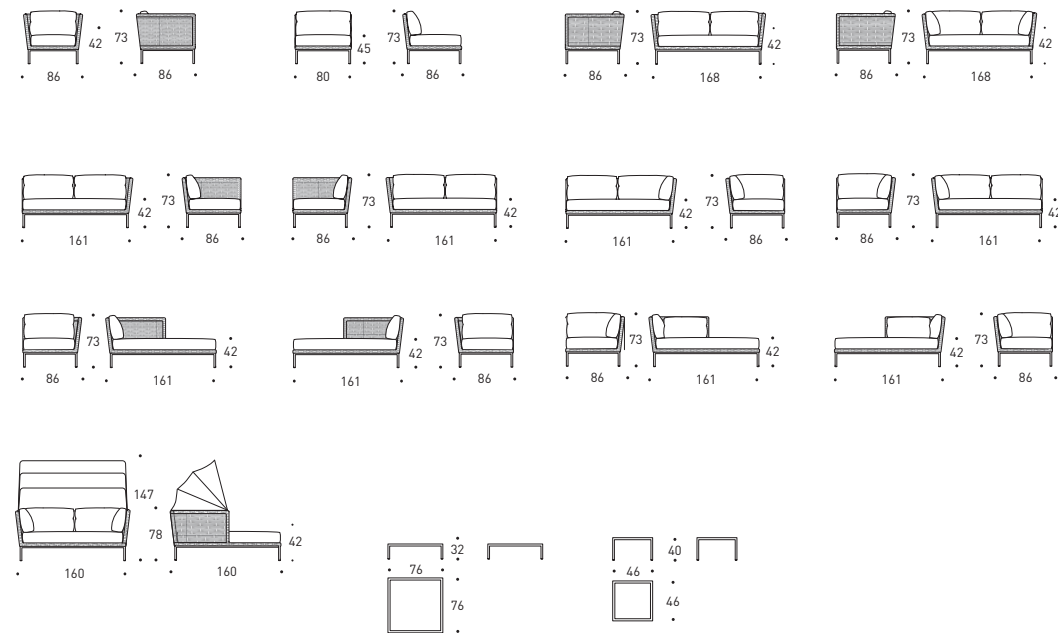



















ARENA_

DESIGN BY R&D VARASCHIN

Collezione intrecciata a mano
in fibra sintetica con intelaiatura in
alluminio verniciato.

*Collection with varnished aluminium
frame and hand woven man-made fibre.*

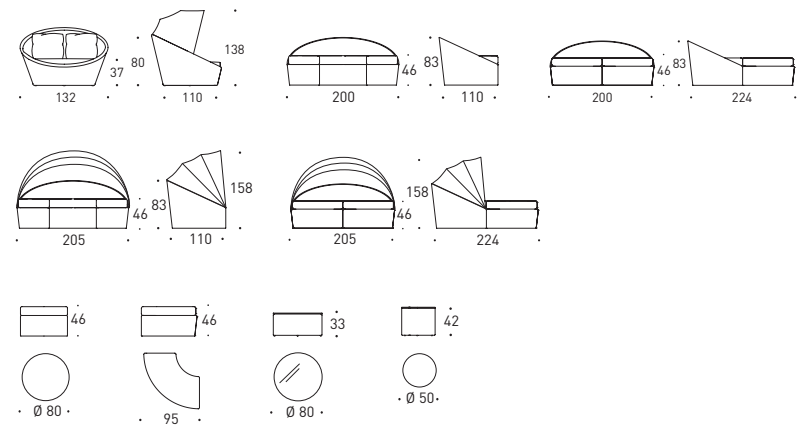













TONKINO_

DESIGN BY R&D VARASCHIN

Collezione intrecciata a mano in fibra sintetica con intelaiatura in alluminio verniciato.

Collection with varnished aluminium frame and hand woven man-made fibre.

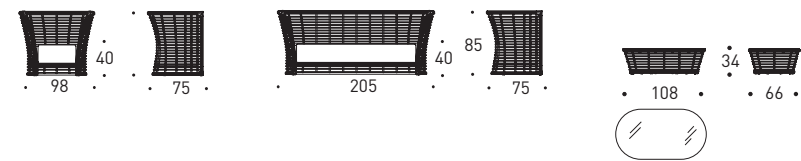







ALTEA_

DESIGN BY R&D VARASCHIN

Collezione intrecciata a mano con intelaiatura in alluminio e fibra sintetica a motivo floreale.

Hand woven collection, aluminium frame and man-made fibre weaving with floral motif.

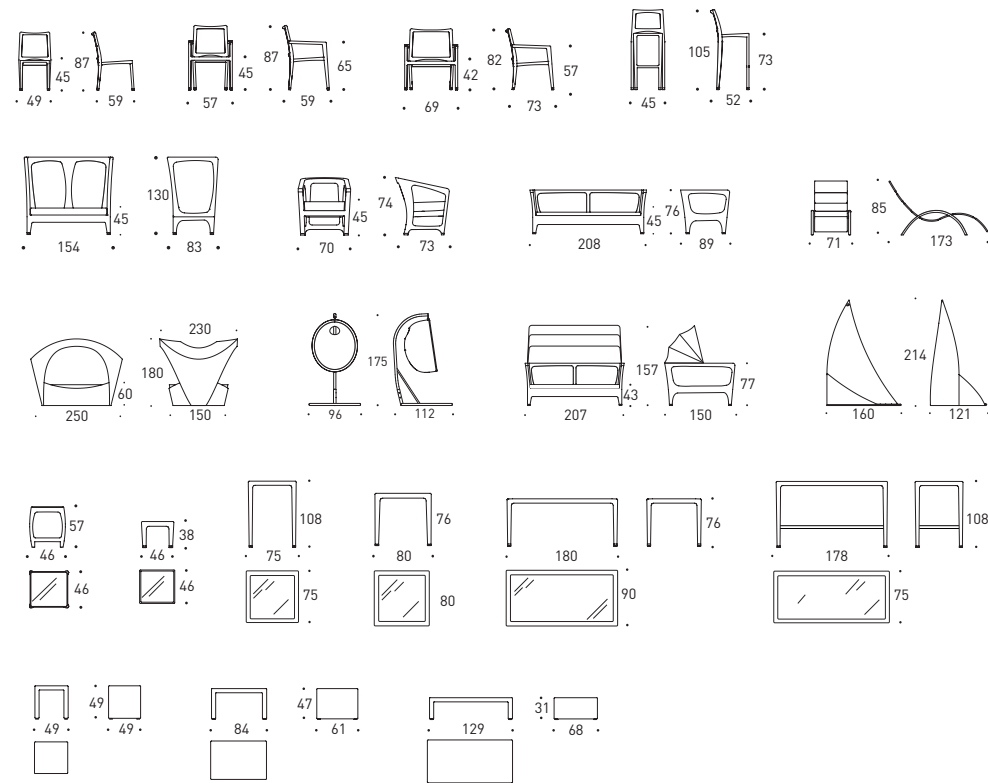















DIVANO-LETTO E NIDO SOSPESO ALTEA / TAVOLINI ARENA_ BED-SOFA AND SWING NEST ALTEA / COFFEE TABLE ARENA



OPEN_



ALTEA







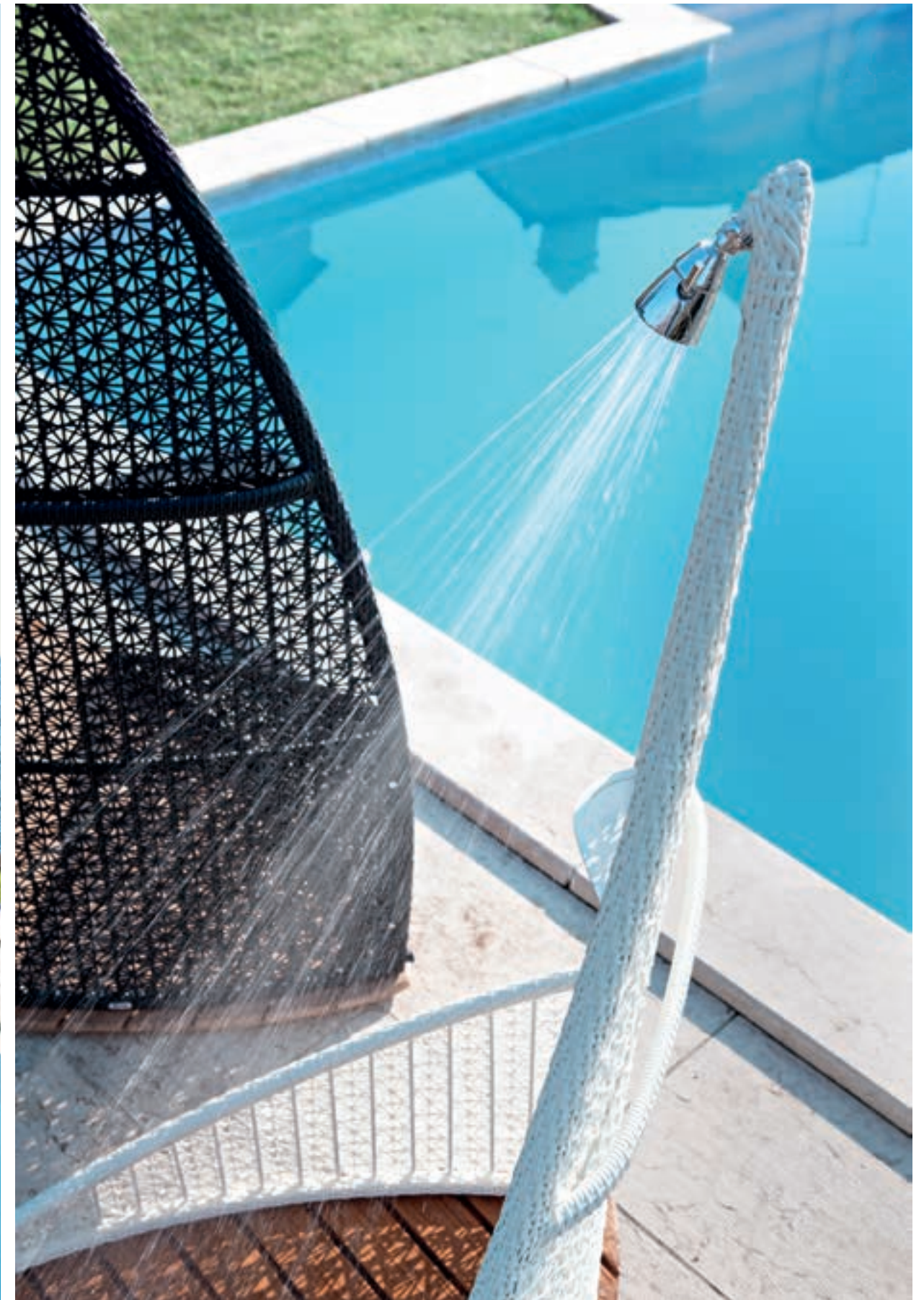

CORA_

DESIGN BY R&D VARASCHIN

Collezione intrecciata a mano in fibra sintetica con intelaiatura in alluminio verniciato.

Collection with varnished aluminium frame and hand woven man-made fibre.

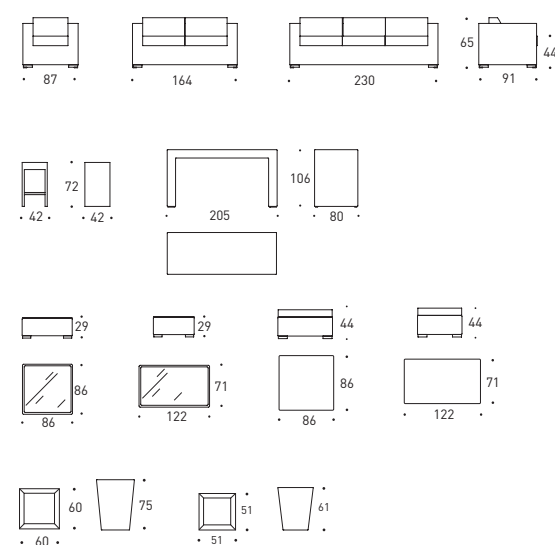













LOTUS_

DESIGN BY R&D VARASCHIN

Collezione intrecciata a mano
in fibra sintetica con intelaiatura in
alluminio verniciato.

*Collection with varnished aluminium
frame and hand woven man-made
fibre.*

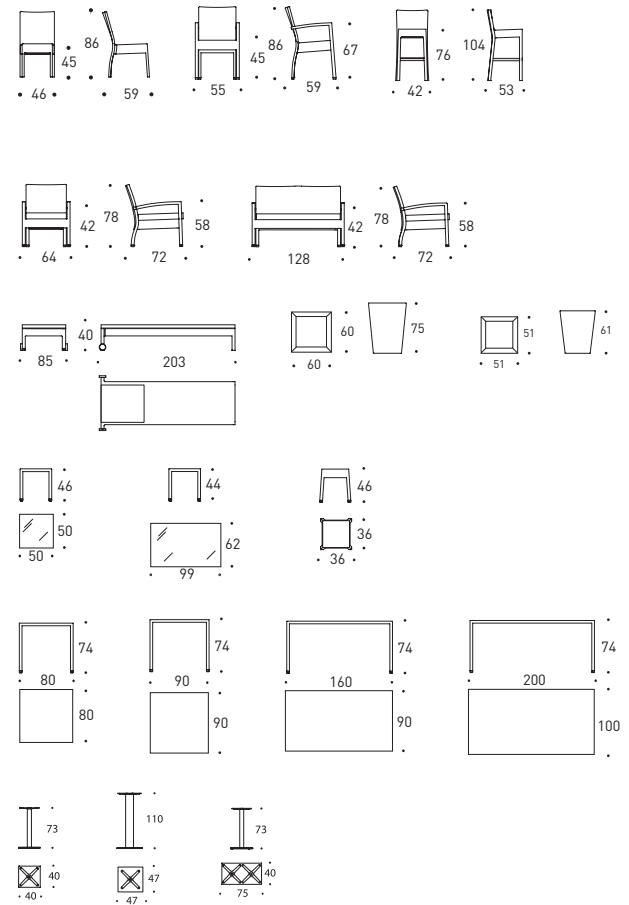



















METRÒ_

DESIGN BY R&D VARASCHIN

Basi tavoli con piani di diverse tipologie e finiture.

Table base with tops of different materials and finishes.

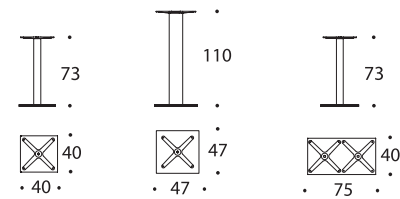



OMBRELLONI E GAZEBO

DESIGN BY R&D VARASCHIN

Collezione di ombrelloni e gazebo con struttura in alluminio completo di tendaggio in poliestere.

Collection of sun umbrellas and gazebo with aluminium frame, complete with polyester curtains.





CAPRI_

Ombrellone braccio laterale retrattile 3x3 mt.
Base in plastica light grey.

*Retractable side arm sun umbrella 3x3 mt.
Light grey plastic base.*



OMBRELLONE CAPRI / LETTINI E TAVOLINI BAHIA_
SUN UMBRELLA CAPRI / SUNBEDS AND COFFEE TABLES BAHIA

AMALFI_

Ombrellone a palo centrale 2,5x2,5 mt.
Base rotonda in graniglia.

*Centrale pole sun umbrella 2,5x2,5 mt.
Round gravel base.*



OMBRELLONE AMALFI / COLLEZIONE BELT / TAVOLINI COLORADO _
SUN UMBRELLA AMALFI / BELT COLLECTION / COFFEE TABLES COLORADO

ISCHIA_

Ombrellone a palo centrale 6x6 mt.
Base in ferro zincato a caldo e verniciato a polveri.

*Centrale pole sun umbrella 6x6mt.
Hot galvanised iron base, powder coated.*



OMBRELLONE ISCHIA / DIVANO, LETTINI E PARAVENTO BELT / TAVOLINO COLORADO / TAVOLINI KNOT / TAVOLO LINK / SEDIE SUMMER SET _
SUN UMBRELLA ISCHIA / SOFA, SUNBEDS AND SCREEN BELT / COFFEE TABLE COLORADO / COFFEE TABLES KNOT / TABLE LINK / CHAIRS SUMMER SET

POSITANO_

Ombrellone a vela 3x3 mt.
Base rotonda in graniglia.

*Sail curtains sun umbrella 3x3mt.
Round gravel base.*

OMBRELLONE POSITANO / LETTINI E TAVOLINO BARCODE _
SUN UMBRELLA POSITANO / SUNBEDS AND COFFEE TABLE BARCODE

COPACABANA_

Ombrellone a braccio laterale 3,5x3,5 mt,
completo di sacco copertura. Base in pietra.

*Side arm sun umbrella 3,5x3,5mt,
with bag cover. Stone base.*



OMBRELLONE COPACABANA / COLLEZIONE BARCODE _
SUN UMBRELLA COPACABANA / BARCODE COLLECTION

OPEN_



OMBRELLONI & GAZEBO

HAWAII_

Hawaii è un gazebo con struttura in acciaio colore moka, completo di tendaggio e predisposto per il fissaggio a terra.

Hawaii is a gazebo in moka metal structure with curtains and equipped to be fixed to the ground.



GAZEBO HAWAII / SEDIA E TAVOLO LOTUS _
GAZEBO HAWAII / CHAIR AND TABLE LOTUS

ALGARVE_ P.008



2230



2231



2232D / 2232S



2233D / 2233S



2234D / 2234S



2235D / 2235S



2237



2237B



2238



2236 / 2239

ALTEA_ P.050



2859



2862



2867



2866



2849



3963



1059



1427



3265



1626



2892 / 2992



3400



3864



3891



3885



3950



3099



3972



3115



3116



3117

ARENA_ P.028



1617



1618



1621



1622



1623



1620



1619



3091



3092

CORA_ P.076



1048



1240



1426



2811



3839



3083P



3084P



3083



3084



4707



4706

LOTUS_ P.090



2816



2817



2880



2850



2851



2803



3975



3976



2852



3840 / 3886



3894 / 3895



3771



3773



3779



4707



4706

METRÒ_ P.110



3751



3752



3753

TONKINO_ P.042



1950



1951



1955

AMALFI_ P.118



4757

CAPRI_ P.116



4759

ISCHIA_ P.120



4760

POSITANO_ P.122



4758

COPACABANA_ P.124



4754 / 4756

HAWAII_ P.126



4740

CREDITS_

AD_ DANIELE LO SCALZO MOSCHERI
STYLING_ CORA VOHWINKEL _ IRENE BARATTO / STUDIOVERDERAME
PHOTO_ MATTEO IMBRIANI _ GIAN PAOLO SERNA
FOTOLITO_ LUCEGROUP.IT
STAMPA_ WWW.SINCROMIA.IT COD. 162501

STAMPA GENNAIO 2017



Varaschin S.p.A

via Cervano 20 / 31029
Vittorio Veneto (TV)
Italia

T_ 39 0438 56 45
F_ 39 0438 564 666

varaschin@varaschin.it
www.varaschin.it