



**OUT -  
DOOR  
THERAPY**

**Varaschin**  
OUTDOOR THERAPY

## Index by Collection

1 9 4	ALGARVE	0 8 4	ELLISSE
2 1 8	AMALFI	0 0 4	EMMA
0 7 8	BABYLON	1 8 8	KENTE
1 1 8	BAHIA	1 0 4	KOLONAKI
0 1 6	BALI	0 2 4	LAPIS
0 3 0	BARCODE	1 0 8	LINK
0 8 8	BELT	1 5 4	MAAT
0 5 2	BENTO	2 1 4	PAVILION
1 6 4	BIG	2 2 0	POSITANO
1 6 0	BIG IN&OUT	1 7 0	SAIA
2 1 2	BIVACCO	0 3 8	SUMMER SET
2 0 4	BLADE	0 9 8	SYSTEM
2 2 2	CAPRI	0 5 8	TIBIDABO
1 2 4	CLEVER	2 0 6	TIGHT
2 1 6	COPACABANA	1 7 8	TOWER
2 2 6	COVER	2 2 4	TRAMA
0 6 8	CRICKET	2 1 0	TUXEDO
1 8 4	DEER	1 3 8	VICTOR
2 0 0	DOLMEN		



Outdoors calls.  
You just have to create  
your extraordinary  
moments.

Non ci sono altri termini per definire la libertà del benessere. Libertà di cultura, di espressione di movimento. Libertà nel vivere la casa, dentro e fuori. Il richiamo degli elementi naturali supera la barriera architettonica e ricorda all'uomo la sua vera origine e la sua missione. Vivere la natura, i suoi colori, i suoi profumi, le sue stagioni. L'attività outdoor è una vera e propria terapia di benessere e rappresenta un'opportunità per qualificare la nostra vita. Solo la passione creativa e la ricerca di stile permette di realizzare un percorso di esclusività e specializzazione.

*There are no other words to describe freedom of wellbeing. Freedom of culture, of expression, of movement. Freedom in living the home, inside and outside. The call of natural elements overcomes the architectural barriers and reminds man of his true origins and mission. Living nature, its colors, its fragrances, its seasons. Outdoor activity is a real well-being therapy and represents an opportunity to qualify our life. Only creative passion and the research for style allow to achieve a path of exclusivity and specialization.*

# /EMMA

design Monica Armani

Famiglia di sedute indoor e outdoor polivalente.

Soluzioni di gambe sia in alluminio che in iroko massello. Tappezzeria della seduta in tessuto o in texture con stampo in polipropilene. Schienali con telai di alluminio verniciati a polveri e rivestiti in texture, tessuto o intrecciati.

MODELLO REGISTRATO

*Multi-purpose indoor and outdoor seating.*

*Leg solutions in both aluminum and solid iroko wood.*

*Fabric or textured fabric upholstery with mold in polypropylene.*

*Backrest with varnished aluminum frames powder coated and covered in texture, fabric or weave.*

REGISTERED MODEL

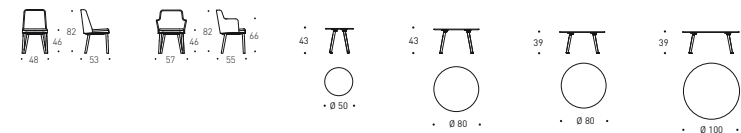













# /BALI

design Alessandro Dubini

Collezione con struttura portante a vista  
in legno massello di teak di piantagione  
certificata. Sedute e schienali imbottiti  
con gomme Dryfeel® da esterno.

MODELLO REGISTRATO

*Collection in plantation certified solid teak  
wood.*

*Padded seat and backs with Dryfeel®  
outdoor foam.*

REGISTERED MODEL









# /LAPIS

design Calvi Brambilla

Collezione con struttura in legno massello di teak di piantagione certificata.  
Scocca con telai di alluminio verniciato a polveri intrecciata a mano, oppure scocca in multistrato di legno per esterni rivestita in tessuto ed imbottita con gomma Dryfeel® da esterno.

MODELLO REGISTRATO

*Collection with structure made of certified plantation solid teak wood. Shell in aluminum, powder coated, hand woven, or outdoor plywood shell upholstered with fabric and Dryfeel® outdoor foam.*

REGISTERED MODEL

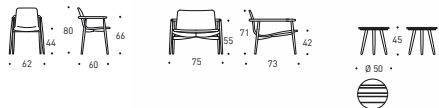







# /BARCODE

design Alessandro Dubini

Collezione composta da divano componibile, lettini, tavolini, consolle e lanterne realizzati in teak di piantagione certificata.

MODELLO REGISTRATO

*Collection of modular sofas, sunbeds, coffee tables, console and lamps made of plantation teak certified.*

*REGISTERED MODEL*

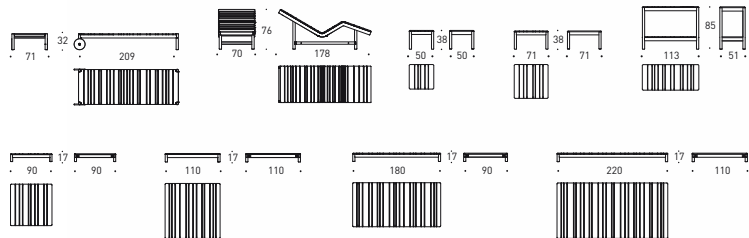







# /SUMMER SET

design Christophe Pillet

Collezione con struttura in tondino di acciaio con trattamento cataforesi verniciato a polveri.

MODELLO REGISTRATO

Collection in cataphoresis treated, powder coated steel rods.

REGISTERED MODEL

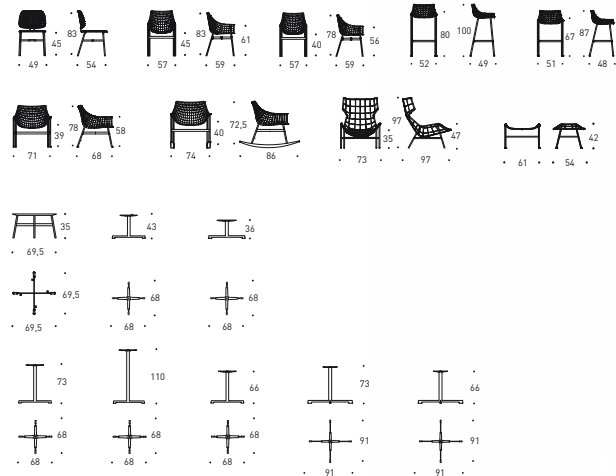

Altezza riferita senza top / Height reported without top















# /BENTO

design Calvi Brambilla

Collezione componibile imbottita con gomme.  
Versione outdoor: struttura portante in legno massello di okumé e imbottitura con gomme Dryfeel® da esterno.  
Versione indoor: struttura portante in legno massello di abete e imbottitura in gomma normale da interno.

Bento si caratterizza per la possibilità di creare molteplici combinazioni che facilmente possono essere definite e successivamente anche modificate a discrezione del Cliente.

È possibile, infatti, con semplici operazioni modificare più volte la combinazione iniziale ricorrendo a piacimento i moduli già acquistati.

Allo stesso modo il Cliente può aggiungere moduli supplementari acquistabili in un secondo momento, rispettando semplicemente le regole di composizione.

MODELLO REGISTRATO

*Modular foam padded collection.*

*Outdoor version: made of okumé solid wood and padded with Dryfeel® outdoor foam.*

*Indoor version: made of fir wood and padded with standard indoor foam.*

*Bento allows you to create multiple combinations that can be defined even at a later stage and modified by the customer. It is, in fact, possible to change the composition on different occasions at your leisure. With the same thought in mind, the customer can add modules in a second moment, clearly respecting the rules of the modular system.*

REGISTERED MODEL

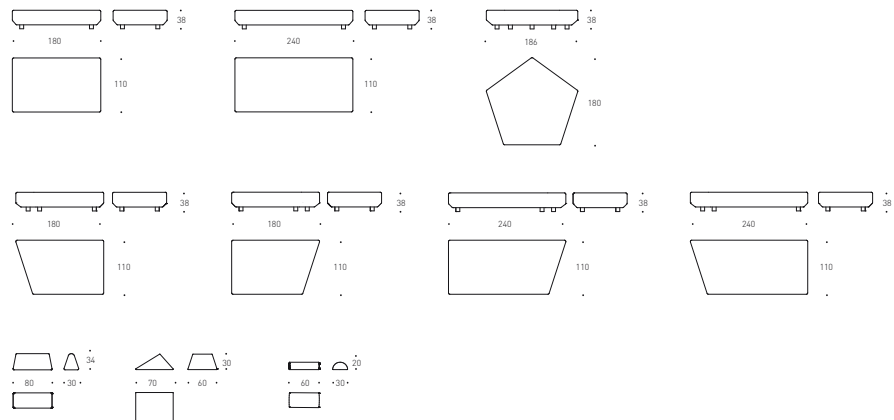





# /TIBIDABO

design Calvi Brambilla

Collezione intrecciata a mano in fibra sintetica con struttura in alluminio verniciato a polveri. Cuscini con imbottitura gomme Dryfeel® da esterno.

MODELLO REGISTRATO

Collection in powder coated aluminium frame and hand woven man-made fibre. Cushions in Dryfeel® outdoor foam.

REGISTERED MODEL

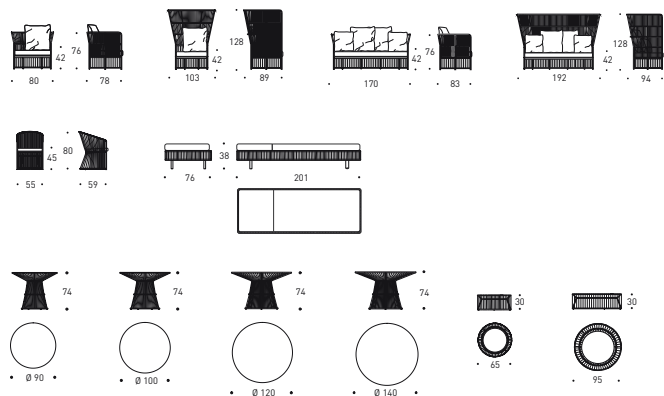

Altezza riferita senza top / Height reported without top













/LOOP  
design Nigel Coates



# /CRICKET

design Anki Gneib

Collezione intrecciata a mano in fibra sintetica  
con intelaiatura in alluminio verniciato.

MODELLO REGISTRATO

Collection with powder coated aluminium  
frame and hand woven man made fibre.

REGISTERED MODEL

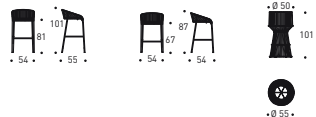









075 / 077

/GRICKET

© 2000 HEAVY



# /BABYLON

design Giopato & Coombes

Collezione di sedute composta da divano, poltrona, pouf, tavolini bassi e lettini in fibra sintetica intrecciata a mano con struttura in alluminio verniciato.

MODELLO REGISTRATO

*Seating collection comprising sofa, armchair, pouf, low occasional tables and sunbeds with aluminium frame and hand woven man-made fibre.*

REGISTERED MODEL

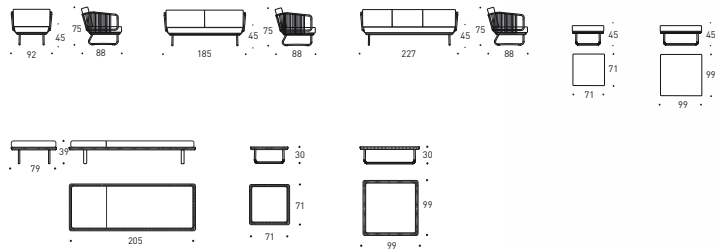





# /ELLISSE

design R&D Varaschin

Collezione tavoli fissi con struttura in alluminio verniciato a polveri con top in Hpl o Ceramica. Disponibili in versione H 74 + top ed in versione Low H 66 + top per essere utilizzati con sedute lounge.

Fixed tables with aluminum, powder coated structure, Hpl or ceramic top. Available in height H74 + top or in the LOW version H66 + top to be used with lounge chairs.

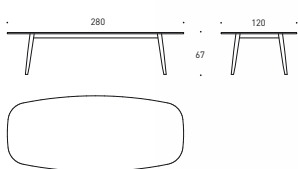
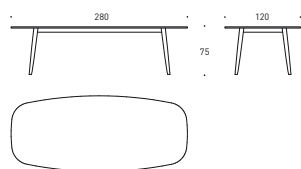
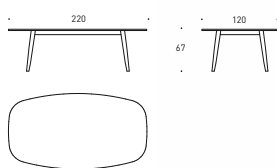
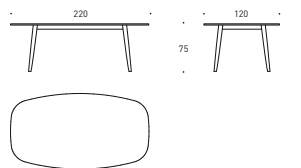

Altezza riferita senza top / Height reported without top



# /BELT

design Daniele Lo Scalzo Moscheri

Collezione imbottita. Versione outdoor:  
struttura portante in legno massello di okumè  
e imbottitura con gomme Dryfeel® da esterni.

Versione indoor: struttura portante in legno massello  
di abete e imbottitura in gomma normale da interno.

Disponibile in versione monotessuto o bitessuto  
con diversi colori.

Per tutti gli articoli della collezione BELT realizzati con due  
tessuti diversi (bitessuto), il prezzo di vendita è determinato  
dalla categoria di tessuto con prezzo più alto.

*Padded modular sofa. Outdoor version:  
framework in solid okoumé wood and padding  
in outdoor Dryfeel® foam.*

*Indoor version: fir wood framework and indoor foam,  
available in mono or bi-fabric version in different colours.*

*Piping in the same fabric as the back/lower part  
of the element (for both mono and bi-fabric  
quilted version).*

*The price of the items manufactured in bi-fabric  
will be the same as the highest fabric category.*

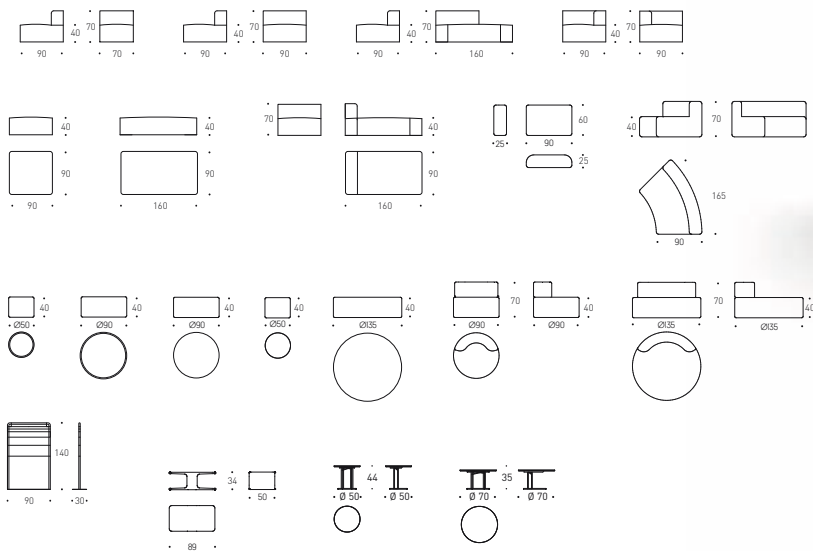

Altezza riferita senza top / Height reported without top













# /SYSTEM

design Daniele Lo Scalzo Moscher

Collezione di tavolini e panche con struttura in alluminio verniciato a polveri con top in Hpl o Ceramica.

Panca disponibile anche imbottita o con seduta in teak di piantagione certificata [solo 178x45].

MODELLO REGISTRATO

*Collection of tables and benches with aluminum structure, powder coated, Hpl or ceramic top. Padded bench is also available or with teak seat from certified plantation [only 178x45].*

REGISTERED MODEL

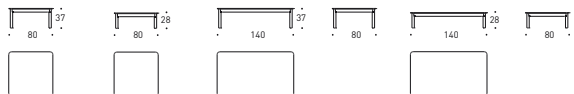
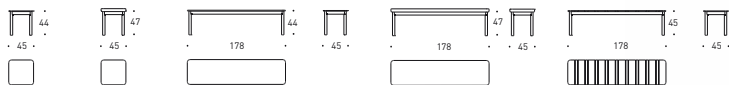





# /KOLONAKI

design Calvi Brambilla

Tavolo con basamento in acciaio trafilato  
piatto trattato cataforesi per esterno,  
verniciatura a polveri.  
Top disponibile in diverse finiture.

MODELLO REGISTRATO

*Table with flat steel wire base, cathoresis  
treated for outdoors, powder coated mat finish.  
Top available in various materials  
and finishes.*

REGISTERED MODEL

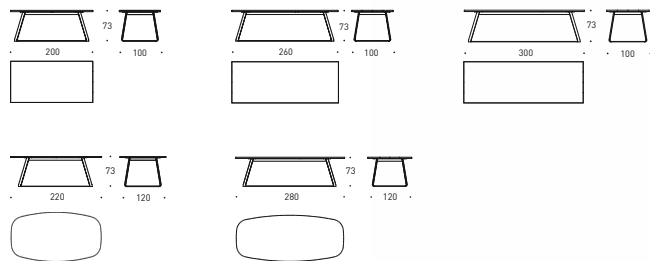

Altezza riferita senza top / Height reported without top





# /LINK

design Alain Gilles

Collezione di tavoli allungabili e fissi, con struttura realizzata in acciaio verniciato a polveri. Gambe disponibili in acciaio e teak. Piani di diverse tipologie e finiture.

MODELLO REGISTRATO

Collection of extending and fixed tables with powder coated steel structure. Legs available in steel and teak. Tops in various materials and finishes.

REGISTERED MODEL

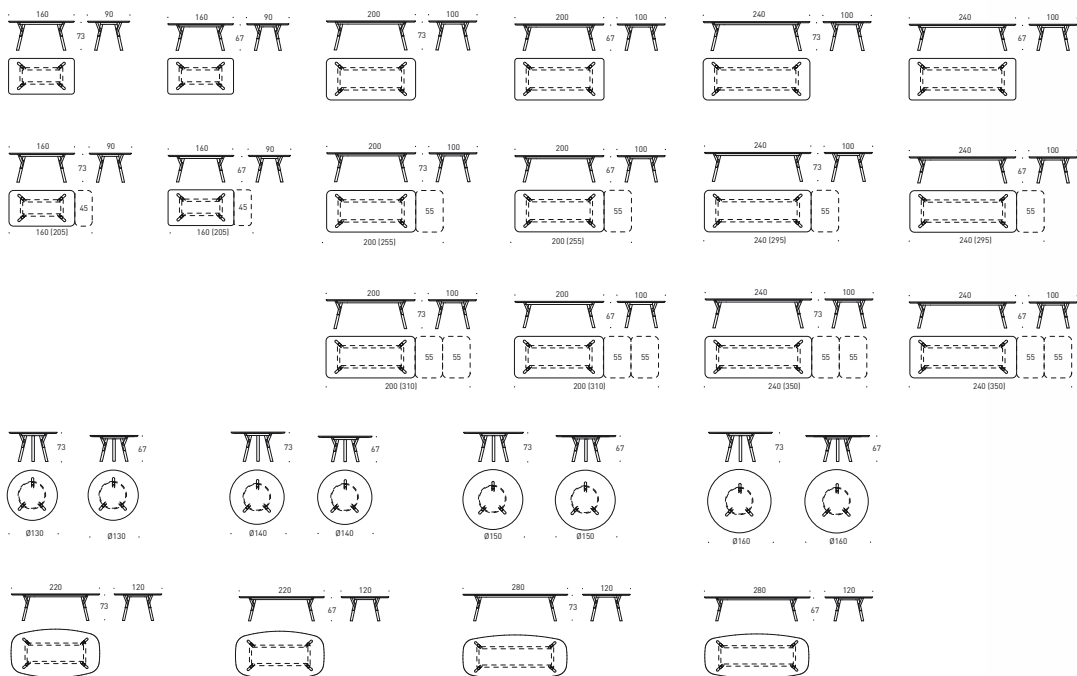

Altezza riferita senza top / Height reported without top









200 mm

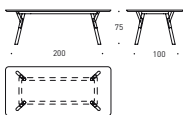

255 mm

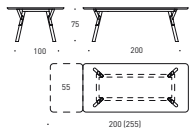

310 mm

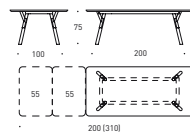



T / H 67  
LOW



# /BAHIA

design Calvi Brambilla

Collezione con struttura in alluminio verniciato a polveri, sedute e schienali in VAR#TEX (tessuto tecnico in PVC).  
MODELLO REGISTRATO

*Collection in powder coated aluminium frame, seat and backrest in VAR#TEX (PVC based material).*  
REGISTERED MODEL

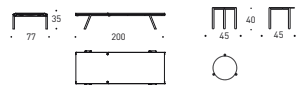





# /CLEVER

design R&D Varaschin

Collezione di sedute composta da poltroncina, poltrone, divano e dondolo con struttura in alluminio verniciato a polveri, sedute e schienali in VAR#TEX [tessuto tecnico in PVC]. Disponibile anche versione con seduta texture e schienale in cordino sintetico.

MODELLO REGISTRATO

*Seating collection composed of chairs, armchairs, sofa and rocking chair with powder coated aluminum frame, seat and back in VAR#TEX [PVC based material].*

*Also available with textylene seat and synthetic rope back.*

REGISTERED MODEL

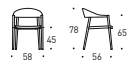





# /CLEVER LOUNGE

design R&D Varaschin

Collezione con struttura in alluminio verniciato a polveri. Sedute e schienali in VAR#TEX.  
Disponibile anche versione con seduta texture e schienale in cordino sintetico.

MODELLO REGISTRATO

*Powder coated aluminium frame armchairs. Seatings and backrests available in VAR#TEX. Textylene seat and synthetic cord back also available.*

REGISTERED MODEL

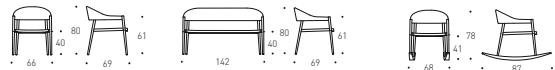







/STRUTTURA GRIGIO  
GREY STRUCTURE



POLTRONCINA / ARMCHAIR  
VAR#TEX CENERE



POLTRONCINA / ARMCHAIR  
VAR#TEX ACQUERELLO



POLTRONCINA / ARMCHAIR  
CORDINO GREY BROWN



DIVANO 2 POSTI / 2 SEATER SOFA  
CORDINO GREY BROWN

/STRUTTURA GRIGIO PERLA  
PEARL GREY STRUCTURE



POLTRONCINA / ARMCHAIR  
VAR#TEX CENERE



POLTRONCINA / ARMCHAIR  
VAR#TEX ACQUERELLO



POLTRONCINA / ARMCHAIR  
CORDINO PERLA



DIVANO / 2 SEATER SOFA  
VAR#TEX ACQUERELLO



DONDOLO POLTRONA LOUNGE  
ROCKING LOUNGE ARMCHAIR  
VAR#TEX CENERE



POLTRONA LOUNGE  
LOUNGE ARMCHAIR  
VAR#TEX CENERE



POLTRONA LOUNGE  
LOUNGE ARMCHAIR  
VAR#TEX ACQUERELLO



POLTRONA LOUNGE  
LOUNGE ARMCHAIR  
CORDINO GREY BROWN



DONDOLO POLTRONA LOUNGE  
ROCKING LOUNGE ARMCHAIR  
CORDINO PERLA



POLTRONA LOUNGE  
LOUNGE ARMCHAIR  
VAR#TEX CENERE



POLTRONA LOUNGE  
LOUNGE ARMCHAIR  
VAR#TEX ACQUERELLO



POLTRONA LOUNGE  
LOUNGE ARMCHAIR  
CORDINO PERLA

# VICTOR

design R&D Varaschin

Collezione con struttura in alluminio verniciato a polveri o teak, sedute e schienali in tessuto traforato batyline, differenti cromie o tessuti resistenti alla tensione.

Collection with powder coated aluminium frame or teak, seat and backrest in batyline in different colours or fabrics resilient to tension.

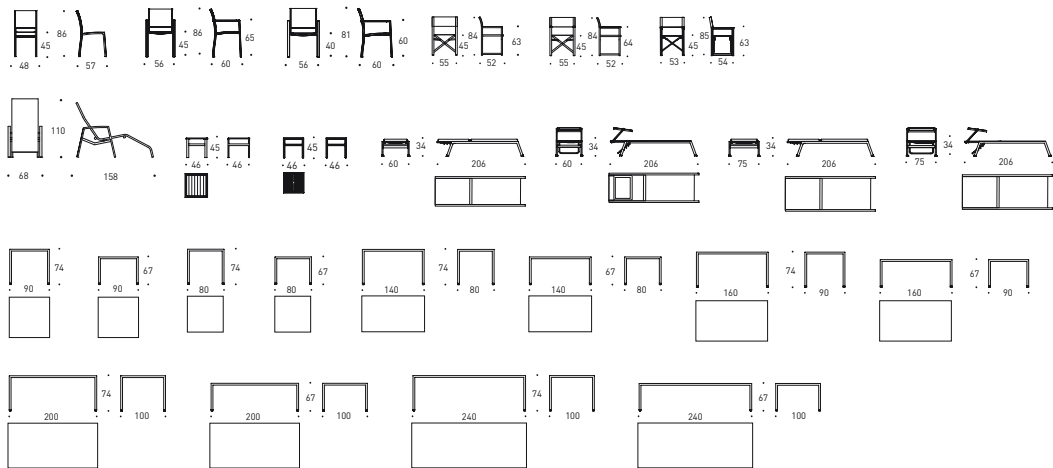

Altezza riferita senza top / Height reported without top











/H 67  
LOW





/ELEMENT  
DESIGN  
ERNESTO  
LECHTHALER





# /MAAT

design Phillippe Bestenheider

Collezione intrecciata a mano in fibra sintetica a quattro colori con intelaiatura in alluminio verniciato a polveri. Cuscini con imbottitura gomme Dryfeel® da esterno.

MODELLO REGISTRATO

*Collection in powder coated aluminium frame and hand woven man-made fibre in four colours. Cushions in Dryfeel outdoor foam.*

REGISTERED MODEL

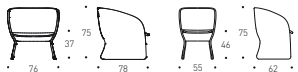







# /BIG IN&OUT

design Ernesto Lechthaler

Collezione composta da tavolo Big Low con piano in Hpl disponibile in diverse finiture o ceramica e 8 poltroncine In&Out monotessuto o bitessuto.

*Collection composed of table Big Low with Hpl and ceramic tops, available in different finishes, and 8 chairs In&Out available in mono-fabric or bi-fabric.*

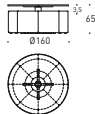



# /BIG

design R&D Varaschin

Base tavolo piatta in acciaio con stelo cilindrico e crociera per fissaggio piano.  
Ciclo protettivo in cataforesi e finitura a polveri.

*Steel table base with flat base and cylindrical stem with cross support for assembling top.  
Cathaphoresic cycle and powder coating.*

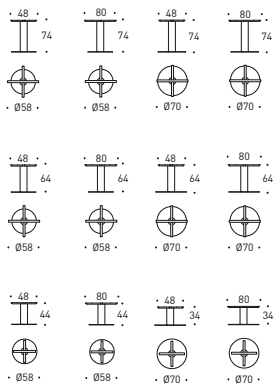

Altezza riferita senza top / Height reported without top





 /H 64  
LOW



# /SAIA

design R&D Varaschin

Collezione con struttura in alluminio verniciata a polveri, sedute e schienali in texture traforato in differenti cromie o tessuti di collezione.

MODELLO REGISTRATO

*Collection with powder coated aluminium frame, seat and backrest in texture fabric in different colours or collection fabrics.*

*REGISTERED MODEL*











# /TOWER

design Anki Gneib

Collezione di basi per tavoli, realizzata in lamiera di acciaio piegata, verniciata a polveri.

*Collection of table bases in folded powder coated steel sheet.*

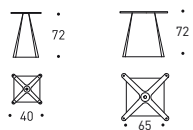

Altezza riferita senza top / Height reported without top





# /DEER

design Anki Gneib

Tavolo con basamento in acciaio trafilato  
piatto trattato cataforesi per esterno,  
verniciatura a polveri.  
Top disponibile in diverse finiture.  
MODELLO REGISTRATO

*Table with flat steel wire base, cathaphoresis  
treated for outdoors, powder coated mat  
finish. Top available in various materials  
and finishes.  
REGISTERED MODEL*

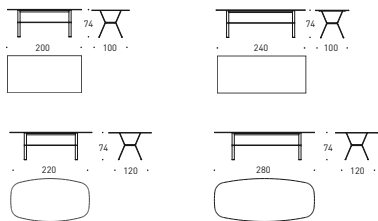

Altezza riferita con top Hpl / Height reported with Hpl top





# /KENTE

design Philippe Bestenheider

Collezione intrecciata a mano, seduta e schienale in fibra sintetica tinta in massa. Struttura in alluminio verniciato a polveri.

MODELLO REGISTRATO

*Hand woven collection, seat and backrest in mass-dyed man-made fibre.*

*Aluminum frames powder coated.*

REGISTERED MODEL

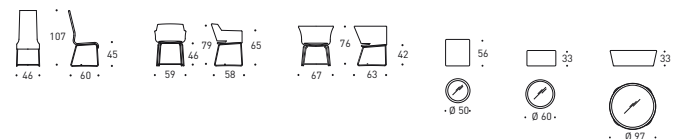
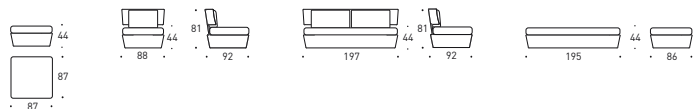







# /ALGARVE

design R&D Varaschin

Collezione in fibra sintetica intrecciata a mano con intelaiatura in alluminio verniciato.

Collection with varnished aluminium frame and hand woven man-made fibre.

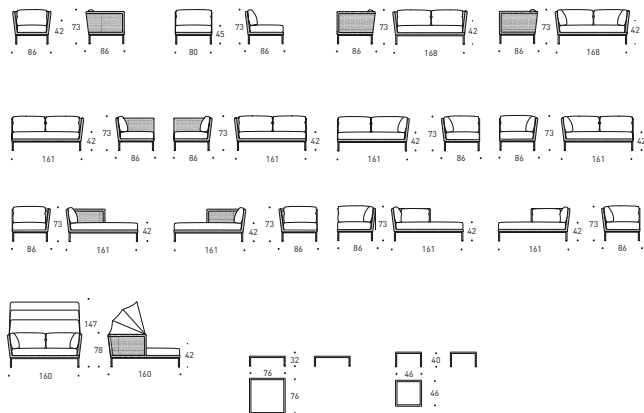





# /DOLMEN

design R&D Varaschin

Tavolo allungabile e fisso con struttura in alluminio verniciato, piano in Hpl.

*Extending and fixed table with varnished aluminium structure, Hpl top.*

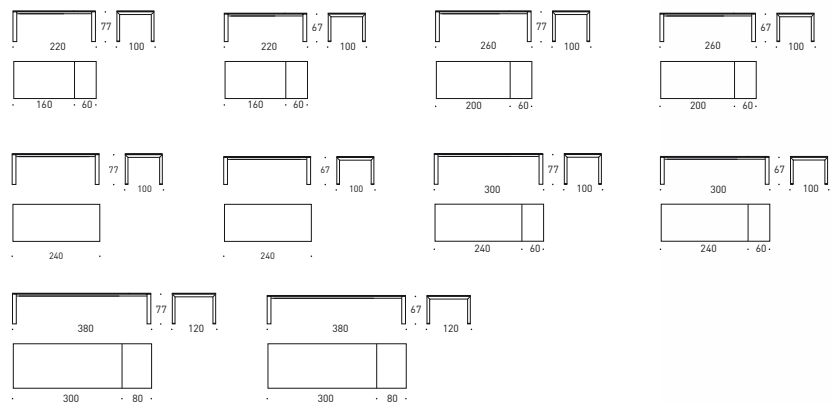

Altezza riferita con top Hpl / Height reported with Hpl top





/H 67  
LOW

# /BLADE

design R&D Varaschin

Base tavolo in acciaio a 4 razze con stelo a sezione quadra e crociera per fissaggio piano. Ciclo protettivo in cataforesi e finitura a polveri.  
Disponibile anche in versione Low (H 66 + top) per essere utilizzati con sedute lounge.

*Steel table base with 4 spoke feet and cross support for the top. Cathaphoresic treatment and powder coating.  
Also available in the Low version (H 66 cms + top) to be used with lounge chairs.*

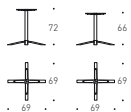

Altezza riferita senza top / Height reported without top





# /TIGHT

design R&D Varaschin

Base tavolo piatta in acciaio con stelo a sezione quadra e crociera per fissaggio piano. Ciclo protettivo in cataforesi e finitura a polveri. Disponibile con piani in Hpl anche in versione Low [H 66 + top] per essere utilizzati con divani e poltrone lounge.

*Flat steel base with squared stem and cross support for assembling table top. Cathaphoresis and powder coating applied. Available with Hpl tops also in Low version [H 66 + top] to be used with sofas and lounge armchairs.*

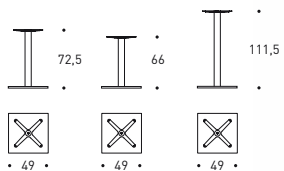

Altezza riferita senza top / Height reported without top



/H 66  
LOW



# /TUXEDO

design Lorenzo Bellini

Base tavolo piatta sagomata in acciaio con stelo a sezione quadra e crociera per fissaggio piano. Ciclo protettivo in cataforesi e finitura a polveri. Disponibile con piani in Hpl anche in versione Low (H 66 + top) per essere utilizzati con divani e poltrone lounge.

*Flat steel shaped base with squared stem and cross support for table top. Cathaphoresis and powder coating applied. Available with Hpl tops and in Low version [H 66 + top] to be use with sofas and lounge armchairs.*

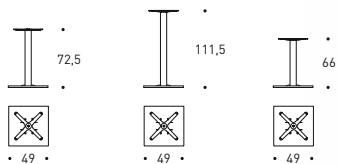

Altezza riferita senza top / Height reported without top



/H 66  
LOW



# /BIVACCO

design R&D Varaschin

Gazebo con struttura in alluminio verniciato bianco completo di tende su 3 lati e tettuccio superiore.  
Materasso di seduta sfoderabile con 2 schienali indipendenti e reclinabili.

*Gazebo with white powder coated aluminum frame with 3 side curtains and sun covering.  
Seat cushion with removable covers and 2 independent and reclining backrests.*

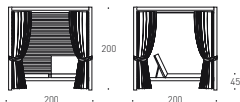

# /PAVILION

design R&D Varaschin

Pavilion è un gazebo con struttura portante realizzata in alluminio, completa di pavimento a doghe, celini frangisole e tende verticali di chiusura.

*Pavilion with aluminium supporting structure, slatted floor, sun coverings and side curtains.*



301



241

328



# /COPACABANA

Ombrellone a braccio laterale 3,5x3,5 mt o 3x4mt,  
completo di sacco copertura. Base in pietra.

*Side arm sun umbrella 3,5x3,5mt or 3x4mt,  
with bag cover. Stone base.*



# /AMALFI

Ombrellone a palo centrale 2,5x2,5 mt.  
Base rotonda in cemento.

Centrale pole sun umbrella 2,5x2,5 mt.  
Round cement base.

# /POSITANO

Ombrellone a vela 3x3 mt. Base rotonda in cemento.

Sail curtains sun umbrella 3x3mt. Round cement base.







# /CAPRI

Ombrellone braccio laterale retrattile 3x3 mt.  
Base in plastica grigia.

*Retractable side arm sun umbrella 3x3 mt.  
Grey plastic base.*



# /TRAMA

design R&D Varaschin

Coperta per esterno con lavorazione maglia rasata. *Outdoor knitted blanket made of 100% Olyna.*  
rasata. Composizione 100% Olyna.



MELANGE BEIGE



TORTORA



MELANGE BRONZO/TABACCO



MELANGE GRIGIO PERLA /  
ANTRACITE



MELANGE OTTANIO/BRONZO

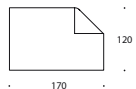

# /COVER

design R&D Varaschin

Le cover dei nostri modelli BELT, BARCODE, BIG IN & OUT, BENTO, adatte alla protezione dei prodotti in ambienti outdoor, sono confezionate su misura alla composizione divano, ordinata dal cliente. Vengono realizzate contemporaneamente al confezionamento del divano stesso, con tessuto poliestere al 100%, 180 grammi a metro quadro, colore grigio chiaro, spalmato un lato con resina acrilica, con trattamento teflon antimacchia ed olio-idrorepellente, studiato e realizzato appositamente per la massima resistenza al passaggio diretto dell'acqua, secondo le indicazioni della normativa tecnica, UNI EN 20811, permeabilità all'acqua, colonna d'acqua maggiore di 1000mm.

*The coverings of our BELT, BARCODE, BIG IN & OUT, BENTO collections are suitable for the protection against atmospheric agents. They are custom-made pieces according to the sofa composition, which is chosen by the customer. Sofa and covering are produced at the same time and are composed 100% of polyester fabrics, with a density of 180 gram per square meter. The polyester fabric is lightgrey and has one side of acrylic resin and Teflon coating, which makes the fabric water and oil proof. These coverings have been designed and created to resist the direct water passage [according to the technical standard UNI EN 20811, the water permeability and the water column test higher than 1000 mm].*

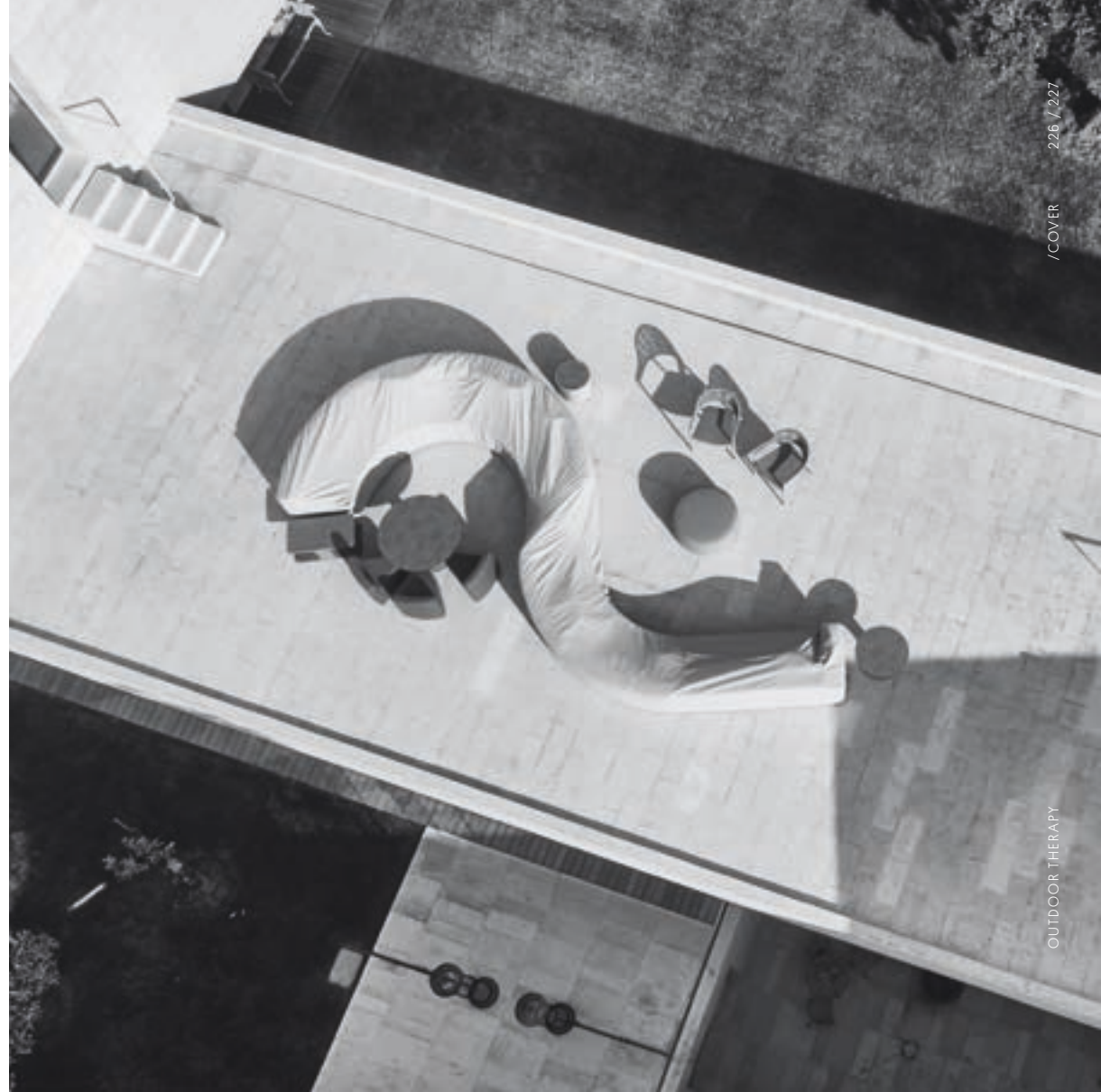

AD Daniele Lo Scalzo Moscheri  
STYLING Cora Vohwinkel / Jennifer Graf  
PHOTO Gian Paolo Serna / Matteo Imbriani / Alessandro Paderni / Riccardo Stocco [photo drone]  
FOTOLITO lucegroup.it  
STAMPA sincromia.it cod.181770

Thanks Lone Hotel, Rovigno, Croazia  
C Hotel, Lecco, Italia  
Casa sull'Albero, Lago di Como, Italia  
Winkler Hotel, Bolzano, Italia  
Antonangeli Illuminazione  
Martinelli Luce  
Vano Alto Design

Stampa ottobre 2018



**Varaschin S.p.A**  
via Cervano 20 / 31029  
Vittorio Veneto (TV) Italia

T 39 0438 56 45  
F 39 0438 564 666

varaschin@varaschin.it  
varaschin.it

