

Guise  
Musa  
North  
Palma

VIBIA



VIBIA

New Collections



Guise  
6

Musa  
20

North  
36

Palma  
46

# Guise

Design by Stefan Diez.

Poetic expression of craft, light, technology and mood.  
Integration of light and material and making it pass  
through in such a way that it becomes invisible and  
then appears out of nowhere.







PENDANTS / COLGANTES



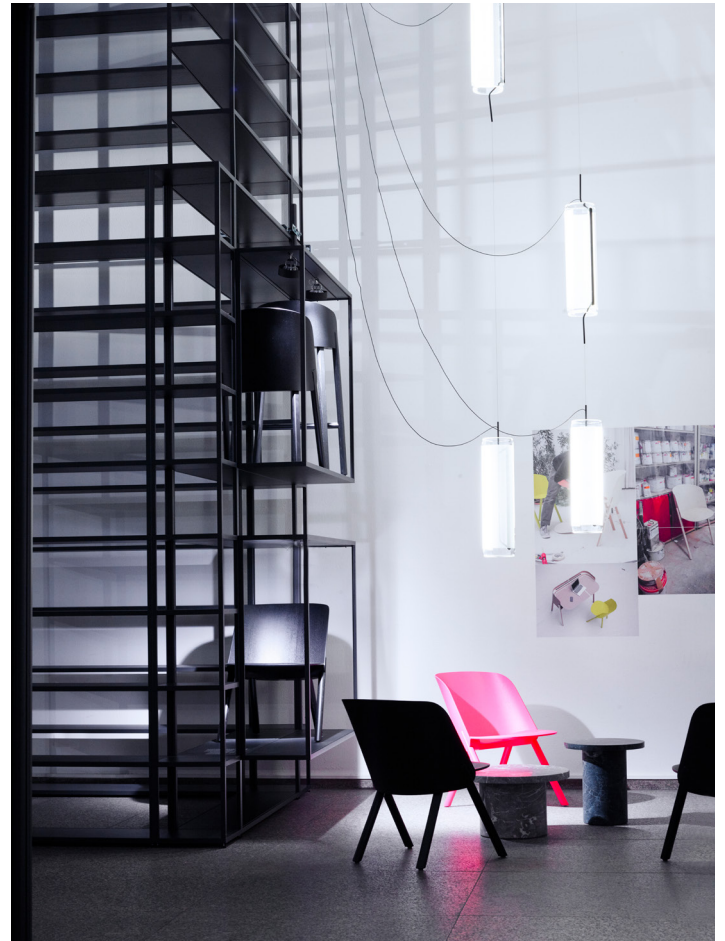



Guise uncovers a new latent potential for LED technology that comes into contact with matter. Through a virtual, magical light with a theatrical effect. The light source is invisible, emanating directly from the material. The glass reveals a luminous interior and a lighting system that performs impeccably in technical terms. When switched off its transparency makes it almost disappear. When switched on it defines a fluid and magnetic luminous presence.

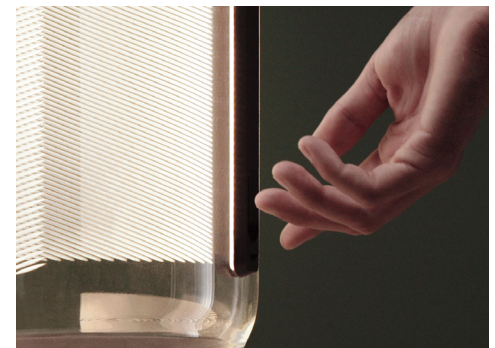
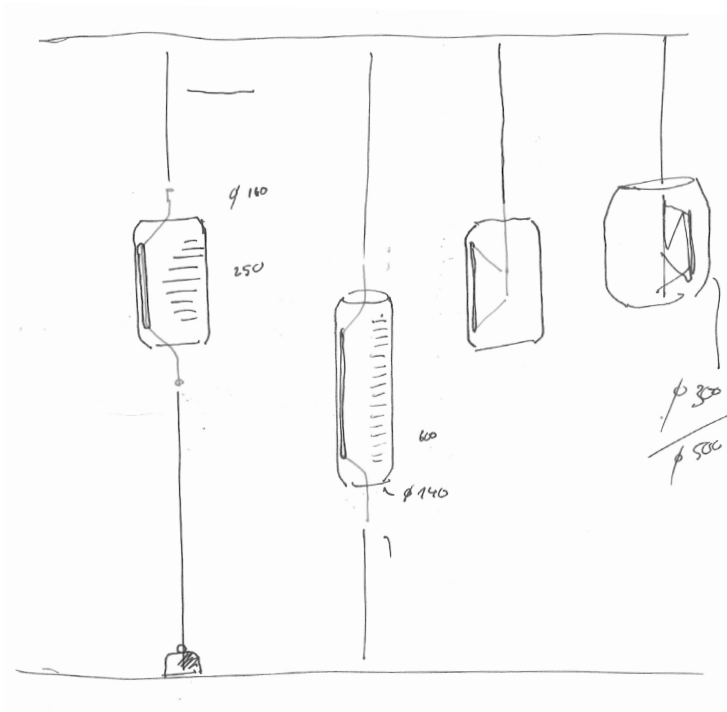
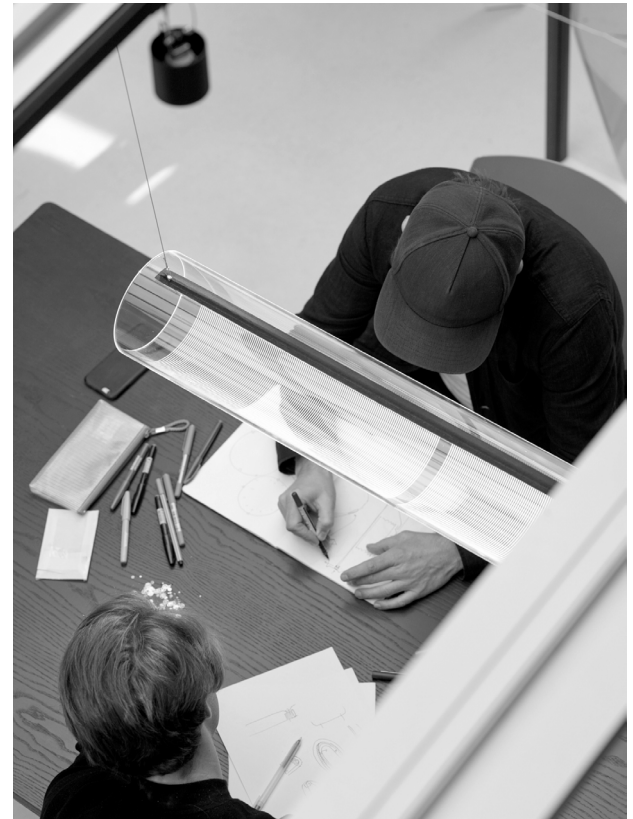

Dimmer: optical sensor.  
Regulable mediante sensor óptico.

“Guise is made possible thanks to the latest LED technology, without which it wouldn’t be possible”, according to Stefan Diez.





The union of physical and virtual worlds comes about through advanced technology which nevertheless remains unseen: latest-generation of LEDs, precision cut glass and striations made on the borosilicate glass surface. This approach to technology culminates with the inclusion of a sensor that allows the intensity to be dimmed by proximity to the object, without the need for actual contact.

La unión de lo material y lo virtual se consigue aplicando alta tecnología y haciendo que ésta devenga invisible: iluminación LED de última generación, corte preciso del vidrio y estriaciones en el vidrio de borosilicato.

El tratamiento tecnológico culmina con la inclusión de un sensor en la propia luminaria que permite regular la luz con la simple aproximación al objeto, sin llegar a tocarlo.

LED 3000 K. CRI >90

Dimmer: optical sensor except 2271, Dimmer: 1-10V.

Regulable mediante sensor óptico excepto 2271 Regulación: 1-10V.

Ref. 2270, 2275, 2277, optional dimming upon request: 1-10V .

Ref. 2270, 2275, 2277, regulación opcional bajo demanda: 1-10V.

● Matt graphite lacquer  
Lacado grafito mate

2270

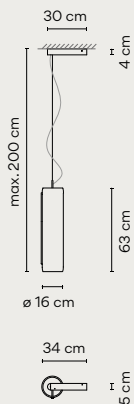

2271

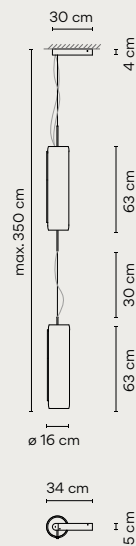

2272

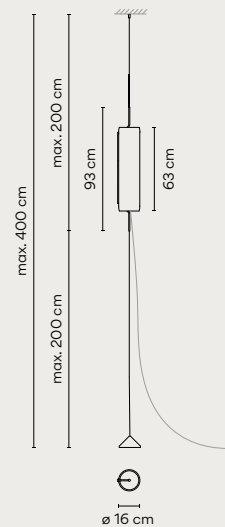

2275

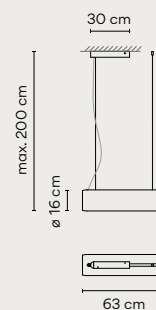

2277

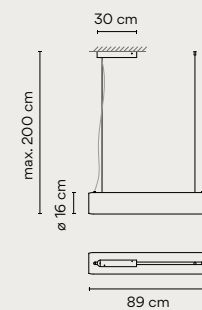

Stefan Diez amalgamates technique and traditions: the glass etching of Bohemia with the pop signage lighting. The contemporary etchings gather and direct the light while the glass reflects it and illuminates. It's both high technology and poetic.

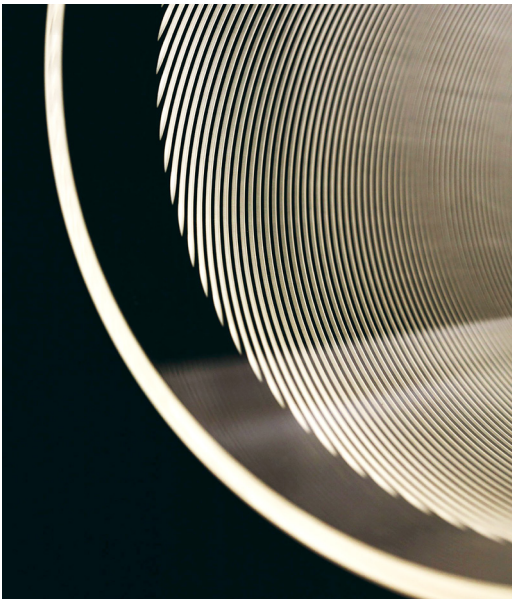

As with the solar eclipse the wall-light version glows with a tangential halo. A glass disc hides the light source and recreates it through a background mural glow. Its simplicity betrays an intensive process of experimentation and trial.





GUISE



This circular indirect wall light with LED technology, integrates light with the borosilicate glass and making it pass through in such a way that it becomes invisible and then allowing it to appear out of nowhere.

Esta luz indirecta circular para paredes con tecnología LED, integra la luz con el material de vidrio de borosilicato y lo hace pasar de tal forma que se vuelve invisible y luego lo deja aparecer de la nada.

LED 3000 K. CRI >90

Dimmer: optical sensor.  
Regulable mediante sensor óptico.

Electric cable with plug.  
Cable eléctrico con enchufe a pared.

● Matt graphite lacquer  
Lacado grafito mate

2260

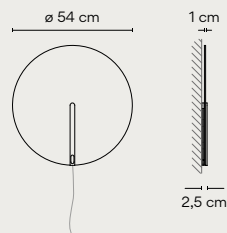

2262

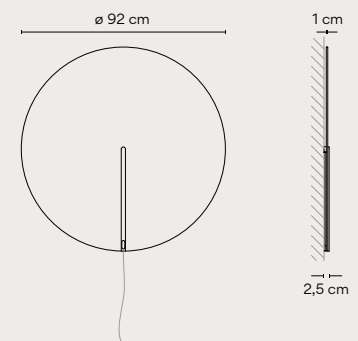

Design by Note Design Studio.

Delicate elegance.

It explores the delicacy of nature which is both strong and powerful, in a poetic expression of light.

# Musa





Note Design Studio has created a delicate but strong light expression. A hint of light emitted by a small glass sphere that expands over the surface that envelops it. A precise composition of two circles: one a light, the other a shadow; one a container, the other the content. It shows how a light object can command the gaze. Its versatility in terms of placing it where it's needed reinforces its poetic formal expression.

“Through this same design process we acquired energy and inspiration and hence the name Musa (Muse)”,  
Note Design Studio.









Portable version with battery.  
Versión portable con batería.

The chromatic range, its shape and subtleties makes a reference to the natural world, makes the shore or the banks of a river. The tonal options increase the warmth of the glow. The bowl, which is slightly textured, captures the light of the small luminous sphere and reflects it over its soft curves. A design that is tactile and warm and appropriate in scale.





## MUSA



The design process and the intensive manual work behind the paper test models lend the finished lamp its organic qualities. The morphology of the plate wraps the light and resolves the dissipation system in an integrative approach.

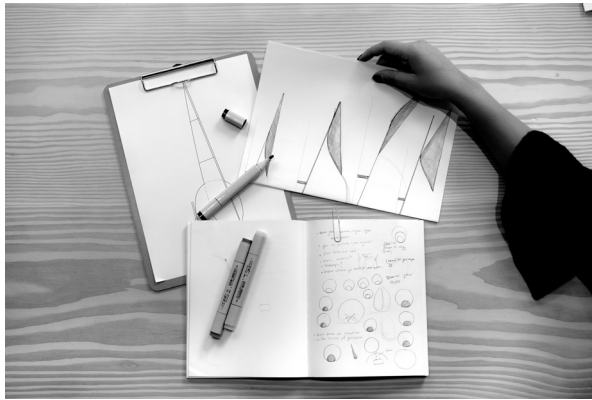
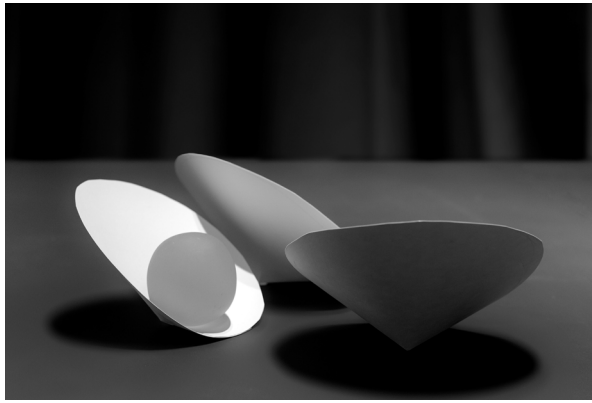





The aluminum base captures the light as the small triple blown-glass matt opal sphere and transforms it into a soft illumination.

La base de aluminio captura la luz de la pequeña esfera de vidrio soplado opal mate tríplex y la transmite en una suave iluminación.

LED 2700 K. CRI>90

Dimmer by push button on the base.  
Regulación mediante pulsador en base.

7404 Portable version with battery.  
Charge by removable cable.  
7404 Versión portable con batería.  
Carga mediante cable extraíble.

- Matt salmon lacquer  
Lacado salmón mate
- Matt mink lacquer  
Lacado visón mate
- Matt white lacquer  
Lacado blanco mate

7400

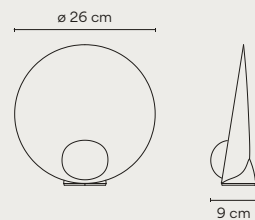

7402 / 7404

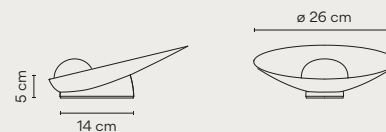

MUSA



Portable version.  
Charge by removable cable.  
Versión portable.  
Carga mediante cable extraíble.









Made of a solid aluminum base, it houses a matt triple blown-glass matt opal diffuser that provides a soft illumination.  
Compuesto por una sólida base de aluminio, acoge un difusor de vidrio soplado opal mate tríplex que transmite una suave iluminación.

- Matt salmon lacquer  
Lacado salmón mate
- Matt mink lacquer  
Lacado visón mate
- Matt white lacquer  
Lacado blanco mate

LED 2700 K. CRI>90

Dimmer: 1-10V.  
Regulación: 1-10V.

7415

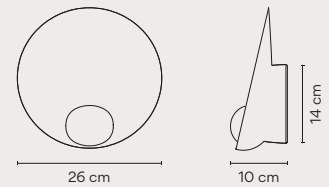

# North Floor-pendant

Design by Arik Levy.

The floor lamp that floats in the air.  
Separating the parts of the luminous object: base, stem  
and shade whereby the light is brought to where it's  
required, allowing each part to be adapted with total  
freedom of movement.



Arik Levy fragments the parts of the lamp and reconfigures them to introduce more variables of light within space. North represents an exercise in utilitarian and poetic deconstruction. The properties of carbon fibre lend technical prowess. Its design skews the air extending the luminous cover and tracing its own space without invading the surrounding area.



The name defines its attributes: a diffused light that casts strength, capturing the gaze and avoiding sharp shadows. Its carefully designed finish makes it warm. The flexible axis guides the light and frames the focus of attention: a unique north light.







North marks a new archetypal light fitting. Combining two typologies, floor and suspension. A floating fitting, hanging from the ceiling in an almost imperceptible way while the electrical connection is provided at floor level. Its habitat is the space in between, where it unfolds in light. Arik Levy has come up with a dynamic system of adjustable angles in order to bring light where it's required. The sharpest angle delimits an intimate area while the more open angle describes a more social and shared space. Elegant and stylish, one of the most subtle floor lamps yet designed.

“North is a system within space. It's like the light from the sun that changes its height and position over the year”, Arik Levy.

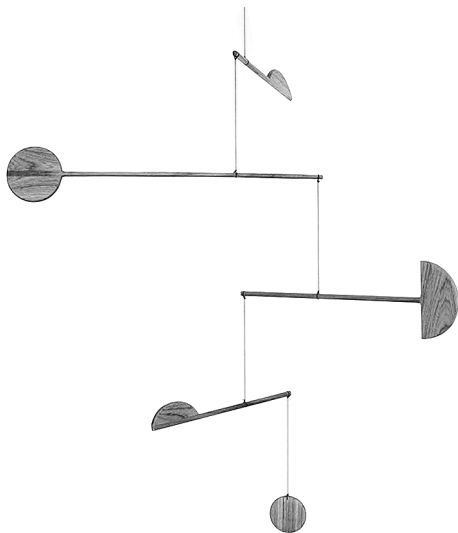

## NORTH FLOOR-PENDANT



The counterweight placed on the ground guides the electrical cable and allows the stem and shade to be placed wherever required.  
El contrapeso en el suelo guía el cable eléctrico y permite colocar la tija y la pantalla en el emplazamiento deseado.

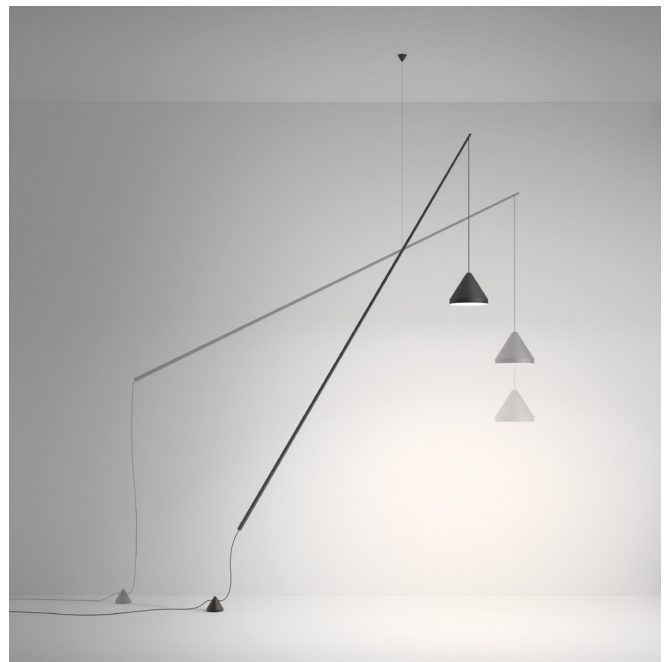



NORTH FLOOR-PENDANT



Suspended from the ceiling via an almost invisible steel cable, the light is equipped with a counterweight placed on the ground that guides the electrical cable and allows the stem and the aluminum shade to be placed wherever required. Carbon fibre rod structure and methacrylate diffuser.

Suspendida del techo mediante un casi invisible cable de acero, la luminaria está equipada con un contrapeso en el suelo que guía el cable eléctrico y permite colocar la tija y la pantalla de aluminio en el emplazamiento deseado. Estructura de fibra de carbono y difusor de metacrilato.

LED 2700 K. CRI>80

Push-button dimmer on the cable.

Cable with plug.

Regulación de intensidad mediante pulsador en el cable eléctrico con enchufe.

- Matt graphite lacquer  
Lacado grafito mate
- Matt blue lacquer  
Lacado azul mate
- Matt cream lacquer  
Lacado crema mate
- Matt white lacquer  
Lacado blanco mate

5666

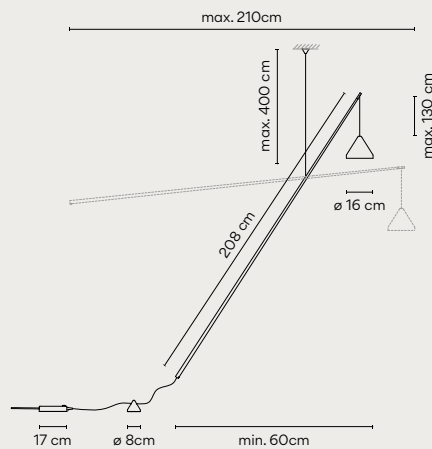

# Palma

Design by Antoni Arola.

The interior ambience takes on a life of its own with the possibility of integrating plants with the lighting compositions.



The design of Palma has at its origin the beauty of hanging gardens. It introduces vegetation associated with indoor lighting. It aims at a re-naturalisation process of our daily environments. Shapes and elemental materials that combine the organic and the immateriality of light. Antoni Arola quotes familiar references, such as Mediterranean rationalism through a cultural sense of continuity. As with a landscape project Palma becomes transformed over time.

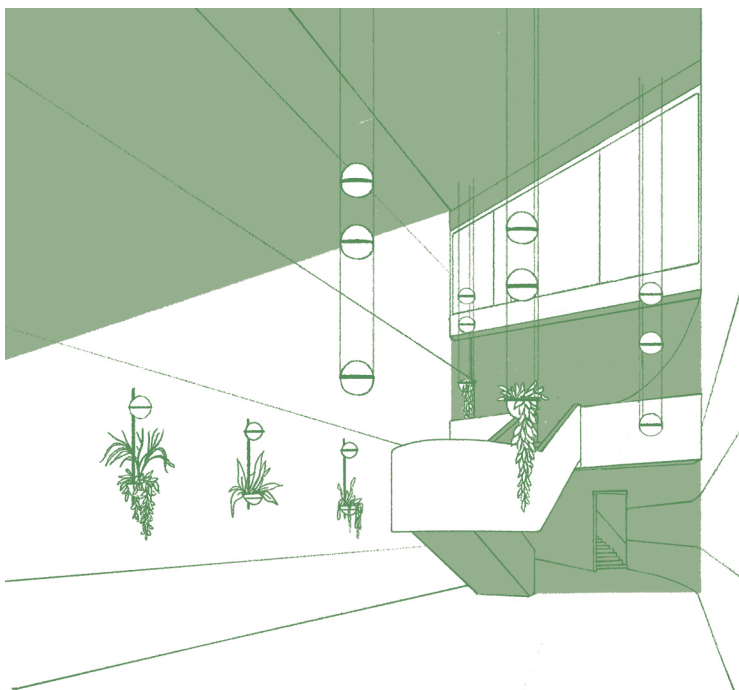

Vertical suspended configurations light the space of a triple-height cultural centre.







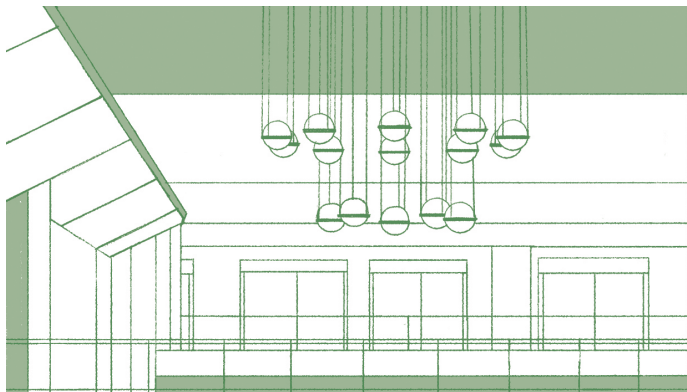

The chandelier version of Palma used to decorate the great hall of a shopping centre.



Palma, in a horizontal axis, generates a relaxing ambience within waiting areas.



“The project follows the intertwining of light and plants, just like it happens in a natural setting”, Antoni Arola.

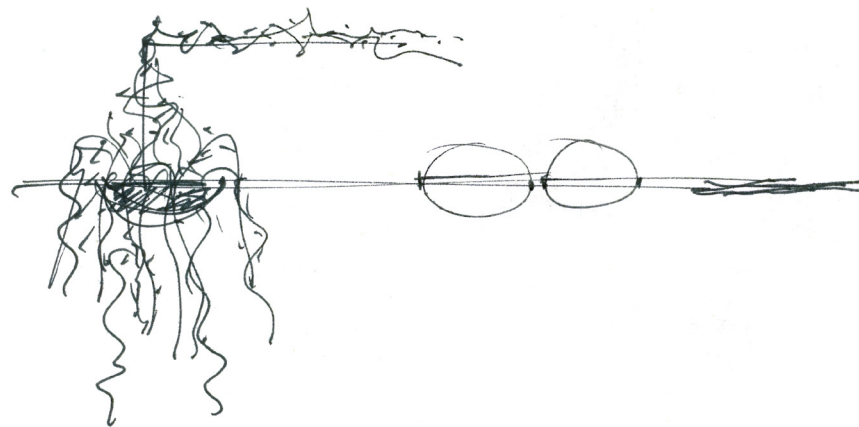

The floating effect is attained through its multiple configurations, the almost imperceptible suspension, a unique cable system and the hoops that wrap the spheres. Its capacity to create ambience increases with additional fixtures like a luminous hanging garden.



## PENDANTS / COLGANTES

Nature takes control of the space. With the pendant lamps the interior ambience takes on a life of its own with the possibility of integrating plants with the lighting compositions.

La naturaleza toma el control del espacio. Con las luminarias colgantes, el ambiente interior adquiere vida propia con la posibilidad de integrar plantas dentro de las composiciones de iluminación.

LED 2700 K. CRI>90

Dimmer: 1-10V, Push.  
Except ref. 3730, 3734, 3736, Dimmer: 1-10V, Push, Dali.

Regulación: 1-10V, Pulsador.  
Excepto ref. 3730, 3734, 3736, Regulación: 1-10V, Pulsador, Dali.

● Matt graphite lacquer  
Lacado grafito mate  
● Matt white lacquer  
Lacado blanco mate

3720

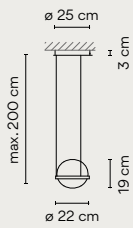

3724

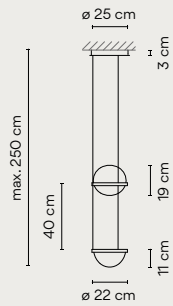

3726

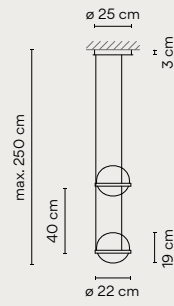

3728

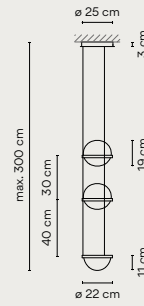

3730

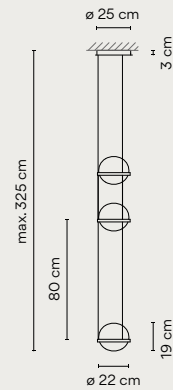

3734

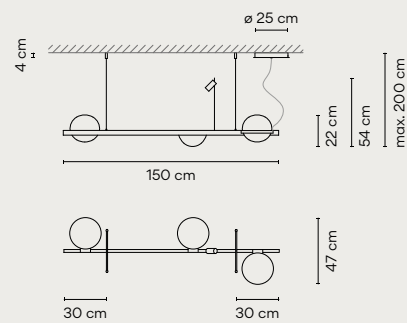

3736

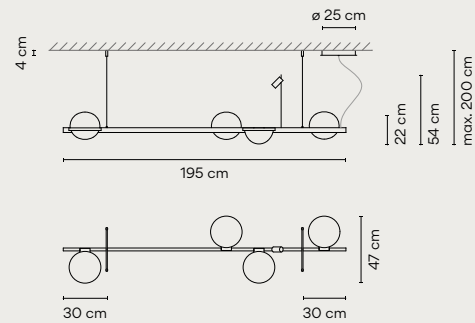



Its timeless sphere of light evolves towards the organic world. Slightly flattened like the shape of the Earth, it gives off a warm and adjustable light. The wall lights redefine the classical globe with new horizontal and vertical fittings on a large scale combined with vegetation.

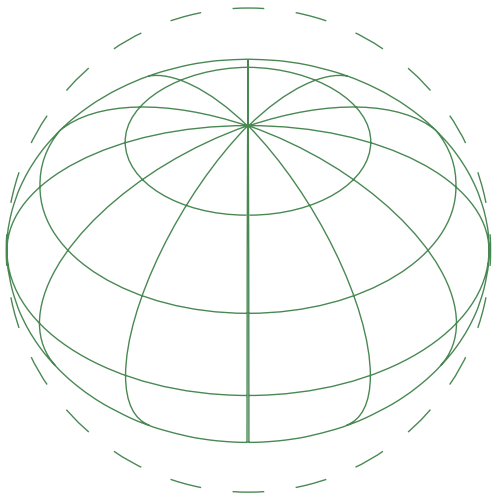



WALL / PARED





Groups of vertical wall sconces calibrate the circulation areas of a residential project.





PALMA







The wall lamps can be installed as an individual fitting or can combine several spheres to create diverse suspended compositions.

Los apliques de pared se pueden instalar como un accesorio individual o combinando varias esferas para crear diversas composiciones suspendidas.

LED 2700 K. CRI>90

Dimmer: 1-10V, Push.

Regulación: 1-10V, Pulsador.

- Matt graphite lacquer  
Lacado grafito mate
- Matt white lacquer  
Lacado blanco mate

3700

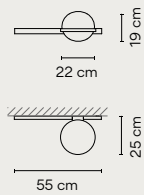

3702

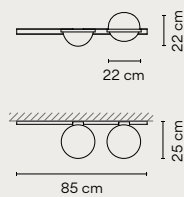

3704

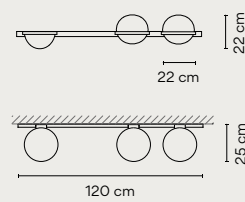

3706

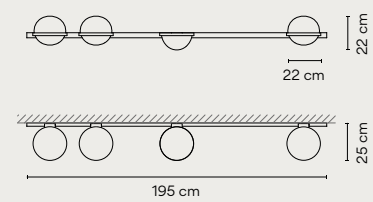

3710

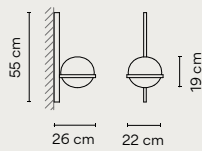

3714

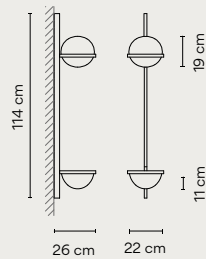

3716

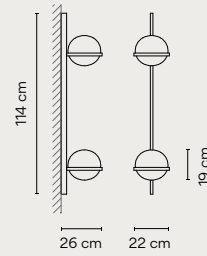

3718

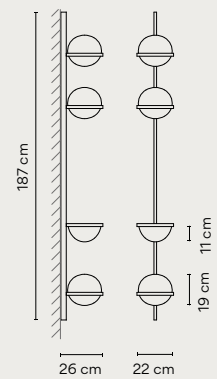

FAMILY







Table lamp with blown glass sphere that gives off a warm lighting effect that takes over interior spaces with a wrap-around luminance that is both comforting and reassuring. Aluminum structure.

Lámpara de sobremesa con esfera de vidrio soplado opal que emite un cálido efecto de iluminación que se apropia de los espacios interiores con una luminancia envolvente que es reconfortante y tranquilizadora. Estructura de aluminio.

LED 2700 K. CRI>90

Dimmer through push in the electric cable with plug.

Regulación intensidad mediante pulsador en el cable eléctrico con enchufe.

3740

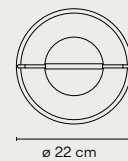
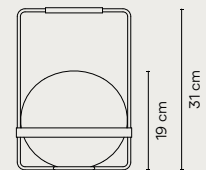

- Matt graphite lacquer  
Lacado grafito mate
- Matt white lacquer  
Lacado blanco mate

# Guise

Design by Stefan Diez.

## Pendants

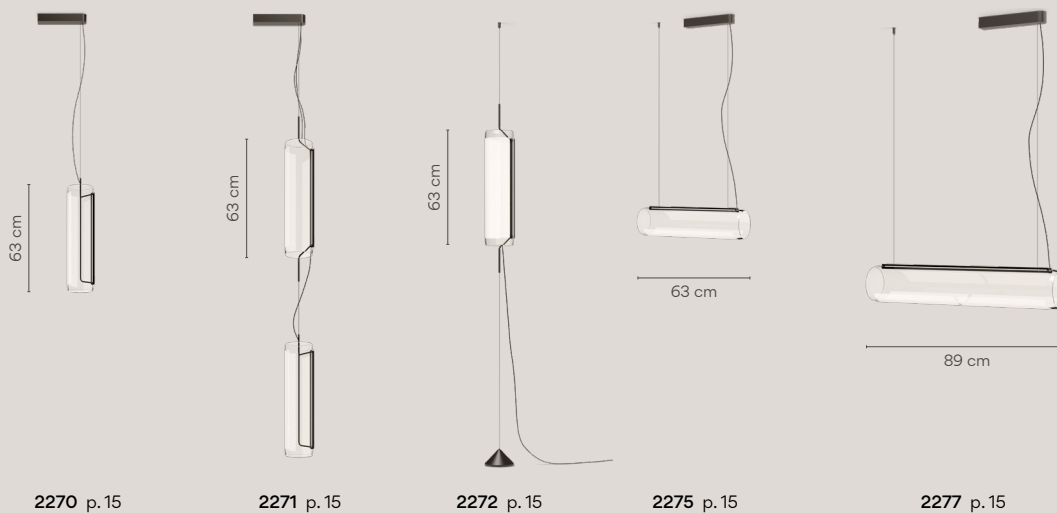

**2270**  
4 x LED STRIP 24V 5W.  
Led 3000 K. CRI >90. 1742,4 lm. 87,12 lm/W.  
Driver Constant Voltage 24V. 110-240V. 50/60Hz.  
Dimmer Optical Sensor

Diffuser: Borosilicate glass.  
Body: Aluminum.  
Weight 5 Kg.

**2270 18 /26** Matt graphite lacquer (ADAPTA RF9913WX)

LED IP20 CE Dimmer A\*

**2271**  
8 x LED STRIP 24V 5W.  
Led 3000 K. CRI >90. 3484,8 lm. 87,12 lm/W.  
Driver Constant Voltage 24V. 110-240V. 50/60Hz.  
Dimmer 1 - 10 V.

Diffuser: Borosilicate glass.  
Body: Aluminum.  
Weight 9,5 Kg.

**2271 18 /23** Matt graphite lacquer (ADAPTA RF9913WX)

LED IP20 CE Dimmer A\*

**2272**  
4 x LED STRIP 24V 5W.  
Led 3000 K. CRI >90. 1742,4 lm. 87,12 lm/W.  
Driver Constant Voltage 24V. 100-240V. 50/60Hz.  
Dimmer Optical Sensor  
Electric cable with plug

Diffuser: Borosilicate glass.  
Body: Aluminum.  
Weight 5 Kg.

**2272 18 /26** Matt graphite lacquer (ADAPTA RF9913WX)

LED IP20 CE Dimmer A\*

**2275**  
4 x LED STRIP 24V 5W.  
Led 3000 K. CRI >90. 1742,4 lm. 87,12 lm/W.  
Driver Constant Voltage 24V. 110-240V. 50/60Hz.  
Dimmer Optical Sensor

Diffuser: Borosilicate glass.  
Body: Aluminum.  
Weight 5 Kg.

**2275 18 /26** Matt graphite lacquer (ADAPTA RF9913WX)

LED IP20 CE Dimmer A\*

**2277**  
6 x LED STRIP 24V 5W.  
Led 3000 K. CRI >90. 2613,6 lm. 87,12 lm/W.  
Driver Constant Voltage 24V. 110-240V. 50/60Hz.  
Dimmer Optical Sensor

Diffuser: Borosilicate glass.  
Body: Aluminum.  
Weight 7,5 Kg.

**2277 18 /26** Matt graphite lacquer (ADAPTA RF9913WX)

LED IP20 CE Dimmer A\*

Wall

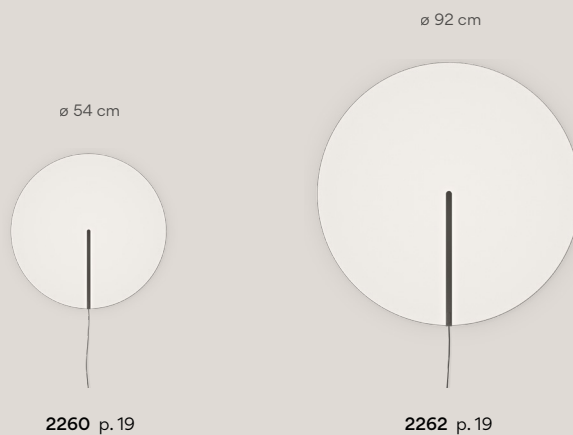

**2260**  
2 x LED STRIP 24V 5W.  
**Led** 3000 K. CRI >90. 871,2 lm. 87,12 lm/W.  
**Driver** Constant Voltage 24V. 100-240V. 50/60Hz.  
**Dimmer** Optical Sensor  
Electric cable with plug

Diffuser: Borosilicate glass.  
Body: Aluminum.  
Weight 4 Kg.

**2260 18 /26** Matt graphite lacquer (ADAPTA RF9913WX)



**2262**  
2 x LED STRIP 24V 3,6W.  
2 x LED STRIP 24V 5W.  
**Led** 3000 K. CRI >90. 1504,8 lm. 87,12 lm/W  
**Driver** Constant Voltage 24V. 100-240V. 50/60Hz.  
**Dimmer** Optical Sensor  
Electric cable with plug

Diffuser: Borosilicate glass.  
Body: Aluminum.  
Weight 11,58 Kg.

**2262 18 /26** Matt graphite lacquer (ADAPTA RF9913WX)



# North Floor-pendant

Design by Arik Levy.

Floor

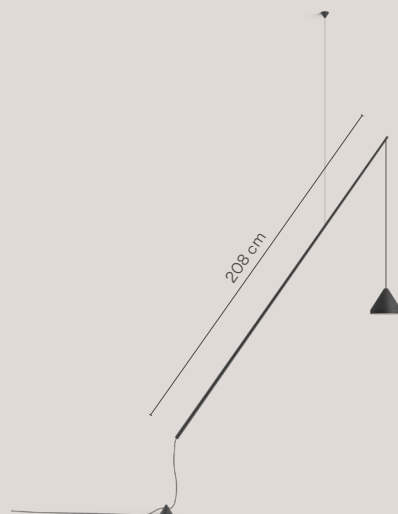

5666 p. 45

## 5666

1 x LED 9W 350mA.

Led 2700 K, CRI >80. 1041 lm. 116 lm/W.

Driver Constant Current 350 mA. 110-240V. 50/60Hz.

Dimmer Push

Electric cable with plug

Diffuser: Methacrylate. Screen: Aluminum

Cane: Carbon fiber.

Weight 4,05 Kg.

5666 04 /15 Matt graphite lacquer (NCS S8500N)



5666 05 /15 Matt blue lacquer (NCS 3040-B10G)



5666 58 /15 Matt cream lacquer (NCS S 2005-Y20R)



5666 93 /15 Matt white lacquer (NCS S 0502-Y)



































LED IP20 CE Dimmer A\*

# Musa

Design by Note Design Studio.

Table  
Wall



<p><b>7400</b> 1 x LED 4,5W 350mA. Led 2700 K. CRI &gt;90. 449 lm. 99,7 lm/W. Driver Constant Voltage 24V. 100-240V. 50/60Hz. Dimmer Push Electric cable with plug</p>	<p>Diffuser: Blown glass. Body: Aluminum. Weight 0,85 Kg.</p>	<p><b>7400 58 /15</b> Matt salmon lacquer (NCS S 1010-Y50R)   <b>7400 59 /15</b> Matt mink lacquer (NCS S2005-Y50R)   <b>7400 93 /15</b> Matt white lacquer (RAL 9016)       </p>
<p><b>7402</b> 1 x LED 4,5W 350mA. Led 2700 K. CRI &gt;90. 449 lm. 99,7 lm/W. Driver Constant Voltage 24V. 100-240V. 50/60Hz. Dimmer Push Electric cable with plug</p>	<p>Diffuser: Blown glass. Body: Aluminum. Weight 0,85 Kg.</p>	<p><b>7402 58 /15</b> Matt salmon lacquer (NCS S 1010-Y50R)   <b>7402 59 /15</b> Matt mink lacquer (NCS S2005-Y50R)   <b>7402 93 /15</b> Matt white lacquer (RAL 9016)       </p>
<p><b>7404</b> 1 x LED 2,1W 700mA. Led 2700 K. CRI &gt;90. 238 lm. 113 lm/W. Driver Constant Voltage 5V. 100-240V. 50/60 Hz. Dimmer Push Portable version with battery Electric cable with plug</p>	<p>Diffuser: Blown glass. Body: Aluminum. Weight 0,95 Kg.</p>	<p><b>7404 58 /15</b> Matt salmon lacquer (NCS S 1010-Y50R)   <b>7404 59 /15</b> Matt mink lacquer (NCS S2005-Y50R)   <b>7404 93 /15</b> Matt white lacquer (RAL 9016)        </p>
<p><b>7415</b> 1 x LED 4,5W 350mA. Led 2700 K. CRI &gt;90. 449 lm. 99,7 lm/W. Driver Constant Current 350 mA. 220-240V. 50/60 Hz. Dimmer 1 - 10 V.</p>	<p>Diffuser: Blown glass. Body: Aluminum. Weight 1,3 Kg.</p>	<p><b>7415 58 /13</b> Matt salmon lacquer (NCS S 1010-Y50R)   <b>7415 59 /13</b> Matt mink lacquer (NCS S2005-Y50R)   <b>7415 93 /13</b> Matt white lacquer (RAL 9016)       </p>

# Palma

Design by Antoni Arola.

Wall

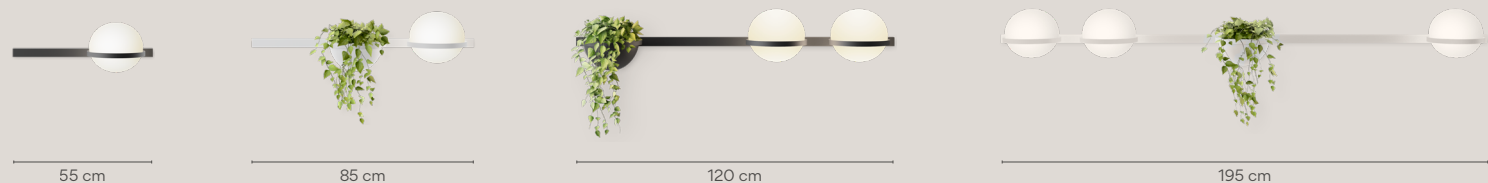

3700 p. 63

3702 p. 63

3704 p. 63

3706 p. 63

**3700**  
2 x LED 4,6W 500mA.  
Led 2700 K. CRI >90. 868 lm. 93 lm/W.  
Driver Constant Current 500 mA. 110-240V. 50/60Hz.  
Dimmer 1-10V + Push

Diffuser: Blown-glass. Profile: Aluminum.  
Weight 1,8 Kg.

**3700 18 /1B** Matt graphite lacquer (ADAPTA RF 9913 WX)

**3700 93 /1B** Matt white lacquer (RAL 9016)

LED IP20 CE Dimmer A+

**3702**  
2 x LED 4,6W 500mA.  
Led 2700 K. CRI >90. 868 lm. 93 lm/W.  
Driver Constant Current 500 mA. 110-240V. 50/60Hz.  
Dimmer 1-10V + Push

Diffuser: Blown-glass. Profile: Aluminum.  
Planter: PMMA.  
Weight 2,4 Kg.

**3702 18 /1B** Matt graphite lacquer (ADAPTA RF 9913 WX)

**3702 93 /1B** Matt white lacquer (RAL 9016)

LED IP20 CE Dimmer A+

**3704**  
4 x LED 4,6W 500mA.  
Led 2700 K. CRI >90. 1736 lm. 93 lm/W.  
Driver Constant Current 500 mA. 110-240V. 50/60Hz.  
Dimmer 1-10V + Push

Diffuser: Blown-glass. Profile: Aluminum.  
Planter: PMMA.  
Weight 3,9 Kg.

**3704 18 /1B** Matt graphite lacquer (ADAPTA RF 9913 WX)

**3704 93 /1B** Matt white lacquer (RAL 9016)

LED IP20 CE Dimmer A+

**3706**  
6 x LED 4,6W 500mA.  
Led 2700 K. CRI >90. 2604 lm. 93 lm/W.  
Driver Constant Current 500 mA. 110-240V. 50/60Hz.  
Dimmer 1-10V + Push

Diffuser: Blown-glass. Profile: Aluminum.  
Planter: PMMA.  
Weight 3,9 Kg.

**3706 18 /1B** Matt graphite lacquer (ADAPTA RF 9913 WX)

**3706 93 /1B** Matt white lacquer (RAL 9016)

LED IP20 CE Dimmer A+

Wall



**3710**  
 2 x LED 4,6W 500mA.  
 Led 2700 K. CRI >90. 868 lm. 93 lm/W.  
 Driver Constant Current 500 mA. 110-240V. 50/60Hz.  
 Dimmer 1-10V + Push

Diffuser: Blown-glass. Profile: Aluminum.  
 Weight 1,8 Kg.

**3710 18 /1B** Matt graphite lacquer (ADAPTA RF 9913 WX)

**3710 93 /1B** Matt white lacquer (RAL 9016)

LED IP20 CE Dimmer A+

**3714**  
 2 x LED 4,6W 500mA.  
 Led 2700 K. CRI >90. 868 lm. 93 lm/W.  
 Driver Constant Current 500 mA. 110-240V. 50/60Hz.  
 Dimmer 1-10V + Push

Diffuser: Blown-glass. Profile: Aluminum.  
 Planter: PMMA.  
 Weight 2,9 Kg.

**3714 18 /1B** Matt graphite lacquer (ADAPTA RF 9913 WX)

**3714 93 /1B** Matt white lacquer (RAL 9016)

LED IP20 CE Dimmer A+

**3716**  
 4 x LED 4,6W 500mA.  
 Led 2700 K. CRI >90. 1736 lm. 93 lm/W.  
 Driver Constant Current 500 mA. 110-240V. 50/60Hz.  
 Dimmer 1-10V + Push

Diffuser: Blown-glass. Profile: Aluminum.  
 Weight 4,2 Kg.

**3716 18 /1B** Matt graphite lacquer (ADAPTA RF 9913 WX)

**3716 93 /1B** Matt white lacquer (RAL 9016)

LED IP20 CE Dimmer A+

**3718**  
 6 x LED 4,6W 500mA.  
 Led 2700 K. CRI >90. 2604 lm. 93 lm/W.  
 Driver Constant Current 500 mA. 110-240V. 50/60Hz.  
 Dimmer 1-10V + Push

Diffuser: Blown-glass. Profile: Aluminum.  
 Planter: PMMA.  
 Weight 6,1 Kg.

**3718 18 /1B** Matt graphite lacquer (ADAPTA RF 9913 WX)

**3718 93 /1B** Matt white lacquer (RAL 9016)

LED IP20 CE Dimmer A+

Pendants



<p><b>3720</b> 2 x LED 4,6W 500mA. Led 2700 K. CRI &gt;90. 868 lm. 93 lm/W. Driver Constant Current 500 mA. 110-240V. 50/60Hz. Dimmer 1-10V + Push.</p>	<p>Diffuser: Blown-glass. Profile: Aluminum. Weight 2,8 Kg.</p>	<p><b>3720 18 /1B</b> Matt graphite lacquer (ADAPTA RF 9913 WX) <input type="radio"/></p> <p><b>3720 93 /1B</b> Matt white lacquer (RAL 9016) <input type="radio"/></p> <p>LED <input type="checkbox"/> <input type="checkbox"/> IP20 <input type="checkbox"/> CE <input type="checkbox"/> Dimmer <input type="checkbox"/> A+ <input type="checkbox"/></p>
<p><b>3724</b> 2 x LED 4,6W 500mA. Led 2700 K. CRI &gt;90. 868 lm. 93 lm/W. Driver Constant Current 500 mA. 110-240V. 50/60Hz. Dimmer 1-10V + Push.</p>	<p>Diffuser: Blown-glass. Profile: Aluminum. Planter: PMMA. Weight 3,3 Kg.</p>	<p><b>3724 18 /1B</b> Matt graphite lacquer (ADAPTA RF 9913 WX) <input type="radio"/></p> <p><b>3724 93 /1B</b> Matt white lacquer (RAL 9016) <input type="radio"/></p> <p>LED <input type="checkbox"/> <input type="checkbox"/> IP20 <input type="checkbox"/> CE <input type="checkbox"/> Dimmer <input type="checkbox"/> A+ <input type="checkbox"/></p>
<p><b>3726</b> 4 x LED 4,6W 500mA. Led 2700 K. CRI &gt;90. 1736 lm. 93 lm/W. Driver Constant Current 500 mA. 110-240V. 50/60Hz. Dimmer 1-10V + Push.</p>	<p>Diffuser: Blown-glass. Profile: Aluminum. Weight 4,1 Kg.</p>	<p><b>3726 18 /1B</b> Matt graphite lacquer (ADAPTA RF 9913 WX) <input type="radio"/></p> <p><b>3726 93 /1B</b> Matt white lacquer (RAL 9016) <input type="radio"/></p> <p>LED <input type="checkbox"/> <input type="checkbox"/> IP20 <input type="checkbox"/> CE <input type="checkbox"/> Dimmer <input type="checkbox"/> A+ <input type="checkbox"/></p>
<p><b>3728</b> 4 x LED 4,6W 500mA. Led 2700 K. CRI &gt;90. 1736 lm. 93 lm/W. Driver Constant Current 500 mA. 110-240V. 50/60Hz. Dimmer 1-10V + Push.</p>	<p>Diffuser: Blown-glass. Profile: Aluminum. Planter: PMMA. Weight 4,7 Kg.</p>	<p><b>3728 18 /1B</b> Matt graphite lacquer (ADAPTA RF 9913 WX) <input type="radio"/></p> <p><b>3728 93 /1B</b> Matt white lacquer (RAL 9016) <input type="radio"/></p> <p>LED <input type="checkbox"/> <input type="checkbox"/> IP20 <input type="checkbox"/> CE <input type="checkbox"/> Dimmer <input type="checkbox"/> A+ <input type="checkbox"/></p>
<p><b>3730</b> 6 x LED 4,6W 500mA. Led 2700 K. CRI &gt;90. 2604 lm. 93 lm/W. Driver Constant Current 500 mA. 110-240V. 50/60Hz. Dimmer 1-10V + Push + DALI</p>	<p>Diffuser: Blown-glass. Profile: Aluminum. Weight 5,4 Kg.</p>	<p><b>3730 18 /1A</b> Matt graphite lacquer (ADAPTA RF 9913 WX) <input type="radio"/></p> <p><b>3730 93 /1A</b> Matt white lacquer (RAL 9016) <input type="radio"/></p> <p>LED <input type="checkbox"/> <input type="checkbox"/> IP20 <input type="checkbox"/> CE <input type="checkbox"/> Dimmer <input type="checkbox"/> A+ <input type="checkbox"/></p>



Pendants



150 cm

3734 p. 55



195 cm

3736 p. 55

3734

1 x LED 2W 500 mA.  
4 x LED 4,6W 500mA.

Led 2700 K. CRI >90. 1829,9 lm. 84,9 lm/W.

Driver Constant Current 500 mA. 110-240V. 50/60Hz.

Dimmer DALI + 1-10V + Push

Diffuser: Blown-glass. Profile: Aluminum.

Planter: PMMA.

Weight 5,5 Kg.

3734 18 /1A Matt graphite lacquer (ADAPTA RF 9913 WX)

3734 93 /1A Matt white lacquer (RAL 9016)



3736

1 x LED 2W 500mA.  
6 x LED 4,6W 500mA.

Led 2700 K. CRI >90. 2730,7 lm. 84,9 lm/W.

Driver Constant Current 500 mA. 110-240V. 50/60Hz.

Dimmer DALI + 1-10V + Push

Diffuser: Blown-glass. Profile: Aluminum.

Planter: PMMA.

Weight 6,6 Kg.

3736 18 /1A Matt graphite lacquer (ADAPTA RF 9913 WX)

3736 93 /1A Matt white lacquer (RAL 9016)



Table

ø 22 cm



3740 p. 65

3740

2 x LED 4,6W 500mA.

Led 2700 K. CRI >90. 868 lm. 93 lm/W.

Driver Constant Current 500 mA. 100-240V. 50/60Hz.

Dimmer Push

Electric cable with plug and push-button

Diffuser: Blown-glass. Profile: Aluminum.

Rods: Steel.

Weight 1,2 Kg.

3740 18 /15 Matt graphite lacquer (ADAPTA RF 9913 WX)

3740 93 /15 Matt white lacquer (RAL 9016)



The contents of this catalogue may be changed or cancelled at the discretion of the VIBIA management without prior notice.

VIBIA se reserva el derecho de efectuar cualquier modificación y anulación de los productos del catálogo vigente sin previo aviso alguno.

Vibia Lighting, S.L.U.

Spain & Portugal T. +34 934 796 970

International T. +34 934 796 971

[vibialighting@vibialighting.com](mailto:vibialighting@vibialighting.com)

[www.vibia.com](http://www.vibia.com)



